

Eckhard Lammert  
Martin Zeeb *Editors*

# Metabolism of Human Diseases

Organ Physiology and Pathophysiology

 Springer

---

# Metabolism of Human Diseases



---

Eckhard Lammert • Martin Zeeb  
Editors

# Metabolism of Human Diseases

Organ Physiology  
and Pathophysiology

 Springer

*Editors*

Eckhard Lammert  
Department of Biology  
Institute of Metabolic Physiology  
German Diabetes Center  
Heinrich Heine University Düsseldorf  
Düsseldorf  
Germany

Martin Zeeb  
CardioMetabolic Diseases Research  
Boehringer Ingelheim Pharma  
GmbH & Co KG  
Biberach  
Germany

ISBN 978-3-7091-0714-0      ISBN 978-3-7091-0715-7 (eBook)  
DOI 10.1007/978-3-7091-0715-7  
Springer Wien Heidelberg New York Dordrecht London

Library of Congress Control Number: 2014940716

© Springer-Verlag Wien 2014

This work is subject to copyright. All rights are reserved by the Publisher, whether the whole or part of the material is concerned, specifically the rights of translation, reprinting, reuse of illustrations, recitation, broadcasting, reproduction on microfilms or in any other physical way, and transmission or information storage and retrieval, electronic adaptation, computer software, or by similar or dissimilar methodology now known or hereafter developed. Exempted from this legal reservation are brief excerpts in connection with reviews or scholarly analysis or material supplied specifically for the purpose of being entered and executed on a computer system, for exclusive use by the purchaser of the work. Duplication of this publication or parts thereof is permitted only under the provisions of the Copyright Law of the Publisher's location, in its current version, and permission for use must always be obtained from Springer. Permissions for use may be obtained through RightsLink at the Copyright Clearance Center. Violations are liable to prosecution under the respective Copyright Law.

The use of general descriptive names, registered names, trademarks, service marks, etc. in this publication does not imply, even in the absence of a specific statement, that such names are exempt from the relevant protective laws and regulations and therefore free for general use.

While the advice and information in this book are believed to be true and accurate at the date of publication, neither the authors nor the editors nor the publisher can accept any legal responsibility for any errors or omissions that may be made. The publisher makes no warranty, express or implied, with respect to the material contained herein.

Printed on acid-free paper

Springer is part of Springer Science+Business Media ([www.springer.com](http://www.springer.com))

---

# Contents

<b>Introduction</b> .....	1
Martin Zeeb and Eckhard Lammert	
<b>Part I Brain</b>	
<b>Overview</b> .....	5
Lorraine V. Kalia	
<b>Major Depressive Disorder</b> .....	11
Donatella Marazziti, Grazia Rutigliano, Stefano Baroni, and Liliana Dell’Osso	
<b>Schizophrenia</b> .....	17
Peter F. Buckley and Adriana Foster	
<b>Epilepsy</b> .....	23
Wesley Plinke and Detlev Boison	
<b>Parkinson’s Disease</b> .....	29
Giulia Ambrosi, Silvia Cerri, and Fabio Blandini	
<b>Alzheimer’s Disease</b> .....	35
Milos D. Ikonovic and Steven T. DeKosky	
<b>Migraine and Cluster Headache</b> .....	41
Massimo Leone and Paola Di Fiore	
<b>Multiple Sclerosis</b> .....	47
Markus Kipp	
<b>Down Syndrome</b> .....	53
Maria D. Torres and Jorge Busciglio	
<b>Part II Eye</b>	
<b>Overview</b> .....	59
Anja Mataruga and Frank Müller	
<b>Age-Related Macular Degeneration</b> .....	67
Monika Fleckenstein and Frank G. Holz	

<b>Glaucoma</b> .....	73
Samuel D. Crish and Christine M. Dengler-Crish	
<b>Part III Teeth and Bones</b>	
<b>Overview</b> .....	81
Kazuhiko Kawasaki and Kenneth M. Weiss	
<b>Dental Caries</b> .....	87
Colin Robinson	
<b>Osteoporosis</b> .....	93
Emmanuel Biver and René Rizzoli	
<b>Part IV Joints</b>	
<b>Overview</b> .....	101
Jessica Bertrand and Jan Hubert	
<b>Osteoarthritis</b> .....	107
Camille Roubille, Johanne Martel-Pelletier, and Jean-Pierre Pelletier	
<b>Rheumatoid Arthritis</b> .....	115
Marianna Meroni, Elena Bernero, and Maurizio Cutolo	
<b>Part V Gastrointestinal Tract</b>	
<b>Overview</b> .....	123
Satish Keshav and Philip Allan	
<b>Peptic Ulcer Disease</b> .....	129
Peter C. Konturek and Stanislaw J. Konturek	
<b>Gastroenteritis</b> .....	137
Christina Quigley and Xi Jiang	
<b>Lactose Intolerance</b> .....	143
Anthony K. Campbell and Stephanie B. Matthews	
<b>Colorectal Cancer</b> .....	149
Kishore Vipperla and Stephen J. O'Keefe	
<b>Part VI Pancreas</b>	
<b>Overview</b> .....	157
Alexandra E. Folias and Matthias Hebrok	
<b>Diabetes Mellitus</b> .....	163
Alena Welters and Eckhard Lammert	

**Part VII Liver**

<b>Overview</b> .....	173
Dieter Häussinger	
<b>Cirrhosis</b> .....	181
Matteo Rosselli and Massimo Pinzani	

**Part VIII Fat Tissue**

<b>Overview</b> .....	191
Gabriele Schoiswohl, Jules Aljammal, and Erin E. Kershaw	
<b>Metabolic Syndrome</b> .....	199
Kana Inoue, Norikazu Maeda, and Tohru Funahashi	

**Part IX Lung**

<b>Overview</b> .....	207
Martin Zeeb, Andreas Schnapp, and Michael-Paul Pieper	
<b>Asthma</b> .....	215
Kenji Izuhara, Shoichi Suzuki, Kazuhiko Arima, Shoichiro Ohta, Masako Inamitsu, and Ken-ichi Yamamoto	
<b>Chronic Obstructive Pulmonary Disease (COPD)</b> .....	221
Irena Konstantinova and Andrew C. Pearce	
<b>Community-Acquired Pneumonia</b> .....	227
Salvador Sialer, Leonardo F. Difrancesco, Teresa Foix Fabregas, and Antoni Torres	

**Part X Heart**

<b>Overview</b> .....	235
Axel Gödecke	
<b>Atherosclerotic Heart Disease</b> .....	243
Massimo Slavich and Juan Carlos Kaski	
<b>Heart Failure</b> .....	251
Roman Pfister and Erland Erdmann	

**Part XI Blood Vessels**

<b>Overview</b> .....	261
Victor W.M. van Hinsbergh, Rick Meijer, and Etto C. Eringa	
<b>Stroke</b> .....	267
Dwi Setyowati Karolina and Kandiah Jeyaseelan	



<b>Varicose Veins</b> . . . . .	273
Rishi Mandavia, Muzaffar A. Anwar, and Alun H. Davies	
<b>Part XII Blood</b>	
<b>Overview</b> . . . . .	281
Deena Iskander and Barbara J. Bain	
<b>Sickle Cell Disease</b> . . . . .	289
Daniel A. Dworkis and Martin H. Steinberg	
<b>Hyperlipidemia</b> . . . . .	295
Paul Durrington and Handrean Soran	
<b>Part XIII Immune System</b>	
<b>Overview</b> . . . . .	305
Christian Münz	
<b>Fever</b> . . . . .	313
Bruno Conti and Tamas Bartfai	
<b>Sepsis</b> . . . . .	319
Jean-Charles Preiser and Jean-Louis Vincent	
<b>Allergies</b> . . . . .	323
Norbert Meyer and James Yun	
<b>Part XIV Kidney</b>	
<b>Overview</b> . . . . .	331
Markus M. Rinschen, Linus A. Völker, and Paul T. Brinkkötter	
<b>Hypertension</b> . . . . .	339
Colleen Flynn and George L. Bakris	
<b>Chronic Kidney Disease</b> . . . . .	345
Golaun Odabaei, George A. Kaysen, and Shubha Ananthakrishnan	
<b>Gout</b> . . . . .	351
Sonia Nasi and Alexander So	
<b>Urinary Tract Infections</b> . . . . .	357
Matt S. Conover, Michael E. Hibbing, and Scott J. Hultgren	
<b>Kidney Stones</b> . . . . .	361
Andreas Neisius and Glenn M. Preminger	

---

**Part XV Reproductive System**

**Overview** ..... 369  
Danny J. Schust and Donald R. Gullicks

**Breast Cancer** ..... 379  
Tanja Fehm and Eugen Ruckhäberle

**Prostate Cancer** ..... 385  
Rahul Aggarwal and Eric Small

**Part XVI Cancer**

**Overview** ..... 393  
Zachary E. Stine and Chi V. Dang

**Index** ..... 401

---

# Introduction

Martin Zeeb and Eckhard Lammert

The scientific community has increasingly recognized metabolic alterations as being critical components or even drivers of human disease. *Metabolism of Human Diseases* discusses the metabolism and signaling pathways in tissues and organs known to be relevant for common human diseases. It thus bridges the existing gap between biochemistry and physiology textbooks, on the one hand, and pathology textbooks, on the other hand.

*Metabolism of Human Diseases* is directed at advanced students, doctors, and scientists from all categories of life sciences and medicine (e.g., biochemists, biologists, physiologists, pharmacologists, pharmacists, toxicologists, and physicians) with an interest in the metabolism and molecular mechanisms of human diseases, irrespective of their specialization.

The book is divided into different parts, each related to a human organ or tissue. Each part begins with an *overview chapter* presenting the anatomic and physiological properties of the organ or tissue in question relevant for the subsequent disease

chapters of the section (Fig. 1). The overview introduces organ- or tissue-specific metabolism and signaling pathways as well as intra- and inter-organ communication (i.e., “inside-in,” “inside-out,” and “outside-in” signaling). The *disease chapters* discuss pathomechanisms of the diseases with emphasis on metabolic alterations and affected signaling pathways. In addition, they briefly introduce major treatments currently in use and in clinical trials as well as their influence on the patient’s metabolism.

The diseases have been selected to cover a wide spectrum of human diseases in the industrialized world (as described in the tenth edition of the International Classification of Diseases, ICD-10). They include many of the most common (based on diagnosis), most deadly (based on numbers of deaths), and most expensive (based on treatment costs) illnesses.

Each chapter of *Metabolism of Human Diseases* contains up to three simplified figures and tables that illustrate important elements of anatomy, physiology, metabolism, signaling pathways, or treatment. All figures are presented in a common layout to facilitate understanding of the contents of each chapter (Fig. 2). Since Yousun Koh provided the layout and final presentation, we would like to express our gratitude to her.

Finally, more than a hundred international experts contributed state-of-the-art chapters to the book, and we would like to thank all of them for their work and dedication.

We wish the owner of the book a pleasant read!

Best regards,

Martin Zeeb and Eckhard Lammert

---

M. Zeeb  
CardioMetabolic Diseases Research,  
Boehringer Ingelheim Pharma GmbH & Co KG,  
Birkendorfer Straße 65,  
88400 Biberach (Riss), Germany  
e-mail: [martin.zeeb@boehringer-ingelheim.com](mailto:martin.zeeb@boehringer-ingelheim.com)

E. Lammert (✉)  
Department of Biology,  
Institute of Metabolic Physiology,  
German Diabetes Center,  
Heinrich Heine University Düsseldorf,  
Universitätsstraße 1, 40225 Düsseldorf, Germany  
e-mail: [lammert@hhu.de](mailto:lammert@hhu.de)

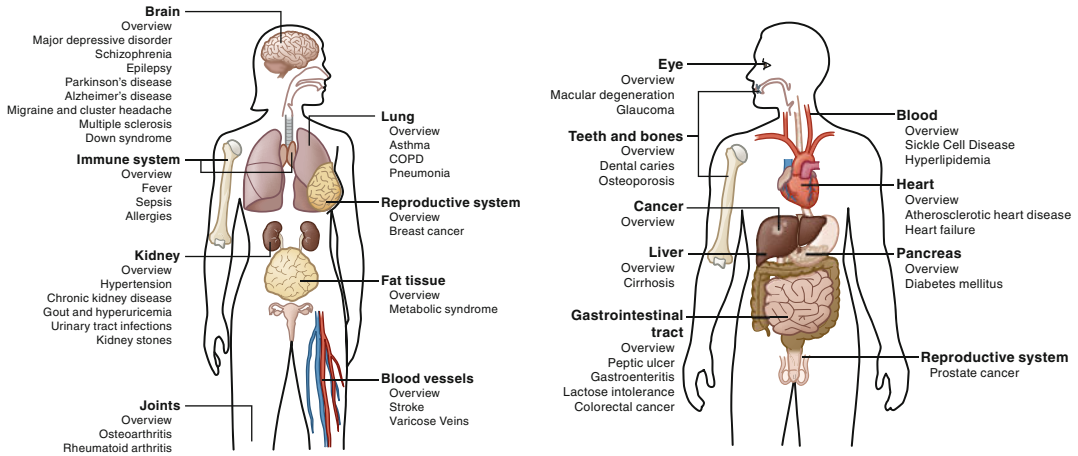

**Fig. 1** Summary of *overview chapters* and *disease chapters*

**Fig. 2** Explanation of symbols (*arrow, dashed arrow, dotted arrow, arrowheads, enzyme brackets, receptor symbol, transporter symbol, activation symbol*) used in this book. Enzymes are marked in *brackets*. Outcomes of treatment are indicated with *light gray arrowheads*

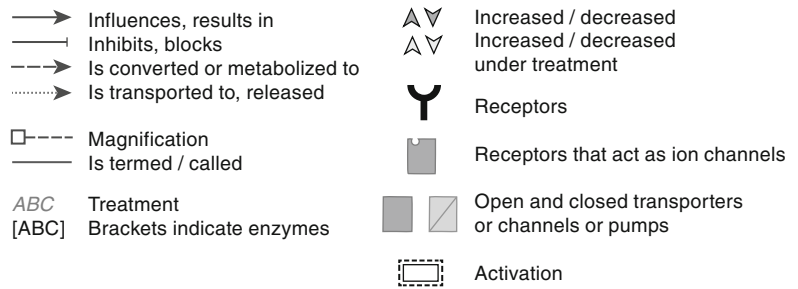

---

**Part I**

**Brain**

---

# Overview

Lorraine V. Kalia

---

## Anatomy and Physiology of the Brain

The brain is a remarkably complex organ both in its structure and function. At the macroscopic level, it can be divided into three major components: (1) brainstem (which includes medulla, pons, and midbrain), (2) cerebellum (with its cortex and deep nuclei), and (3) cerebral hemispheres (which are composed of cerebral cortex, subcortical white matter, basal ganglia and thalamus, limbic system, and hypothalamus and pituitary). The cerebral cortex itself is divided into frontal, parietal, temporal, and occipital lobes (Fig. 1). At the microscopic level, there are two primary cell types: (1) neurons (which receive, process, and transmit information by electrical and biochemical changes mediated, in part, by neurotransmitters) and (2) glia (which are a diverse group of cells with expanding roles in brain function).

The various macroscopic regions of the brain are responsible for different physiological functions. The brainstem contains nuclei required for autonomic functions, such as regulation of heart rate and respiration. Most cranial nerves, which

provide motor and sensory function to structures of the cranium, are also located within the brainstem. These include the trigeminal nerve (cranial nerve V); its sensory portion supplies touch, temperature, and pain sensation to the face, as well as innervates the cerebral vessels to form the trigeminovascular system (see chapter “[Migraine and cluster headache](#)”). The cerebellum functions to coordinate movements. The cerebral cortex contains areas important for motor and sensory functions, as well as association areas, which are required for more complex functions, such as language and executive function. The basal ganglia, including the substantia nigra, are responsible for the control of motor activity (see chapter “[Parkinson’s disease](#)”). The limbic system supports a variety of functions including memory and emotion. It receives inputs from diverse areas of the brain; for example, the mesolimbic system, which plays important roles in reward, motivation, and addiction, is composed of projections from the midbrain to limbic areas (see chapter “[Major depressive disorder](#)”). The thalamus plays a critical relay function by mediating all motor output from and nearly all sensory input to the cortex. The hypothalamus is mainly involved in the regulation of visceral and endocrine activities with the hypothalamus and pituitary being the major hormonal regulators (see chapters “[Major depressive disorder](#)”, “[Rheumatoid arthritis](#)”, and “[Overview](#)” under part “[Reproductive system](#)”).

Optimal brain function requires a well-regulated metabolic environment. Extracerebral

---

L.V. Kalia

Division of Neurology, Department of Medicine, University of Toronto, Toronto, ON M5T 2S8, Canada

Movement Disorders Centre, Toronto Western Hospital, University Health Network, Toronto, ON M5T 2S8, Canada  
e-mail: [lorraine.kalia@utoronto.ca](mailto:lorraine.kalia@utoronto.ca)

**Fig. 1** Basic macroscopic anatomy of the human brain

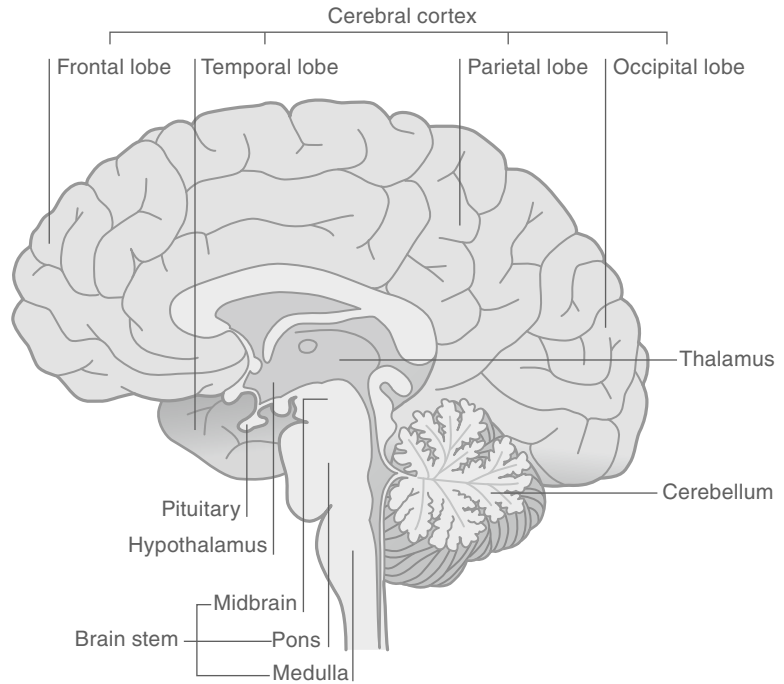

systems remove metabolic products and protect the brain from sudden metabolic perturbations. Necessary nutrients are delivered via the circulation and must cross the blood-brain barrier (BBB), which is formed by endothelial cells lining cerebral microvessels, their basal lamina, and the end-feet of specialized glial cells called astrocytes. Astrocytes and the entire BBB protect neurons from toxic metabolites by preventing their transport into the brain via exclusion or efflux and by neutralizing harmful compounds via uptake or enzymatic inactivation [1]. Neuronal dysfunction and associated neurological diseases can occur when the brain's stable metabolic environment is disrupted.

### Brain-Specific Metabolic/Molecular Pathways and Processes

Neurons are uniquely designed to receive information from the environment or other neurons, process this information, and send information to other neurons or effector tissues (i.e., neurotransmission). The cell body, or soma, contains

the nucleus and additional organelles required for protein synthesis and metabolic maintenance. In most neurons, several dendrites and a single axon extend from the soma. Information is typically transported from the dendrites to the soma to the axon within a neuron by means of electrical events, which are mediated by the opening and closing of specific ion channels. Regulated transport of  $\text{Na}^+$  and  $\text{K}^+$  through the cell membrane is critical. Depolarization of the cell membrane occurs if positive ions ( $\text{Na}^+$ ) enter the cell, whereas hyperpolarization results from exiting of positive ions ( $\text{K}^+$ ) from the cell. When the cell reaches a threshold of depolarization, an electrical signal called an action potential is generated, and this signal is propagated along the length of the axon. At the axon terminal, the neuron communicates with another neuron or an effector tissue within a specialized structure called a synapse. A typical synapse consists of a presynaptic axonal bouton, a postsynaptic dendritic spine, and the intervening space called the synaptic cleft (Fig. 2). Arrival of the action potential at the axonal bouton triggers the release of neurotransmitter from presynaptic vesicles into the synaptic

**Fig. 2** Basic microscopic anatomy of the functional unit of the brain, the synapse. Neurotransmitters are cleared from the synaptic cleft by diffusion, uptake, or degradation. Postsynaptic neurotransmitter receptors are often ion channels or are associated with ion channels

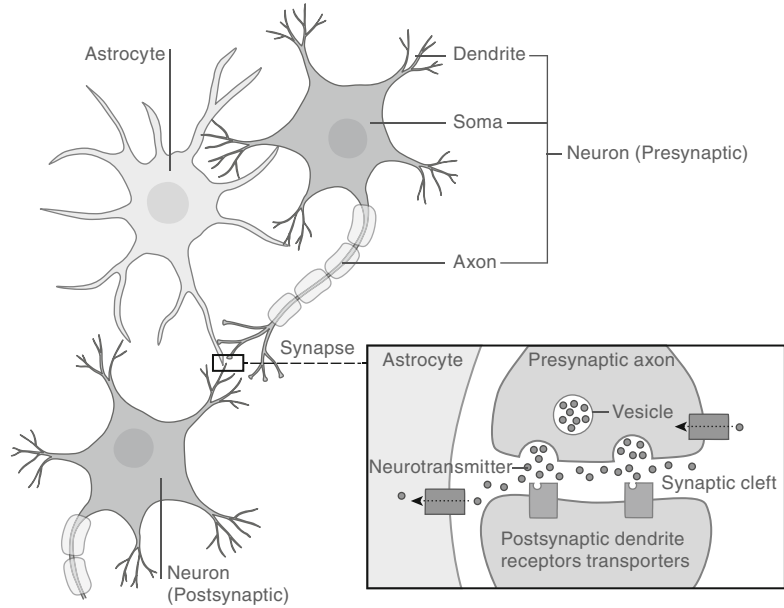

cleft, thereby transforming the electrical signal into a chemical one.

A variety of molecules can act as neurotransmitters: amino acids, such as glutamate (Glu) and  $\gamma$ -aminobutyric acid (GABA), biogenic amines (including acetylcholine, serotonin, and the catecholamines dopamine, epinephrine, norepinephrine), nucleotides (e.g., adenosine), neuropeptides (e.g., substance P), and even gases (e.g., nitric oxide). Neurotransmitters act either directly or indirectly in controlling the opening of ion channels in the postsynaptic neuron or effector tissue (see below). They can be classified based on their effects on the postsynaptic cell; those neurotransmitters that cause depolarization are classified as excitatory, and those that cause hyperpolarization are classified as inhibitory. The major inhibitory neurotransmitter in the brain is GABA, whereas Glu represents the major excitatory neurotransmitter.

To exert their effects on the postsynaptic target, neurotransmitters first traverse the synaptic cleft and then bind to specific postsynaptic receptors. There are two major classes of receptors: ionotropic and metabotropic. Ionotropic receptors are transmembrane proteins with an intrinsic ion channel, which opens upon binding of the neurotransmitter to the receptor's extracellular domain. Metabotropic receptors do not

contain their own ion channel, but neurotransmitter binding can activate intracellular signaling cascades, which produce second messengers that indirectly gate ion channels. Many neurotransmitters utilize postsynaptic receptors from both classes. As an example, Glu receptors include metabotropic Glu receptors, as well as N-methyl-D-aspartate (NMDA) receptor, AMPA receptor, and kainate receptor, which are ionotropic receptors.

The actions of neurotransmitters are terminated by their removal from the synaptic cleft (Fig. 2). Three mechanisms are involved in neurotransmitter removal: diffusion, enzymatic degradation, and reuptake into neurons or uptake into astrocytes. For example, dopamine is cleared from the synaptic cleft by dopamine transporters on the presynaptic neuron or on astrocytes and then degraded by monoamine oxidase B and catechol-O-methyltransferase. The latter also acts to degrade dopamine within the synaptic cleft (see also chapters “[Major depressive disorder](#)” and “[Parkinson's disease](#)”). Similarly, serotonin is removed from the synaptic cleft by a reuptake mechanism as well as degrading enzymes such as monoamine oxidase A (see also chapters “[Major depressive disorder](#)” and “[Migraine and cluster headache](#)”).



## Inside-In: Metabolites of the Brain Affecting Itself

The fundamental metabolic pathways of brain function have been uncovered studying diseases associated with inborn errors of metabolism. These inherited disorders can be classified into three major categories: (1) intoxication disorders (in which there is accumulation of toxic compounds due to a metabolic block (e.g., phenylketonuria)), (2) storage disorders due to abnormal synthesis or degradation of complex molecules (e.g., leukodystrophies), and (3) energy production disorders resulting from deficiencies in energy production or utilization (e.g., mitochondrial disorders) [2]. Because these metabolic pathways are so critical to normal brain function, perturbations due to genetic mutations often result in the manifestation of disease in the neonatal period, infancy, or childhood. However, abnormalities in any of these metabolic pathways due to genetic and/or environmental factors can also lead to neurological disorders in adults.

As an example, energy production abnormalities are common to many neurological disorders, which present in adulthood. The brain is an energy-demanding organ because the metabolic activity of neurons is high (see below). However, the brain's antioxidant capacity is relatively low, which makes it particularly susceptible to oxidative damage. Therefore, the brain is very sensitive to mitochondrial dysfunction, which leads to production of reactive oxygen species and resulting oxidative stress. This is demonstrated by the growing list of neurological diseases in which aberrations in mitochondrial function are implicated, such as Parkinson's disease (see chapter "[Parkinson's disease](#)"), Huntington's disease, and Alzheimer's disease (see chapter "[Alzheimer's disease](#)") [3].

The brain is also sensitive to aberrations in protein homeostasis, or proteostasis. Similar to other cells, neurons possess a variety of cellular systems to manage abnormal or damaging proteins. For instance, a network of interactive molecules known as the chaperone system handles misfolded proteins by refolding the proteins or directing them toward protein elimination

systems including the ubiquitin-proteasome system and autophagy-lysosomal pathway [4]. Impairments in these systems can cause harmful proteins to accumulate within the intracellular or extracellular space resulting in neuronal dysfunction and death. Neurodegenerative diseases are increasingly recognized as disorders of proteostasis and thus are termed proteinopathies. Specific proteins appear to accumulate in different neurodegenerative diseases. For example,  $\alpha$ -synuclein is implicated in Parkinson's disease (see chapter "[Parkinson's disease](#)"),  $\beta$ -amyloid and tau in Alzheimer's disease (see chapter "[Alzheimer's disease](#)"), and prion protein in Creutzfeldt-Jakob disease [5].

---

## Inside-Out: Metabolites of the Brain Affecting Other Tissues

The by-products of neuronal metabolism are currently not known to directly cause disease in other organs. However, the brain indirectly influences metabolism in other parts of the body. On the one hand, the synthesis and release of hormones from the hypothalamus and pituitary regulate the endocrine system; and on the other hand, the action of neurotransmitters mediates neuronal circuits and ultimately regulates behaviors of the organism (e.g., dopamine mediates the reward system which regulates motivational behaviors; see chapter "[Major depressive disorder](#)").

The hypothalamus and pituitary are physically and functionally connected. The pituitary is composed of a posterior lobe and an anterior lobe. The supraoptic and paraventricular nuclei of the hypothalamus synthesize oxytocin and vasopressin (antidiuretic hormone), which are transported to, stored in, and released from the posterior pituitary lobe. The anterior pituitary lobe synthesizes and releases gonadotropins (which influence the gonads, see chapter "[Overview](#)" under part "Reproductive system"), thyrotropin (which influences the thyroid gland), corticotropin (which influences the adrenal glands, see chapters "[Major depressive disorder](#)", "[Rheumatoid arthritis](#)", and "[Chronic kidney disease](#)"), prolactin (which influences the mammillary glands, see

chapter “[Overview](#)” under part “Reproductive system”), and somatotropin/growth hormone (which directly influences adipocytes and the liver, see also chapters “[Overview](#)” under part “Fat tissue” and “[Overview](#)” under part “Liver”). Releasing or inhibiting hormones secreted by the hypothalamus act on the anterior pituitary gland to regulate the release of these hormones into the circulation (see also chapter “[Overview](#)” under part “Reproductive system”).

One of many examples of how the action of neurotransmitters mediates neuronal circuits and thereby regulates behaviors is the dopaminergic reward system, called the mesolimbic pathway. This circuit includes dopaminergic neurons within the medial substantia nigra and ventral tegmental area of the midbrain, which connect to the nucleus accumbens/ventral striatum, as well as limbic structures such as the amygdala and hippocampus. The dopaminergic mesolimbic pathway is involved in diverse motivational behaviors including those related to appetitive and aversive motivational processes [6].

---

### **Outside-In: Metabolites of Other Tissues Affecting the Brain**

The energy demand of the brain is immense and mainly satisfied by consumption of glucose. At rest, the brain accounts for 60 % of the body’s glucose utilization [7]. The majority of energy consumed by the brain is used by neurons for maintenance of the membrane gradient (driving ion pumps necessary for electrical transmission), synthesis and recycling of neurotransmitters, as well as dendritic and axonal transport. Unlike most other tissues, the brain has limited fuel stores and is quite inflexible with regard to substrates for energy metabolism, deriving most of its energy from the oxidation of glucose. Thus, neurons are particularly vulnerable to disruptions in glucose availability. For example, hypoglycemia is associated with aberrations of cerebral function, which can cause an altered mental state depending on severity and duration of glucose deprivation. Hence, nutrition critically influences brain function. This is also illustrated by the use

of the ketogenic diet (the second source of energy neurons are willing to accept) as treatment for epilepsy (see chapter “[Epilepsy](#)”).

Metabolites of other tissues that enter the circulation must be able to cross the BBB to influence brain function. Disorders in which metabolites lead to brain malfunction resulting in altered mental status ranging from a mild confusion to coma are referred to as metabolic encephalopathies. Hypoglycemia can cause such encephalopathy (see above). Abnormalities due to dysfunction in organs such as the kidney and liver may also lead to metabolic encephalopathies. More specifically, elevated ammonia in the brain due to liver failure is a major factor involved in the pathogenesis of hepatic encephalopathy (see chapter “[Cirrhosis](#)”).

Certain hormones synthesized and secreted from peripheral tissues can also cross the BBB. Most hormones exert their influence by acting on various nuclei within the hypothalamus. For example, leptin is a hormone secreted by adipocytes, which acts on the arcuate nucleus and lateral hypothalamic area to suppress appetite (see chapter “[Major depressive disorder](#)”). Gonadal hormones (e.g., estradiol, progesterone, testosterone) and adrenal hormones (e.g., cortisol) circulating in the bloodstream act on the hypothalamus to suppress their own release (negative feedback control of the hypothalamo-pituitary-gonadal and hypothalamo-pituitary-adrenal axis, respectively). Hormones are increasingly found to also have effects on neuronal function in extra-hypothalamic brain areas. This is illustrated by leptin and ghrelin, two peripherally secreted peptide hormones implicated in depression (see chapter “[Major depressive disorder](#)”).

---

### **Final Remarks**

The brain is critical for the survival of the organism, mediating functions and behaviors that range from basic and fundamental to incredibly complex. Yet, the brain is vulnerable to perturbations or defects in metabolism. Some important associations between metabolism and brain disease will be discussed in detail in the following chapters.

## References

1. Abbott NJ, Ronnback L, Hansson E (2006) Astrocyte-endothelial interactions at the blood-brain barrier. *Nat Rev Neurosci* 7:41–53
2. Srour M, Shevell M (2009) Inborn errors of metabolism and developmental delay. In: Shevell M (ed) *Neurodevelopmental disabilities: clinical and scientific foundations*. Mac Keith Press, London
3. Karbowski M, Neutzner A (2012) Neurodegeneration as a consequence of failed mitochondrial maintenance. *Acta Neuropathol* 123:157–171
4. Kalia SK, Kalia LV, McLean PJ (2010) Molecular chaperones as rational drug targets for Parkinson's disease therapeutics. *CNS Neurol Disord Drug Targets* 9:741–753
5. Tyedmers J, Mogk A, Bukau B (2010) Cellular strategies for controlling protein aggregation. *Nat Rev Mol Cell Biol* 11:777–788
6. Salamone JD, Correa M (2012) The mysterious motivational functions of mesolimbic dopamine. *Neuron* 76:470–485
7. Berg JM, Tymoczko JL, Stryer L (2006) *Biochemistry*, 6th edn. W H Freeman, New York

---

# Major Depressive Disorder

Donatella Marazziti, Grazia Rutigliano,  
Stefano Baroni, and Liliana Dell’Osso

---

## Introduction to Depressive Disorders

Depression affects about 121 million people worldwide and is characterized by episodes of affective, somatic, cognitive, and motivational symptoms generally expressed by loss of interest and pleasure with increasing functional impairment, morbidity, and mortality.

Depressed patients die earlier [1] as they show increased risk of cardiovascular disease (CVD) [2] and significant increases in suicide [3]. Interestingly, the association between depression and CVD is likely mediated by metabolic syndrome (MetS, see chapter “[Metabolic syndrome](#)”). Depression clearly correlates with MetS, which is likely the cause for premature CVD. The correlation is bidirectional, as occurrence of depressive episodes is increased in Mets, and symptoms and occurrence of MetS (most commonly visceral obesity and dyslipidemia) are increased in depression [4].

Several subtypes of depression exist, with major differences in metabolic outcome of the disease, i.e., melancholic, atypical, and undifferentiated type. Melancholic depression is generally characterized by anhedonia (from Greek, without pleasure) and is

worse in the morning. It often includes lack of reactivity to pleasurable stimuli, psychomotor also retardation or agitation, loss of appetite or weight, and insomnia. In contrast, atypical depression is worse in the evening and is defined by mood reactivity (mood brightens in response to positive events), appetite and weight increase, and hypersomnia.

Etiology of major depression is still largely unknown, although it is likely associated with the endogenous stress response. Stress response involves several neurotransmitters, such as serotonin (5-hydroxytryptamine, 5-HT), catecholamines (such as norepinephrine (NE), dopamine (DA) and histamine with a stated role in regulation of mood and behavior. Additionally, exposure to prolonged, inescapable stress causes activation of the hypothalamic-pituitary-adrenal (HPA) and sympathoadrenal axis. HPA activation can promote inflammatory response, thus increasing proinflammatory cytokines and production of nitric oxide and reactive oxygen species (ROS), which lead to neuro-metabolic disturbances that are likely involved in the generation of depressive episodes. Inflammation, disturbance of the autonomic nervous system, and neurotransmitter defects are all implicated in depression (Fig. 1) and may cause major metabolic disturbances.

---

## Pathophysiology of Depressive Disorders and Metabolic Alterations

Although a common origin for the different subtypes of depression is likely, they do differ in metabolic outcome and phenotypes. Patients

---

D. Marazziti (✉) • G. Rutigliano • S. Baroni  
L. Dell’Osso  
Dipartimento di Medicina Clinica e Sperimentale,  
University of Pisa, Via Roma, 67, I-56100 Pisa, Italy  
e-mail: [dmarazzi@psico.med.unipi.it](mailto:dmarazzi@psico.med.unipi.it);  
[grazia.rutigliano@hotmail.it](mailto:grazia.rutigliano@hotmail.it); [stefanobaroni@teletu.it](mailto:stefanobaroni@teletu.it);  
[liliana.dellosso@med.unipi.it](mailto:liliana.dellosso@med.unipi.it)

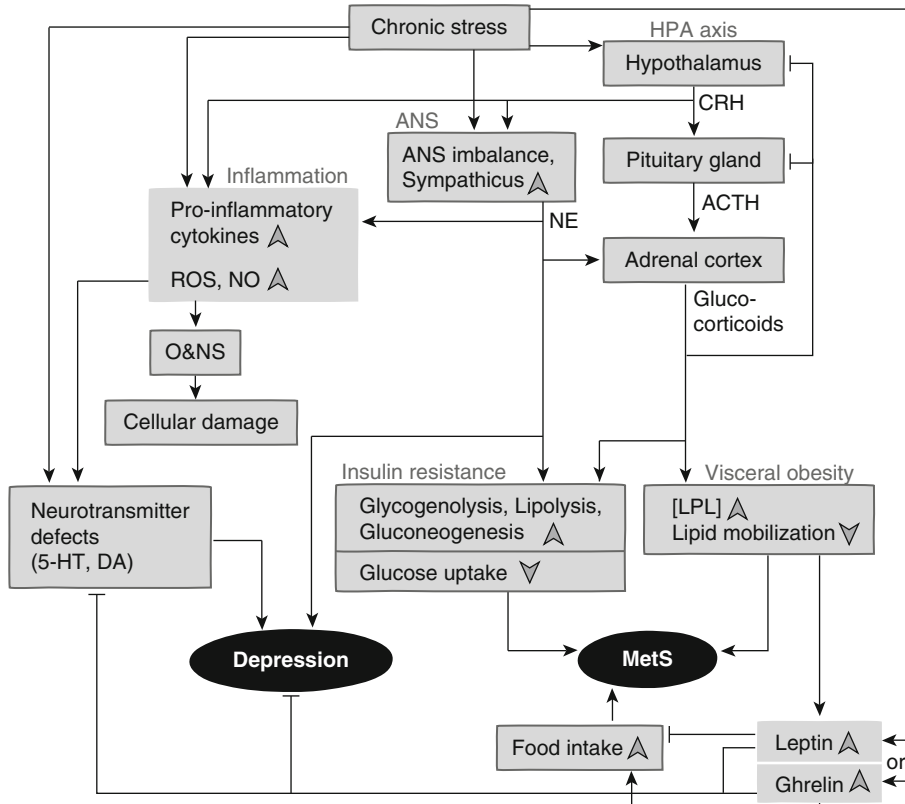

**Fig. 1** Pathophysiological overlap between depression and metabolic syndrome. Depression and metabolic syndrome (*MetS*) share common pathways in the stress system, involving an abnormal activation of the hypothalamus-pituitary-adrenal (*HPA*) axis and an imbalance of the autonomic nervous system (*ANS*). In both conditions, a low-grade systemic inflammation manifests, which leads to enhanced oxidative

and nitrosidative stress (*O&NS*). An antidepressant efficacy has been demonstrated for leptin and ghrelin, two peripheral hormones classically implicated in the homeostatic control of food intake. *NE* norepinephrine, *5HT* serotonin, *DA* dopamine, *CRH* corticotropin-releasing hormone, *ACTH* adrenocorticotrophic hormone, *ROS* reactive oxygen species, *NO* nitric oxide, *LPL* lipoprotein lipase

with atypical and undifferentiated depression show more appetite and subsequently more total and abdominal fat, whereas melancholic patients show reduced weight. It should also be noted that depression has a higher prevalence in women and their health-related risks are likely different than in men. As women tend to react to depressive episodes by hyperphagia, whereas men tend to consume alcohol [5], they show an increased risk for adiposity and thus *MetS* [6].

Several intra- and extracerebral metabolic pathways are changed during depression, which are discussed below.

## Monoamine Systems

The monoamine hypothesis of depression postulates a pathogenic role for disturbances in the monoaminergic systems, involving not only *NE*, *5-HT*, and *DA* but also excitatory and inhibitory amino acids, receptor families, and second messengers. In animal models of chronic stress, neurobehavioral responses are associated with perturbations in monoamines transmission. Reduction in *NE* neurotransmission from the locus ceruleus to the limbic system and the cortex may explain anergia, anhedonia, and diminished libido. *5-HT* transmission is

decreased, due to the depletion of 5-HT stores and increased negative feedback via autoreceptors. Finally, the reduced mesocortical and mesolimbic DA transmission may account for the motivational, cognitive, and motor alterations of depression.

## HPA Axis

Increased HPA activity is present in 20–40 % of depressed inpatients as documented by anatomic, responsive, and biomarker changes (e.g., adrenal and pituitary enlargement, enhanced adrenal response, and increased plasma cortisol levels, respectively). Acute stress triggers the release of corticotropin-releasing hormone (CRH) from the hypothalamus. CRH activates synthesis and release of adrenocorticotrophic hormone (ACTH) from the anterior pituitary, which, in turn, triggers release of cortisol and other glucocorticoids from the adrenal cortex. CRH also enhances pro-inflammatory cytokines and decreases protective neuropeptides [7].

The glucocorticoids hypothesis proposes that melancholic depression results from hyperactivity of CRH neurons, while atypical depression would be based upon increased levels of peripheral corticosteroids, which subsequently suppress CRH (hypoactive HPA axis) [8]. Under acute stress, glucocorticoids mobilize energy for the body's "fight-or-flight" response via gluconeogenesis, glycogenolysis, and lipolysis. Under chronic stress, however, allostatic effects are observed, as the HPA axis is chronically activated and glucocorticoid levels are stably elevated. This activates lipoprotein lipase in visceral fat depots, which accumulates triglycerides in the visceral area (see chapter "Hyperlipidemia") [9]. Increased generation of cortisol from cortisone in visceral fat further amplifies this effect and thus visceral adiposity. Chronically elevated glucocorticoids also contribute to insulin resistance and diabetes, by reducing the translocation of glucose transporters (in particular GLUT4) to the cell surface (see chapter "Diabetes mellitus").

## Autonomic Nervous System

An imbalance favoring sympathetic over parasympathetic activity is a consistent finding in depression (likely caused by chronic stress as well). Heightened sympathetic activity may be mediated by increased NE metabolites [10]. Release of CRH from the hypothalamus and NE from the locus ceruleus coordinates the stress response. Increased sympathetic activity often leads to/causes higher resting heart rates, diminished heart rate variability, and baroreflex dysfunction. It is also proposed to elevate serum insulin and decrease insulin sensitivity [11]. Sympathetic activation enhances release of catecholamines, which increase insulin resistance by reducing uptake of glucose into muscle and subcutaneous fat cells, stimulate release of free fatty acids from fat cells, and increase production of glucose in the liver (via glycogenolysis and gluconeogenesis) [12].

A disturbance in the sympathetic/parasympathetic equilibrium is likewise found in MetS. In healthy individuals, the autonomic balance oscillates between active (catabolic) and inactive (anabolic) periods. In conditions of increased energy intake, parasympathetic activity is increased, in particular in the abdominal compartment, resulting in increased insulin secretion and growth of intra-abdominal fat tissue [13]. On the other hand, due to sedentary lifestyle, sympathetic activity remains high in the skeletal muscle, thus reducing blood flow and glucose uptake by the muscle cells.

## Inflammation

According to the cytokine hypothesis, depression is associated with immunological disturbances, especially increased production of proinflammatory cytokines by lymphocytes. A chronic, systemic low-grade inflammation is found in depression, including cell-mediated immune activation (see chapter "Overview" under part "Immune system") and activation of interferon  $\gamma$ -related pathways [14]. Levels of proinflammatory cytokines, particularly interleukin-1, interleukin-6, tumor necrosis factor- $\alpha$  (TNF- $\alpha$ ;

see also chapter “[Diabetes mellitus](#)”), and cell-mediated macrophage activation, are increased. Interestingly, these cytokines induce degradation of tryptophan, thus reducing the availability of tryptophan and 5-HT. They also inhibit the action of lipoprotein lipase, inducing dyslipidemia (see chapter “[Hyperlipidemia](#)”), and prevent vasodilatation of resistance vessels, predisposing to hypertension (see chapter “[Hypertension](#)”) [15]. Furthermore, TNF- $\alpha$  impairs the function of the insulin receptor and insulin receptor substrate 1 via their phosphorylation, thus contributing to insulin resistance.

## Oxidative Stress

Chronic inflammation depletes the storage of endogenous antioxidants and increases ROS levels, which activate proinflammatory genes. This vicious cycle is called the inflammatory and nitrosidative pathway and leads to increased neurodegeneration [16] and  $\beta$ -cell toxicity. The central nervous system is particularly vulnerable to oxidative stress due to its low expression of antioxidant enzymes (characteristics it shares with pancreatic  $\beta$ -cells), as well as its high content of polyunsaturated fatty acids. Moreover, oxidative stress alters intracellular signaling, most importantly Akt (also called protein kinase B) in the liver leading to aberrant output of glucose and triglycerides. Perturbations in Akt activity are accompanied by impaired insulin-stimulated glucose transport in muscle and adipocytes.

## Peripheral Hormones Leptin and Ghrelin

Leptin is secreted by adipocytes and acts on the hypothalamus to reduce appetite and eating (see chapter “[Diabetes mellitus](#)”). However, obesity induces a state of leptin resistance. As leptin is also involved in mood regulation with an antidepressant effect [17], leptin resistance could underlie depressive symptoms. Thus, the leptin hypothesis of depression is complementary to previous hypotheses. Leptin receptors are present

on 5HT and DA neurons, allowing leptin to modulate the release of these monoamines. Leptin is also known to decrease the release of corticosteroids during the stress response via the HPA axis.

Ghrelin is a gut-derived hormone, which induces a potent feeding response via its receptors in the hypothalamus, and probably mediates hyperphagia in response to stress [18]. Since ghrelin administration produces antidepressant responses, it has been postulated that it helps the organism to cope with stress. In addition, it also activates the dopaminergic reward circuitry, while reinforcing the search for palatable sweet food. Thus, depressed patients may be more susceptible to so-called “Stress eating” [19].

## Association Between Depressive Symptoms and MetS

To date, the exact mechanisms linking MetS to depression are unclear. MetS could be due to the unhealthy lifestyle habits of depressed patients, as it is reduced after adjustment of smoking status, alcohol use, and especially body mass index [20]. However, specific dyslipidemic changes remain associated with corresponding depression subtypes [20]. As it is apparent from the previous sections, MetS and depression share common alterations of the stress system (HPA, inflammation, ROS), indicating a common pathophysiological mechanism (Fig. 1).

## Treatment of Depressive Disorders

Nowadays, several classes of antidepressants are available: tri- and tetracyclic antidepressants (TCAs); selective reuptake inhibitors for 5-HT (SSRIs), NE (NRIs), both 5-HT and NE (SNRIs), and both NE and DA (NDRIs); as well as 5-HT antagonist/reuptake inhibitors (SARIs).

TCAs, named after their chemical structure (e.g., imipramine, amitriptyline), and SSRIs (e.g., fluoxetine, fluvoxamine, citalopram) are still common in pharmacological treatment of depression, with SSRIs becoming favored over TCAs due to fewer side effects (see below).



The general mechanism of TCAs and the reuptake inhibitors is to prevent presynaptic reuptake of monoamines (5-HT, NE, DA), thus increasing their activity in the synaptic cleft. In particular, they ameliorate depressed mood, psychomotor retardation, and suicidal ideation, whereas sleep disturbances, concentration deficits, and lack of interest usually persist. However, acutely enhanced levels of neurotransmitters may lead to adaptive desensitization of postsynaptic neurotransmitter receptors.

Key to management and treatment of depression is the reduction or avoidance of depressive episodes. Yet, metabolic derangements that underlie both depression and MetS should also be screened and targeted, including eating patterns, thyroid dysfunction, body mass index, and fasting blood glucose. These risk factors should also be considered a primary therapeutic target. In mild cases, dietary [21] and exercise [22] intervention improve anxiety, depression, and affective symptoms especially in obese patients, probably normalizing derangements in the HPA axis, peripheral hormones, and inflammation. Furthermore, as additive treatment options, cortisol synthesis inhibitors could dampen the hyperactive HPA axis; anti-inflammatory drugs could decrease inflammatory and nitrosidative pathway-induced damage [16]; and the antidiabetic drug metformin could exert neuroprotective, neurotrophic, and anti-inflammatory effects [23].

---

### **Influence of Treatment on Metabolism**

Several psychotropic drugs are associated with adverse metabolic effects [24] that should be taken into account, especially when dealing with patients with metabolic comorbidity [25].

The classic TCAs, albeit efficacious, exert many undesired pharmacological actions. For example, they block histamine 1 receptors, potentially explaining associated weight gain and dyslipidemia. TCAs may also interfere with insulin secretion, blocking M3 muscarinic acetylcholine receptors in  $\beta$ -cells [26]. TCAs

also activate peripheral  $\alpha 1$  adrenergic receptors, contributing to hypertension (see chapter “Hypertension”) [27].

SSRIs show a more favorable tolerability profile because of their selectivity. However, increased availability of 5-HT may have negative effects as it regulates a multitude of functions, such as sleep, sexual function, and appetite, showing adverse effects on quality of life. Although a weight loss has been observed during early treatment, long-term therapy is associated with significant weight gain.

---

### **Perspectives**

It is predicted that by the year 2020, depression will be the second leading cause of death after CVD. Thus, further targets, possibly within the inflammatory and nitrosidative pathways, should be considered for the treatment of depression in the future: proinflammatory cytokines and their receptors, intracellular inflammatory mediators, glucocorticoid receptors, and neurotrophic factors.

---

### **References**

1. Wulsin LR, Vaillant GE, Wells VE (1999) A systematic review of the mortality of depression. *Psychosom Med* 61:6–17
2. McIntyre RS, Alsuwaidan M, Goldstein BI, Taylor VH, Schaffer A, Beaulieu S, Kemp DE (2012) The Canadian Network for Mood and Anxiety Treatments (CANMAT) task force recommendations for the management of patients with mood disorders and comorbid metabolic disorders. *Ann Clin Psychiatry* 24: 69–81
3. Osby U, Brandt L, Correia N, Ekblom A, Sparen P (2001) Excess mortality in bipolar and unipolar disorder in Sweden. *Arch Gen Psychiatry* 58:844–850
4. Pan A, Keum N, Okereke OI, Sun Q, Kivimaki M, Rubin RR, Hu FB (2012) Bidirectional association between depression and metabolic syndrome: a systematic review and meta-analysis of epidemiological studies. *Diabetes Care* 35:1171–1180
5. McIntyre RS, McElroy SL, Konarski JZ, Soczynska JK, Bottas A, Castel S, Wilkins K, Kennedy SH (2007) Substance use disorders and overweight/obesity in bipolar I disorder: preliminary evidence for competing addictions. *J Clin Psychiatry* 68:1352–1357
6. McIntyre RS, Rasgon NL, Kemp DE, Nguyen HT, Law CW, Taylor VH, Woldeyohannes HO, Alsuwaidan



- MT, Soczynska JK, Kim B, Lourenco MT, Kahn LS, Goldstein BI (2009) Metabolic syndrome and major depressive disorder: co-occurrence and pathophysiological overlap. *Curr Diab Rep* 9:51–59
7. Sadock BJ, Sadock VA (2009) Kaplan & Sadock's comprehensive textbook of psychiatry, 9th edn. Lippincott Williams & Wilkins, Philadelphia
  8. Gold PW, Chrousos GP (2002) Organization of the stress system and its dysregulation in melancholic and atypical depression: high vs low CRH/NE states. *Mol Psychiatry* 7:254–275
  9. Bjorntorp P (2001) Do stress reactions cause abdominal obesity and comorbidities? *Obes Rev* 2:73–86
  10. Golden RN, Markey SP, Risby ED, Rudorfer MV, Cowdry RW, Potter WZ (1988) Antidepressants reduce whole-body norepinephrine turnover while enhancing 6-hydroxymelatonin output. *Arch Gen Psychiatry* 45:150–154
  11. Gans RO (2006) The metabolic syndrome, depression, and cardiovascular disease: interrelated conditions that share pathophysiological mechanisms. *Med Clin North Am* 90:573–591
  12. Benthem L, Keizer K, Wiegman CH, de Boer SF, Strubbe JH, Steffens AB, Kuipers F, Scheurink AJ (2000) Excess portal venous long-chain fatty acids induce syndrome X via HPA axis and sympathetic activation. *Am J Physiol Endocrinol Metab* 279: E1286–E1293
  13. Kreier F, Yilmaz A, Kalsbeek A, Romijn JA, Sauerwein HP, Fliers E, Buijs RM (2003) Hypothesis: shifting the equilibrium from activity to food leads to autonomic unbalance and the metabolic syndrome. *Diabetes* 52:2652–2656
  14. Catena-Dell'Osso M, Rotella F, Dell'Osso A, Fagiolini A, Marazziti D (2013) Inflammation, serotonin and major depression. *Curr Drug Targets* 14:571–577
  15. Yudkin JS, Stehouwer CD, Emeis JJ, Coppack SW (1999) C-reactive protein in healthy subjects: associations with obesity, insulin resistance, and endothelial dysfunction: a potential role for cytokines originating from adipose tissue? *Arterioscler Thromb Vasc Biol* 19:972–978
  16. Catena-Dell'Osso M, Bellantuono C, Consoli G, Baroni S, Rotella F, Marazziti D (2011) Inflammatory and neurodegenerative pathways in depression: a new avenue for antidepressant development? *Curr Med Chem* 18:245–255
  17. Lutter M, Elmquist J (2009) Depression and metabolism: linking changes in leptin and ghrelin to mood. *F1000 Biol Rep* 1:63
  18. Lutter M, Sakata I, Osborne-Lawrence S, Rovinsky SA, Anderson JG, Jung S, Birnbaum S, Yanagisawa M, Elmquist JK, Nestler EJ, Zigman JM (2008) The orexigenic hormone ghrelin defends against depressive symptoms of chronic stress. *Nat Neurosci* 11:752–753
  19. Skibicka KP, Hansson C, Egecioglu E, Dickson SL (2012) Role of ghrelin in food reward: impact of ghrelin on sucrose self-administration and mesolimbic dopamine and acetylcholine receptor gene expression. *Addict Biol* 17:95–107
  20. van Reedt Dortland AK, Giltay EJ, van Veen T, Zitman FG, Penninx BW (2010) Metabolic syndrome abnormalities are associated with severity of anxiety and depression and with tricyclic antidepressant use. *Acta Psychiatr Scand* 122:30–39
  21. Sanchez-Villegas A, Delgado-Rodriguez M, Alonso A, Schlatter J, Lahortiga F, Serra Majem L, Martinez-Gonzalez MA (2009) Association of the Mediterranean dietary pattern with the incidence of depression: the Seguimiento Universidad de Navarra/University of Navarra follow-up (SUN) cohort. *Arch Gen Psychiatry* 66:1090–1098
  22. Dunn AL, Trivedi MH, Kampert JB, Clark CG, Chambliss HO (2005) Exercise treatment for depression: efficacy and dose response. *Am J Prev Med* 28:1–8
  23. Ehret M, Goethe J, Lanosa M, Coleman CI (2010) The effect of metformin on anthropometrics and insulin resistance in patients receiving atypical antipsychotic agents: a meta-analysis. *J Clin Psychiatry* 71:1286–1292
  24. Chokka P, Tancer M, Yeragani VK (2006) Metabolic syndrome: relevance to antidepressant treatment. *J Psychiatry Neurosci* 31:414
  25. Kozumplik O, Uzun S (2011) Metabolic syndrome in patients with depressive disorder—features of comorbidity. *Psychiatr Danub* 23:84–88
  26. McIntyre RS, Soczynska JK, Konarski JZ, Kennedy SH (2006) The effect of antidepressants on lipid homeostasis: a cardiac safety concern? *Expert Opin Drug Saf* 5:523–537
  27. Licht CM, de Geus EJ, Seldenrijk A, van Hout HP, Zitman FG, van Dyck R, Penninx BW (2009) Depression is associated with decreased blood pressure, but antidepressant use increases the risk for hypertension. *Hypertension* 53:631–638

---

# Schizophrenia

Peter F. Buckley and Adriana Foster

---

## Introduction to Schizophrenia

Schizophrenia is the most serious and disabling of all mental disorders, affecting just under 1 % of the population. While its etiological bases remain obscure and consequently its nosological boundaries are uncertain, the condition classically has its onset in childhood or early adolescence [1]. It is characterized by (1) “positive” psychotic symptoms like delusions (fixed false ideas that are held with unshakable conviction), hallucinations (perceptions without a stimulus), and thought disorder (difficulty in assembling a coherent stream of speech); (2) so-called negative symptoms like lack of motivation and pleasure, inability of expressing the full range of emotions, neglect of personal appearance, and disinterest in life events; and (3) cognitive impairment (memory and attention difficulties) [2]. All of these attributes, persistent over time, culminate in a decline in social and occupational performance. These features – coupled with the consequences of sustained impairment – result in comorbid depression (see chapter “[Major depressive disorder](#)”) among people with schizophrenia. Approximately 50 % of patients attempt and about 4 % of patients commit suicide. Schizophrenia is poorly understood by the public, and it is often highly stigmatizing [3].

---

P.F. Buckley, MD (✉) • A. Foster, MD  
Department of Psychiatry and Health Behavior,  
Medical College of Georgia,  
Georgia Regents University,  
1120 15th St., AA 1002, Augusta, GA 30912, USA  
e-mail: [pbuckley@gru.edu](mailto:pbuckley@gru.edu); [afoster@gru.edu](mailto:afoster@gru.edu)

---

## Pathophysiology of Schizophrenia and Metabolic Alterations

The causes of schizophrenia are largely unknown [4, 5]. However, an ever-increasing portfolio of extensive, multinational genetic studies point to subtle yet reproducible genetic findings [6, 7]. Replicated genes like COMT (catechol-O-methyltransferase), implicated in dopamine and norepinephrine degradation, neuregulin-1 implicated in expression and activation of neurotransmitter receptors, including glutamate, dysbindin gene, DISC (disrupted in schizophrenia), DRD2 (dopamine receptor D2), and DAT (dopamine active transporter), likely represent only a minor part of genetic makeover of schizophrenia, while genome-wide studies reveal DNA variants (single nucleotide polymorphisms), which are common to schizophrenia and bipolar disorder, and structural genomic variants (copy number variants) shared by schizophrenia and neurodevelopmental disorders like autism [6].

Nongenetic influences include obstetric events like hypoxia and maternal malnutrition, birth during late winter and spring, advanced paternal age, urbanity, prenatal infections (such as rubella and maternal influenza), changes in inflammatory markers like cytokines, head injury, and use of cannabis [8].

The exact mixture and confluence of etiological factors that result in schizophrenia most likely differs from one patient to another [5]. On postmortem brain, patients with schizophrenia reveal a series of macroscopic and histological

abnormalities. The overall brain volume is reduced (by around 5 %, in both white and gray matter), and the temporal and frontal lobes are smaller. In addition, the hippocampus is smaller, with predominance of finding more left-sided reductions. In contrast, the ventricles (especially the lateral ones) are enlarged. On a cellular level, changes more of attuned arrangement rather than fundamental tissue loss or necrosis are observed, likely resulting from convergence of genetic and environmental factors, leading to abnormal neuronal connectivity and synaptic signaling and altering dopaminergic and glutamatergic pathways of neurotransmission in the brain.

Altered dopaminergic function is considered as the final common pathway in schizophrenia [1]. This hypothesis has most influenced antipsychotic drug development and the clinical treatment of schizophrenia, and it represents the best (yet still inadequate) explanatory model for schizophrenia and its treatment. According to this hypothesis, in schizophrenia, the mesolimbic dopamine pathway, believed to have a role in thought and perception, is disrupted, especially through dopamine receptor D2 (DRD2)-mediated effects. An overactivation of this receptor is a compelling pathobiological finding in schizophrenia. The hypothesis also explains other schizophrenia characteristics, as dopamine pathways in the brain affect cognition (through a mesocortical pathway, which is important in the flow of information in the frontal lobe), movement through the nigrostriatal pathway, which is instrumental as part of the basal ganglia motor loop, and endocrine function through the tuberoinfundibular pathway, which involves dopamine acting as an inhibitor of prolactin gene expression and secretion.

Other emergent hypotheses include an oxidative stress and phospholipid dysregulation hypothesis, a glutamate hypothesis [9], and a more “all-encompassing” neurodevelopmental hypothesis of schizophrenia [1, 8], which capitalize on the fact that the pathological brain abnormalities thought to be resulting from the gene-environmental factors implicated in schizophrenia (smaller prefrontal cortex and hippocampus, enlarged ventricles) appear to be static in nature,

at least in a subgroup of patients, and occur without evidence of gliosis, commonly found in neurodegenerative disorders. More recent drug development is focusing on the glutamate system as novel and potentially (more) effective way to treat schizophrenia [9]. Schizophrenia has been associated with metabolic abnormalities independent of treatment with antipsychotic drugs; for example, treatment-naïve patients with schizophrenia have increased prevalence of abnormal glucose tolerance and insulin resistance compared to normal controls [10, 11].

---

## Treatment of Schizophrenia

Antipsychotic medications form the bedrock of treatment for schizophrenia [12]. All these medications block dopamine (D2) receptors to some extent, although newer antipsychotic medications tend to have broader effects that extend to other (e.g., cholinergic, adrenergic, serotonergic) neurotransmitters. Antipsychotic medications should be used in all florid psychosis, except drug-induced psychosis and brief psychosis [12, 13].

Antipsychotic drugs are grouped into a first- and second-generation antipsychotics (FGAs and SGAs), based on their receptor and adverse effect profiles. When starting schizophrenia treatment (usually with a second-generation antipsychotic), the lowest effective drug dose should be used. Antipsychotic drugs often appear to work in about 48 h, although it may take up to 4 weeks at adequate dose to determine whether the drug is ultimately effective. Treatment response, tolerability, and side effects of any given drug are highly variable between patients [14], and side effects should thus be monitored closely. Switching antipsychotic medications may be indicated, for either lack of effect or presence of side effects on the present medications, although it is a complicated process and the switch to a new medication should be gradual and phased-in with a cross taper. Antipsychotic polypharmacy is common although probably not justified. At present, treatment remains a clinical approach of “trial and error” with the selection of each antipsychotic medication. The mechanism of action of the FGAs

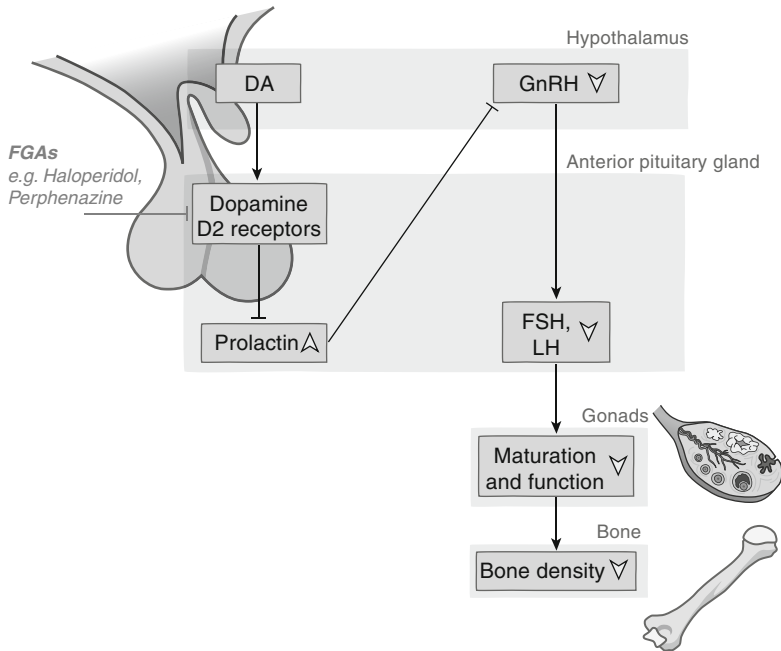

**Fig. 1** Potential mechanism of side effects of antipsychotics on gonadal system and bone structure. First-generation antipsychotics (FGAs) act by inhibiting the binding of dopamine (DA), released from the hypothalamus, to D2 receptors in the pituitary gland. Without this activation, the DA block of prolactin secretion is released.

Increased prolactin can lead to gonadal dysfunction, via reduced amounts of gonadotropin-releasing hormone (*GnRH*), follicle-stimulating hormone (*FSH*), and luteinizing hormone (*LH*). Subsequently, gonadal failure can cause bone loss and osteoporosis

(e.g., haloperidol and perphenazine) is based primarily on the inhibition of dopamine D2 receptors. Clozapine, the initial SGA drug, only partially binds to dopamine D2 receptors. However, it also binds dopamine D4 receptors with high affinity. Other targets include dopamine D1, D3, and D5 receptors as well as serotonin, adrenergic, and histaminergic receptors. Other SGAs (like risperidone, quetiapine, and olanzapine) maintain the combined inhibition of dopamine D2 receptors and serotonin 5-HT<sub>2A</sub> receptors [14].

## Influence of Treatment on Metabolism

As dopamine affects many neurological systems in the brain (see above), antipsychotic and anti-dopaminergic treatments have broad therapeutic and adverse effects. Based on the all-encompassing hypothesis, there is some evidence

that medications may have neuroplastic effects [15]. On the other hand, there is lingering concern that antipsychotic medications might be neurotoxic and thereby contribute to progressive neurodegeneration in schizophrenia [16].

The FGAs have a side effect profile largely characterized by acute and long-term muscle impairments through their effect on the dopaminergic nigrostriatal pathway. In addition, FGAs, which antagonize the action of dopamine, which is also known as prolactin-inhibiting hormone (see chapter “[Overview](#)” under part “[Reproductive system](#)”), induce hyperprolactinemia by releasing the dopamine block of prolactin secretion in the pituitary gland. This can lead to gonadal failure and subsequently to bone loss and osteoporosis (see chapter “[Osteoporosis](#)”, Fig. 1) [17, 18].

SGAs show a more complex side effect profile that is increasingly characterized by metabolic disturbances [19]. While they yield less risk for movement disorders and hyperprolactinemia,

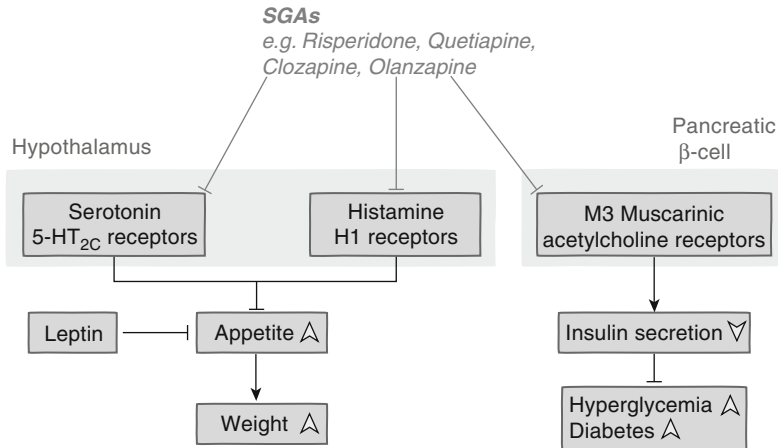

**Fig. 2** Side effect profile of second-generation antipsychotics. Second-generation antipsychotics (SGAs) show side effects different from the first generation due to their binding to 5-HT<sub>2C</sub> dopamine (5-HT) and H1 histamine receptors in the hypothalamus (*left side*) and M3 muscarinic acetylcholine receptors on pancreatic  $\beta$ -cells

(*right side*). Blockade of 5-HT<sub>2C</sub> and H1 receptors releases the inhibitory effect on appetite that these receptors share with leptin. Increased appetite results in weight gain and associated effects. Blockade of M3 receptors may reduce insulin secretion and subsequently cause hyperglycemia and diabetes

due to lower blockade of dopamine D2 receptors and concomitant serotonin antagonism, SGAs are known to induce dangerous metabolic effects [20], for example, weight gain, and alterations in glucose and lipid metabolism. SGAs increase appetite activating histamine H1 and serotonin 5-HT<sub>2C</sub> receptors [20]. Serotonin 5-HT<sub>2C</sub> receptors and leptin, a hormone implicated in the pathophysiology of food and energy regulation (see chapters “[Diabetes mellitus](#)” and “[Metabolic syndrome](#)”), have been associated with weight gain in replicated studies and may provide a basis for individualized adverse effect risk assessment in the future (Fig. 2) [21]. Therefore, guidelines on monitoring patients on antipsychotics for obesity, diabetes, lipid abnormalities, and cardiovascular risk have been issued [22, 23].

## Perspectives

In addition to the use of FGAs and SGAs in the treatment of schizophrenia, there are a variety of other novel approaches targeting specific aspects of the illness, e.g., treatment of negative symptoms, and treatment of cognitive impairments. The field is still awaiting a third generation of

drugs for schizophrenia, which can exercise therapeutic effect without considerable metabolic and endocrine risk [24]. Pharmacogenetic analyses have offered some insights into effectiveness, tolerability, and side effects in individual patients. However, the predictive potential to drive “personalized medicine” is still a long way off [25].

Although medications form the basis of treatment, medications alone are insufficient for treating schizophrenia. Other psychological and cognitive approaches (such as cognitive therapy adapted for schizophrenia and cognitive remediation training particularly when combined with functional adaptation skills training [26]) are important and impactful treatment modalities [27].

Research also focuses on earlier diagnosis and treatment of schizophrenia, thereby intuitively leading to better results and less secondary consequences of protracted psychosis. Indeed, research points to subtle signs of psychosis in advance of more florid psychotic manifestations [28]. Moreover, many of the neurobiological hallmarks of schizophrenia such as decreased gray matter in the temporal, frontal, and cingulate cortex as well as subtle clinical symptoms like attention difficulty, cognitive decline, social withdrawal, and affective flattening exist in early

states, albeit in much more attenuated forms [29]. Unfortunately, identification and clinical incorporation of disease biomarkers that could inform and reliably predict treatment outcomes prove difficult [30]. Moreover, the lack of fundamental understanding of the pathobiology of schizophrenia greatly hampers this quest.

## References

1. Van Os J, Kapur S (2009) Schizophrenia. *Lancet* 374:635–645
2. Tandon R (2013) Schizophrenia and other psychotic disorders in *DSM-5*: clinical implications of revisions from *DSM-IV*. *Clin Schizophr Relat Psychoses* 7:16–19
3. Pescosolido BA, Medina TR, Martin JK, Long JS (2013) The “backbone” of stigma: identifying the global core of public prejudice associated with mental illness. *Am J Public Health* 103:853–860
4. Tandon R, Nassrallah HA, Keshavan MS (2012) Schizophrenia: just the facts 5. Treatment and prevention. Past, present, and future. *Schizophr Res* 122: 1–23
5. McGrath J, Meyer-Lindenberg A (2013) Is it time schizophrenia research left the museum? *Clin Schizophr Relat Psychoses* 6:170–171
6. Owen MJ (2012) Implications of genetic findings for understanding schizophrenia. *Schizophr Bull* 38: 904–907
7. Cross-Disorder Group of the Psychiatric Genomics Consortium (2013) Genetic Risk Outcome of Psychosis (GROUP) Consortium. Identification of risk loci with shared effects on five major psychiatric disorders: a genome-wide analysis. *Lancet* 381(9875):1371–1379
8. Piper M, Beneyto M, Burne T, Eyles D, Lewis D, McGrath J (2012) The neurodevelopmental hypothesis of schizophrenia: convergent clues from epidemiology and neuropathology. *Psychiatr Clin North Am* 35:571–584
9. Jevitt D (2012) Twenty-five years of Glutamate and schizophrenia: are we there yet? *Schizophr Bull* 38:911–913
10. Fernandez-Egea E, Bernardo M, Donner T et al (2009) Metabolic profile of antipsychotic-naïve individuals with non-affective psychosis. *Br J Psychiatry* 194:434–438
11. Dasgupta A, Singh OP, Rout JK et al (2010) Insulin resistance and metabolic profile in antipsychotic naïve schizophrenia patients. *Prog Neuropsychopharmacol Biol Psychiatry* 34:1202–1207
12. Hasan A, Falkai P, Wobrock T, Lieberman J, Glenthøj B, Gattaz WF, Thibaut F, Möller HJ (2012) World Federation of Societies of Biological Psychiatry (WFSBP). Guidelines for Biological Treatment of Schizophrenia, part 1: update 2012 on the acute treatment of schizophrenia and the management of treatment resistance. *World J Biol Psychiatry* 13:318–378
13. Buchanan RW, Kreyenbuhl J, Kelly DL, Noel JM, Boggs DL, Fischer BA, Himmelhoch S, Fang B, Peterson E, Aquino PR, Keller W, Schizophrenia Patient Outcomes Research Team (PORT) (2010) The 2009 schizophrenia PORT psychopharmacological treatment recommendations and summary statements. *Schizophr Bull* 36:71–93
14. Leucht S, Cipriani A, Spineli L et al (2013) Comparative efficacy and tolerability of 15 antipsychotic drugs in schizophrenia: a multiple treatments meta-analysis. *Lancet* 382:951–962
15. Ho BC, Andreasen NC, Ziebell S, Pierson R, Vincent M (2011) Long term antipsychotic treatment and brain volumes: longitudinal study of first episode schizophrenia. *Arch Gen Psychiatry* 68: 128–137
16. Ronopaske GT, Dorph-Peterson KA, Sweet RA (2008) Effects of antipsychotic exposure on astrocyte and oligodendrocyte numbers in macaque monkeys. *Biol Psychiatry* 63:758–765
17. Howard L, Kirkwood G, Leese M (2007) Risk of hip fracture in patients with a history of schizophrenia. *Br J Psychiatry* 190:129–134
18. Inder WJ, Castle D (2011) Antipsychotic-induced hyperprolactinemia. *Aust N Z J Psychiatry* 45: 830–837
19. Buckley PF, Miller B, Singer B, Arena J, Stirewalt EM (2005) Clinicians’ recognition of the metabolic adverse effects of antipsychotic medications. *Schizophr Res* 79:281–288
20. Pramyothin P, Khaodhiar L (2010) Metabolic syndrome with the atypical antipsychotics. *Curr Opin Endocrinol Diabetes Obes* 17:460–466
21. Arranz MJ, Rivera M, Munro C (2011) Pharmacogenetics of Response to Antipsychotics in Patients with Schizophrenia. *CNS Drugs* 25: 933–969
22. American Diabetes Association, American Psychiatric Association, American Association of Clinical Endocrinologists, North American Association for the Study of Obesity (2004) Consensus Development Conference on antipsychotic drugs and obesity and diabetes. *Diabetes Care* 27:596–601
23. De Hert M, Dekker JM, Wood D et al (2009) Cardiovascular Disease and diabetes in people with severe mental illness position statement from the European Psychiatric Association (EPA), Supported by the European Association for the study of Diabetes (EASD) and the European Society of Cardiology. *Eur Psychiatry* 24:412–424
24. Dean OM, Data-Franco J, Giorlando F, Berk M (2012) Minocycline: therapeutic potential in psychiatry. *CNS Drugs* 26:391–401
25. Foster BA, Buckley PF. Pharmacogenetics of treatment refractory schizophrenia: in treatment refractory schizophrenia a clinical conundrum. In: Buckley PF, Graygran F (eds). Springer (in press)

26. Keefe RS, Harvey PD (2012) Cognitive impairment in schizophrenia. *Handb Exp Pharmacol* 213: 11–37
27. Harvey PD, Bowie R (2012) Cognitive enhancement in schizophrenia: pharmacological and remediation approaches. *Psychiatr Clin North Am* 35: 683–698
28. Fusar-Poli P, Borgwardt S, Bechdolf A, Addington J, Riecher-Rossler A, Schultze-Lutter F et al (2013) The psychosis high-risk state: a comprehensive state-of-the-art review. *JAMA Psychiatry* 70: 107–120
29. Kerns J, Lauriello J (2012) Can structural neuroimaging be used to define phenotypes and course of schizophrenia? *Psychiatr Clin North Am* 35:633–644
30. Weickert CS, Weickert T, Pillai A, Buckley PF (2013) Biomarkers for schizophrenia: a brief conceptual consideration. *Dis Markers* 35:3–9

---

# Epilepsy

Wesley Plinke and Detlev Boison

---

## Introduction to Epilepsy

Epilepsy is a complex syndrome comprised of seizures and associated comorbidities affecting approximately 50 million people worldwide. The disease is characterized by excessive electrical discharges in hyperexcitable neuronal clusters that result in spontaneous and recurrent seizures. The seizures may be subclinical and thus only apparent on an electroencephalogram (EEG), but more often they fit into two clinical classifications: partial and generalized. Partial seizures have a focused origin in the brain, and, therefore, seizure symptoms may present in a localized manner. Generalized seizures lack a focal origin and instead involve the entire brain. Epileptic seizures can range from altered states of consciousness to those involving motor function with clonic and/or tonic components.

Our understanding of the pathophysiological processes that turn a normally functioning brain into a hyperexcitable one remains limited. Many theories exist to explain the apparent disruption of homeostatic functions that alter neuronal excitation and/or inhibition. Research has thus far examined extracellular ion homeostasis,

altered energy metabolism, changes in receptor function, and alterations in transmitter uptake.

---

## Pathophysiology of Epilepsy and Metabolic Alterations

Epileptic seizures result from significant electrical discharges in hyperexcitable groups of neurons in which the normal neurophysiology is pathologically altered to favor excitation over inhibition. This can be caused by decreased inhibitory or increased excitatory signals or altered response to these input signals, all of which probably contribute to the etiology of epilepsy.

Within neurons, altered functions of ion channels, such as those controlling the flux of  $\text{Ca}^{2+}$ ,  $\text{K}^{+}$ , or  $\text{Na}^{+}$ , a decrease in inhibitory  $\gamma$ -aminobutyric acid (GABA) signaling, or an excess in glutamatergic excitatory signaling, all contribute to the hyperexcitable state of neuronal networks. Those mechanisms generally decrease the threshold for neuronal activation, and, thus, stimuli that normally are subthreshold are now able to trigger excessive excitation. Another feature of epileptogenic groups of neurons is synchrony, which is favored by altered neuronal connectivity leading to recurrent circuitry.

Recent evidence suggests that neuronal hyperexcitability in epilepsy is not only an intrinsic deficiency of neurons but to a large degree determined by the disruption of homeostatic and metabolic functions, which are controlled by astrocytes (Fig. 1) [1]. Many forms of epilepsy,

---

W. Plinke • D. Boison (✉)  
Robert Stone Dow Neurobiology Laboratories,  
Legacy Research Institute,  
1225 NE 2nd Ave, Portland, OR 97232, USA  
e-mail: [wplinke@downeurobiology.org](mailto:wplinke@downeurobiology.org);  
[dboison@downeurobiology.org](mailto:dboison@downeurobiology.org)



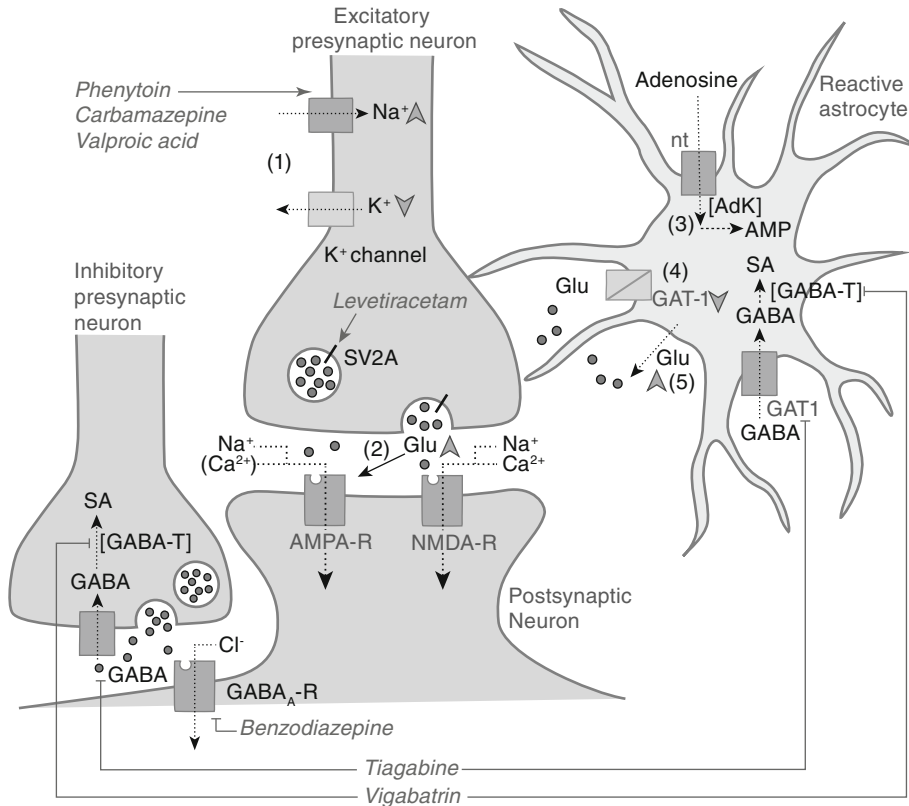

**Fig. 1** Disruption of multiple systems in epilepsy involving neurons and astrocytes. (1) Hyperexcitable neurons are associated with overactivation of voltage-gated  $\text{Na}^+$  channels and reduced activity of  $\text{K}^+$  channels, which generate an action potential that leads to (2) increased release of glutamate (*Glu*). This activates AMPA and *N*-methyl-D-aspartate (*NMDA*) receptors on the postsynaptic membrane, causing excitatory synaptic potentials. (3) Upregulated adenosine kinase (*AdK*) in reactive astrocytes increases the removal of extracellular adenosine, enhancing hyperexcitability. (4) Decreased membrane

transporters for  $\text{K}^+$  (not shown) and *Glu* (such as *GAT-1*) on reactive astrocytes further enhance hyperexcitability. (5) Excessive  $\text{Ca}^{2+}$  intake in astrocytes even induces *Glu* release. Points of interference of a few antiepileptic drugs are also shown. These drugs generally aim to decrease hyperexcitability by reducing glutamate release or signaling or by increasing glutamate removal or inhibitory signaling. *SV2A* synaptic vesicle glycoprotein 2A, *nt* nucleoside transporter, *GABA*  $\gamma$ -aminobutyric acid, *GAT-1* GABA transporter-1, *GABA-T* GABA transaminase, *SA* succinic semialdehyde

particularly those involving the temporal lobe, are characterized by astrogliosis, a macroglial response that leads to increased proliferation and hypertrophy of astrocytes. Astrogliosis in turn is associated with changes in the membrane conductance for ions, which limits the buffering capacity of astrocytes for  $\text{K}^+$ ,  $\text{Ca}^{2+}$ , and  $\text{H}^+$ , and disrupts the homeostasis of neurotransmitters such as glutamate (*Glu*) and of neuromodulators such as adenosine. As a consequence of those alterations in astroglial physiology, the extracellular concentrations of  $\text{K}^+$  and *Glu* are increased, whereas those of adenosine are decreased. In

particular, overexpression of adenosine kinase, the key enzyme for the metabolic clearance of adenosine through astrocytes, has been identified as a key pathological hallmark of epilepsy as it results in adenosine deficiency [2].

Adenosine is a key link between energy homeostasis and metabolic activity and has been termed a “retaliatory metabolite” due to its capability to adjust energy consumption to energy supplies [3]. In general, under any conditions of stress or distress, the levels of adenosine rise, and it is this rise in adenosine that limits further neuronal energy consumption [4] by binding to

inhibitory adenosine A<sub>1</sub> receptors [5], which couple to inhibitory G<sub>i</sub> and G<sub>o</sub> proteins and thereby (1) lead to a decrease in the intracellular messenger cAMP, (2) induce neuronal hyperpolarization by augmenting G protein-coupled inwardly rectifying K<sup>+</sup> channels, and (3) induce presynaptic inhibition by limiting Ca<sup>2+</sup> influx into the presynaptic neuron. More specifically, in epilepsy, seizures consume a large amount of energy, which leads to a rise in adenosine that acts as an endogenous anticonvulsant and seizure terminator [6].

---

## Treatment of Epilepsy

Treatment of epilepsy with antiepileptic drugs (AEDs) generally attempts to correct the disruption in normal electrical functionality via decreases in excitatory processes or increases in inhibitory processes. AEDs aim to reduce seizures by regulating the nervous system's primary excitatory neurotransmitter, Glu, its primary inhibitory neurotransmitter, GABA, or ion channels that control the conduction of electrical impulses in neurons. It should be noted, however, that the treatment of epilepsy, based on the modulation of neuronal downstream targets, fails to control seizures in more than 30 % of patients with epilepsy [7, 8]. The control of neuronal excitability by blockade of ion channels such as those for Na<sup>+</sup>, K<sup>+</sup>, and Ca<sup>2+</sup> is a mechanism of commonly used AEDs (e.g., phenytoin, carbamazepine, valproic acid). Newer AEDs act by interfering with the synthesis, function, release, and metabolism of neurotransmitters and their receptors. Levetiracetam binds to the synaptic vesicle glycoprotein SV2A and inhibits presynaptic Ca<sup>2+</sup> channels. Presynaptic mechanisms are thought to impede impulse conduction across synapses. Vigabatrin blocks GABA transaminase, the major GABA degrading enzyme, and tiagabine blocks reuptake of GABA via GABA transporter 1 (GAT1), thereby increasing the level of extracellular GABA in the brain. Moreover, AEDs can enhance the effect of GABA (e.g., benzodiazepine). However, conventional pharmacological strategies frequently fail due to the development of pharmacoresistance,

and the global manipulation of ion channels leads to widespread side effects, particularly in the cognitive domain, at higher and more effective doses. Alternative treatments include surgical resection of a seizure focus. The goal of surgical resection is to remove the seizure origin or disrupt the spread of the seizure throughout the brain. If an epileptogenic focus is found and does not reside in cortical areas responsible for speech, it may be possible to remove without compromising neurological functions. Surgery has been successful in reducing seizures and in some instances may completely alleviate the need for other treatments [9]. While AEDs and surgery have been the classical foundation of epilepsy treatment, they do not provide a satisfactory solution for many patients (see below). In contrast, dietary therapies may provide seizure control in drug-resistant forms of epilepsy [10]. The therapeutic effect of fasting on the control of seizures has been known since Hippocrates. Fasting's suppression of seizures can be mimicked by a high-fat, low-carbohydrate ketogenic diet (Fig. 2). The anticonvulsant effects brought on by metabolic changes during this diet therapy offer great promise for identifying new antiseizure targets as well as providing insight into the pathophysiology of the epileptic brain (see below).

---

## Influence of Treatment on Metabolism

The sharp decrease in carbohydrate intake during ketogenic diet treatment reduces glucose utilization as an energy source. Instead, the liver utilizes fatty acids to produce ketone bodies, mainly β-hydroxybutyrate and acetoacetate. Neurons in turn will use these ketone bodies for cellular metabolism in place of glucose (Fig. 2). Many hypotheses exist to explain the anticonvulsant action of the ketogenic diet, but despite its name, the ketone bodies themselves may not necessarily be the primary effector, and the underlying mechanisms leading to reduced seizure activity are largely unknown. Among beneficial metabolic changes induced by ketogenic diet therapy are (1) increased levels of adenosine [11], (2)

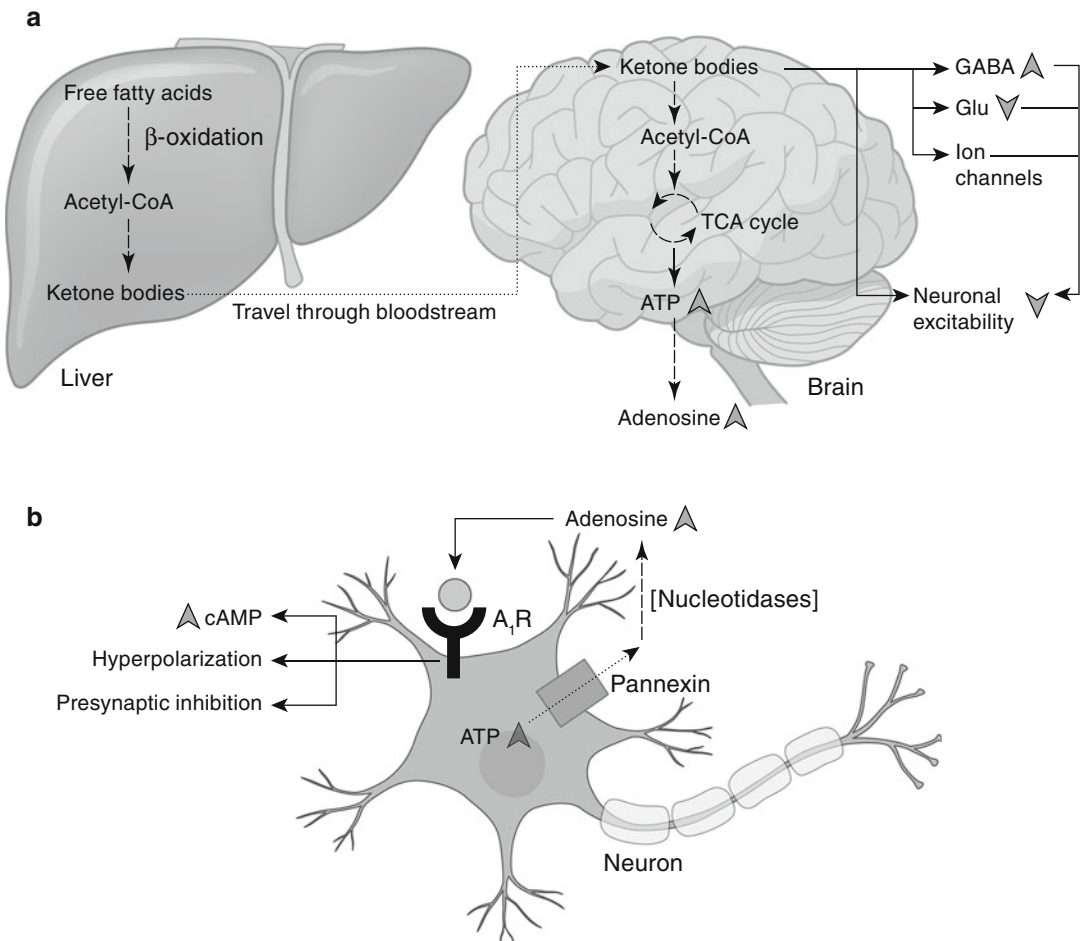

**Fig. 2** Mechanism of action for the ketogenic diet. **(a)** Schematic diagram illustrating ketone body formation from fatty acids present in the ketogenic diet and their subsequent use in the brain as fuel for ATP production. Ketogenic diet is reported to increase adenosine and  $\gamma$ -aminobutyric acid (*GABA*), to decrease glutamate (*Glu*), and to directly act on neurotransmitters subsequently

reducing neuronal excitability. **(b)** Increased intracellular ATP moves ATP along its concentration gradient through pannexin to the extracellular space. Here, it is degraded by nucleotidases to its core constituent, adenosine, which can act on inhibitory A<sub>1</sub> receptors (A<sub>1</sub>R) to cause presynaptic inhibition and hyperpolarization to prevent seizures. *cAMP* cyclic adenosine monophosphate

increased *GABA*, (3) and decreased *Glu*, which all combine with a direct action of ketone bodies on ion channels to reduce neuronal excitability [10]. Ketosis increases mitochondrial biogenesis and thereby the production of ATP, which is a direct metabolic precursor of adenosine (as it leaves the neuron via the transmembrane channel pannexin and is converted to adenosine extracellularly (Fig. 2) [12]. It is this unique metabolic modulation that builds excitement not only for a deeper understanding of the ketogenic diet but for metabolic manipulations in general as a novel

anticonvulsant strategy with good efficacy and few side effects.

## Perspectives

Inefficacy of current AED treatment in 30 % of patients signals the need for a deeper understanding of homeostatic mechanisms that govern the pathophysiology of epilepsy. Future studies should investigate the metabolic changes in epilepsy in order to establish novel treatment

approaches. Current investigations consider a variety of alternative therapeutic interventions such as focal cooling [13], cell therapy [14, 15], gene therapy [16–18], or focal adenosine augmentation [15] to harness endogenous anticonvulsant mechanisms of the brain therapeutically.

Indeed, it is time to redefine epilepsy as a complex syndrome of disrupted network homeostasis, which includes seizures not only as the major pathological trait but also a wide range of so-called comorbidities including cognitive impairment, sleep dysfunction, depression (see chapter “Major depressive disorder”), and psychiatric impairment. Conventional AEDs were solely designed to suppress seizures, which is only a symptom of epilepsy, albeit the most obvious. Based on the neurocentric rationale of drug development, it becomes clear that conventional AEDs are a poor choice to treat epilepsy as a syndrome in a “holistic” sense. Novel therapeutic avenues aimed at reconstructing the homeostasis of network regulation may ultimately provide better treatment options and hopes for finding a cure for epilepsy. In this regard, metabolic interventions and focal adenosine augmentation appear to be promising homeostatic therapies, which might be effective in pharmacoresistant epilepsy and poised to reduce the disease burden of epilepsy.

## References

- Steinhauser C, Boison D (2012) Epilepsy: crucial role for astrocytes. *Glia* 60:1191
- Boison D (2012) Adenosine dysfunction in epilepsy. *Glia* 60:1234–1243
- Newby AC, Worku Y, Holmquist CA (1985) Adenosine formation. Evidence for a direct biochemical link with energy metabolism. *Adv Myocardiol* 6:273–284
- Fredholm BB (2007) Adenosine, an endogenous distress signal, modulates tissue damage and repair. *Cell Death Differ* 14:1315–1323
- Boison D (2005) Adenosine and epilepsy: from therapeutic rationale to new therapeutic strategies. *Neuroscientist* 11:25–36
- Dragunow M (1991) Adenosine and seizure termination. *Ann Neurol* 29:575
- Kwan P, Brodie MJ (2000) Early identification of refractory epilepsy. *N Engl J Med* 342:314–319
- Loscher W, Schmidt D (2011) Modern antiepileptic drug development has failed to deliver: ways out of the current dilemma. *Epilepsia* 52:657–678
- de Tisi J, Bell GS, Peacock JL, McEvoy AW, Harkness WF, Sander JW, Duncan JS (2011) The long-term outcome of adult epilepsy surgery, patterns of seizure remission, and relapse: a cohort study. *Lancet* 378:1388–1395
- Lutas A, Yellen G (2013) The ketogenic diet: metabolic influences on brain excitability and epilepsy. *Trends Neurosci* 36:32–40
- Masino SA, Li T, Theofilas P, Sandau US, Ruskin DN, Fredholm BB, Geiger JD, Aronica E, Boison D (2011) A ketogenic diet suppresses seizures in mice through adenosine A1 receptors. *J Clin Invest* 121:2679–2683
- Masino SA, Geiger JD (2008) Are purines mediators of the anticonvulsant/neuroprotective effects of ketogenic diets? *Trends Neurosci* 31:273–278
- Rothman SM (2009) The therapeutic potential of focal cooling for neocortical epilepsy. *Neurotherapeutics* 6:251–257
- Thompson KW (2005) Genetically engineered cells with regulatable GABA production can affect after discharges and behavioral seizures after transplantation into the dentate gyrus. *Neuroscience* 133:1029–1037
- Boison D (2009) Adenosine augmentation therapies (AATs) for epilepsy: prospect of cell and gene therapies. *Epilepsy Res* 85:131–141
- Noe F, Nissinen J, Pitkanen A, Gobbi M, Sperk G, During M, Vezzani A (2007) Gene therapy in epilepsy: the focus on NPY. *Peptides* 28:377–383
- McCown TJ (2009) Adeno-associated virus vector-mediated expression and constitutive secretion of galanin suppresses limbic seizure activity. *Neurotherapeutics* 6:307–311
- Raol YH, Lund IV, Bandyopadhyay S, Zhang G, Roberts DS, Wolfe JH, Russek SJ, Brooks-Kayal AR (2006) Enhancing GABA(A) receptor alpha 1 subunit levels in hippocampal dentate gyrus inhibits epilepsy development in an animal model of temporal lobe epilepsy. *J Neurosci* 26:11342–11346

---

# Parkinson's Disease

Giulia Ambrosi, Silvia Cerri, and Fabio Blandini

---

## Introduction to Parkinson's Disease

Parkinson's disease (PD), the second most common neurodegenerative disease after Alzheimer's disease, affects approximately 1 % of the population over 65 years of age. PD is primarily a sporadic disease and aging is the principal risk factor. Sporadic PD is a complex multifactorial disorder with variable contribution of genetic susceptibility and environmental factors. Several mechanisms are involved in the disease pathogenesis, such as mitochondrial dysfunctions, oxidative damage, autophagic alterations, proteasome impairment and protein aggregation [1]. There are also familial forms of PD, accounting for 5–10 % of all cases, associated with mutations in PARK genes. Interestingly, PARK genes encode for proteins involved in the maintenance of protein homeostasis, mitochondrial integrity and release of neurotransmitter-containing vesicles [2]. One of the major pathological hallmarks of PD is the accumulation of  $\alpha$ -synuclein-containing

aggregates (Lewy bodies) in neuronal perikarya and processes as a consequence of the proteolytic deficit, typical of the pathology.

On the clinical side, cardinal signs of PD include resting tremor, bradykinesia (slowness of movement), rigidity and postural instability (loss of upright stability). These motor dysfunctions are attributable to the progressive loss of dopaminergic cells within the substantia nigra pars compacta (SNc) and become overt when approximately 80 % of striatal dopamine (DA) and 50 % of nigral neurons are lost [3]. In fact, the SNc sends dopaminergic projections to the corpus striatum, and both the SNc and the striatum contribute to the basal ganglia circuitry, a system of nuclei involved in the modulation of voluntary movement. In addition, various non-motor symptoms may develop, such as autonomic dysfunctions, sleep disturbances, depression (see chapter “[Major depressive disorder](#)”) and cognitive impairment, indicating that the neurodegenerative process is not limited to dopaminergic cells but involves other neurotransmitter systems. Non-motor symptoms often precede the onset of classical motor manifestations and contribute considerably to lower quality of life [4].

---

The authors Giulia Ambrosi and Silvia Cerri contributed equally.

G. Ambrosi • S. Cerri • F. Blandini (✉)  
Laboratory of Functional Neurochemistry,  
Center for Research in Neurodegenerative Diseases,  
IRCCS “C. Mondino” National Institute of  
Neurology Foundation, Via Mondino 2,  
27100 Pavia, Italy  
e-mail: [guliambrosi@iscali.it](mailto:guliambrosi@iscali.it);  
[silvia.cerri@mondino.it](mailto:silvia.cerri@mondino.it); [fabio.blandini@mondino.it](mailto:fabio.blandini@mondino.it)

---

## Pathophysiology of Parkinson's Disease and Metabolic Alterations

Metabolic changes associated with PD have been evaluated in the brain as well as in peripheral fluids such as blood, and may reflect alterations

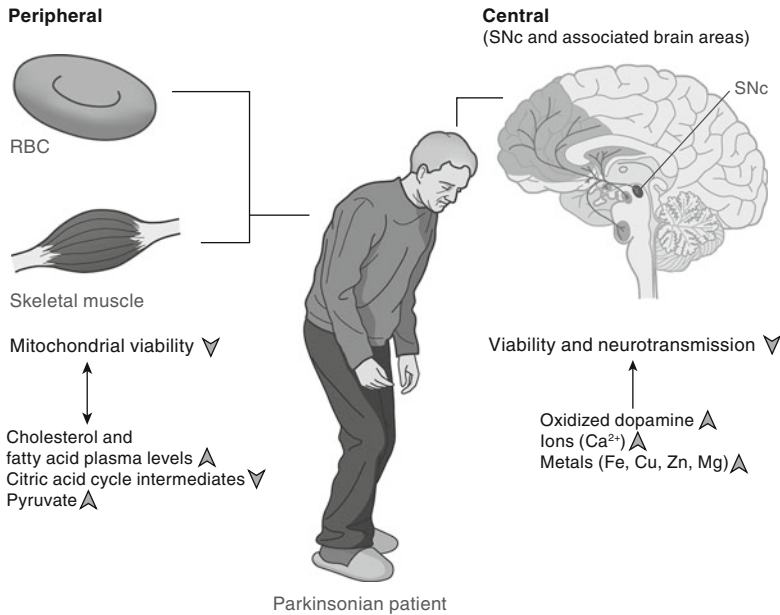

**Fig. 1** Metabolic changes in Parkinson's disease. Metabolic changes in Parkinson's disease include central (*right side*) and peripheral (*left side*) alterations. Metabolic changes in the brain affect the substantia nigra pars compacta (*SNc*) and (non)-dopaminergic associated areas. Increased levels of Ca<sup>2+</sup>, oxidized dopamine, and other metals ions such as iron induce neuronal death and alter

neurotransmission. Mitochondrial viability and integrity are also strongly affected, both in the brain and in peripheral cells such as lymphocytes, platelets, red blood cells (*RBCs*) and skeletal muscle cells. Changes in lipid content and metabolism, together with energetic imbalances, can also be found in the blood plasma

occurring at central level and/or represent biomarkers of ongoing pathology.

Selective vulnerability of dopaminergic neurons likely involves DA oxidation and Ca<sup>2+</sup> homeostasis, which are both elevated in the SNc of animal models of PD and patients [5]. In a rodent model of PD, ions such as iron, manganese, copper and zinc are increased in the brain regions associated with the dopaminergic pathway [6]. Changes in the striatal levels of excitatory (glutamate) and inhibitory ( $\gamma$ -aminobutyric acid or GABA) neurotransmitters were found in another rodent model of PD indicating imbalanced neurotransmission in PD basal ganglia [7].

Epidemiologic data show that low levels of circulating fatty acids and cholesterol increase the risk of developing PD, suggesting that also lipid metabolism is affected [8]. The involvement of mitochondrial dysfunctions in the etiopathogenesis of PD suggests the existence of defects in energy metabolism. Reduced complex I activity was observed in mitochondria from SNc, platelets,

lymphocytes, and skeletal muscle in PD patients [9]. Concerning metabolic intermediates, increased pyruvate concentrations, as well as decreased levels of citrate, acetate, succinate, and malate – intermediates of the citric acid cycle (also called tricarboxylic acid cycle) – were detected in the plasma of naïve PD patients [10]. All these conditions ultimately favor neurodegeneration, suggesting that changes in energy metabolism contribute to PD (Fig. 1).

## Treatment of Parkinson's Disease

The pharmacological treatment currently available for PD is purely symptomatic and is based on the restoration of DA levels in the brain. The typical treatment consists in the administration of L-3,4-hydroxyphenylalanine (L-dopa), which crosses the blood-brain barrier (unlike DA itself) and is directly converted into DA by the aromatic L-amino acid decarboxylase. In everyday



PD therapy, L-dopa is administered in combination with decarboxylase inhibitors (benserazide or carbidopa), which prevent its peripheral transformation into DA, thereby increasing the drug's availability in the brain. L-dopa significantly ameliorates PD motor deficits. However, chronic treatment is frequently associated with progressive reduction of drug's efficacy and the development of complications such as involuntary movements known as L-dopa-induced dyskinesia (LIDs). LIDs are the result of pre- and postsynaptic changes induced by chronic and pulsatile stimulation of striatal dopaminergic receptors [11]. Therefore, complementary drugs are given in order to counteract side effects or improve efficacy. One class of drugs is based on DA agonists, which activate DA receptors by mimicking the endogenous neurotransmitter. They can be divided into two groups: the ergot (cabergoline, bromocriptine) and the non-ergot (rotigotine, pramipexole) derivatives. The two groups are different not only in terms of structure but also for their spectrum of activity, with the non-ergot derivatives being more selective on dopaminergic D2/D3 receptors and the ergot acting also on non-dopaminergic targets, thereby inducing more side effects. They can be used as adjunctive therapy or as monotherapy, before L-dopa or after motor complications have appeared. DA agonists are less efficacious than L-dopa in treating motor symptoms of PD and are associated with the development of psychiatric side effects and impulse control disorder [12].

Monoamine oxidase-B (MAO-B) inhibitors (selegiline, rasagiline) block the oxidation of DA by MAO-B, which is part of the physiological inactivation of DA in the brain, thus increasing DA levels at the synapse. MAO-B inhibitors have a modest effect and are used as monotherapy at early stages or as adjuncts to L-dopa for reducing motor fluctuations [13]. Further interest was dedicated to MAO-B inhibitors, in particular rasagiline, because of their neuroprotective properties and therefore their ability to slow PD progression [14].

Non-dopaminergic drugs, such as anticholinergics and amantadine, may also be adopted. In early phases of PD, anticholinergic drugs

(trihexyphenidyl, benztropine) may improve tremor by antagonizing muscarinic acetylcholine receptors on striatal interneurons. Their use is restricted to short periods because of the side effects observed both at central (cognitive decline) and peripheral (tachycardia, meaning increased heart rate, and constipation) level. Amantadine, an antagonist of the N-methyl-D-aspartate (NMDA) receptor (an ionotropic glutamate receptor), has shown antidyskinetic effects in advanced PD patients under L-dopa treatment [15] acting on central glutamatergic neurons.

Over the past decades, neurosurgical interventions have also been performed in PD patients. Deep brain stimulation (DBS), based on the implant of electrodes mainly in the subthalamic nucleus of PD patients, is the most common surgical therapy. PD patients with intractable tremor and major side effects due to chronic L-dopa, but free from dementia and psychiatric comorbidities, are typical candidates for DBS [16].

---

### **Influence of Treatment on Metabolism and Consequences for Patients**

Only few studies have investigated changes in metabolism due to antiparkinsonian treatment. Altered levels of methylation products, such as increased concentrations of homocysteine, were found in plasma from PD patients under L-dopa medication as a consequence of the catabolism of this molecule (to 3-O-methyldopa) [17].

Many studies have found that PD patients undergoing treatment show increased body weight. DBS is accompanied by weight gain in the first postoperation months. Reasons might include lower energy expenditure, fewer motor complications and altered eating behavior [18], and might involve DBS-induced modulation of hypothalamic areas, essential in maintaining homeostatic control of bodily functions such as feeding and sleeping [19]. Compulsive eating and weight gain are also observed after treatment with DA agonists such as pramipexole. These disturbances have been attributed to excessive

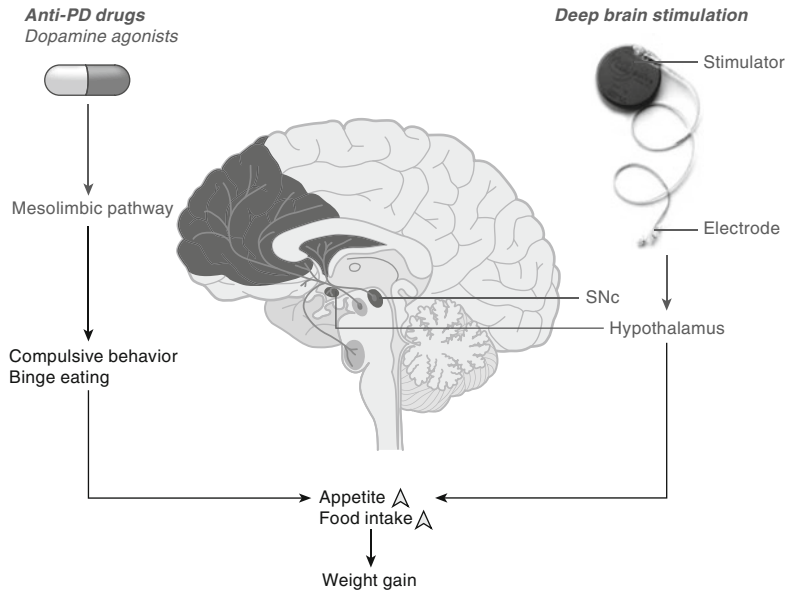

**Fig. 2** Influence of Parkinson's disease treatment on metabolism. Metabolic changes after antiparkinsonian therapy and surgical interventions are due to secondary effects on the intact mesolimbic pathway parallel to the affected nigrostriatal system and on the hypothalamus. Dopamine-based medication (*left side*) hyperactivates the mesolimbic pathway, associated with the brain nuclei dedicated to the perception of reward, thereby causing

compulsive behavior and binge eating. Deep brain stimulation (*right side*) affects mostly the hypothalamus, a brain nucleus dedicated to control of homeostatic behaviors such as eating and sleeping. In both cases, the effects are increased appetite and food intake leading to weight gain and therefore complications of the clinical spectrum. SNc substantia nigra pars compacta, PD Parkinson's disease

activation of the mesolimbic pathway, connecting the dopaminergic ventral tegmental area with limbic structures such as the nucleus accumbens and the amygdala. This pathway has been linked to the biological perception of reward and the activation of responses associated with it; therefore, PD therapy causes compulsive behaviors and binge eating through the hyperactivation of this system [20]. Finally, weight gain in PD patients increases the risk for other metabolic disturbances, such as diabetes (see chapter “[Diabetes mellitus](#)”) and cardiovascular diseases (see chapter “[Atherosclerotic heart disease](#)”), thereby adding further levels of complexity to the clinical phenotype (Fig. 2).

## Perspectives

Identification of metabolic changes in the brain or peripheral fluids is essential to develop biomarkers and to unravel the mechanisms that

underlie PD pathogenesis, since metabolites act as indicators of cellular physiology and homeostasis. Indeed, the identification of biomarkers to diagnose and monitor the progression of the disease is currently one of the most intriguing and challenging areas of PD research. The evaluation of metabolomic profiles is a promising tool for supporting the diagnosis of PD, possibly in the very early phases of the disease [10], and might also be useful to identify prognostic markers, as well as to anticipate the response to pharmacological treatment. These studies will eventually lead to a better description of PD molecular and clinical phenotypes and therefore optimization of therapeutic intervention. New possible pharmacological strategies to improve both neuroprotection and motor dysfunction are in development. Thus far, encouraging results have been obtained by adopting antagonists of adenosine and glutamate receptors [11] and compounds that increase the endogenous levels of antioxidants [21].



## References

1. Greenamyre JT, Hastings TG (2004) Parkinson's-divergent causes, convergent mechanisms. *Science* 304:1120–1122
2. Belin AC, Westerlund M (2008) Parkinson's disease: a genetic perspective. *FEBS J* 275:1377–1383
3. Schulte C, Gasser T (2011) Genetic basis of Parkinson's disease: inheritance, penetrance, and expression. *Appl Clin Genet* 4:67–80
4. Olanow CW, Obeso JA (2012) The significance of defining preclinical or prodromal Parkinson's disease. *Mov Disord* 27:666–669
5. Surmeier DJ, Guzman JN, Sanchez-Padilla J, Schumacker PT (2011) The role of calcium and mitochondrial oxidant stress in the loss of substantia nigra pars compacta dopaminergic neurons in Parkinson's disease. *Neuroscience* 198:221–231
6. Tarohda T, Ishida Y, Kawai K, Yamamoto M, Amano R (2005) Regional distributions of manganese, iron, copper, and zinc in the brains of 6-hydroxydopamine-induced parkinsonian rats. *Anal Bioanal Chem* 383:224–234
7. Gao HC, Zhu H, Song CY, Lin L, Xiang Y, Yan ZH, Bai GH, Ye FQ, Li XK (2013) Metabolic changes detected by ex vivo high resolution <sup>1</sup>H NMR spectroscopy in the striatum of 6-OHDA-induced Parkinson's rat. *Mol Neurobiol* 47:123–130
8. de Lau LM, Koudstaal PJ, Hofman A, Breteler MM (2006) Serum cholesterol levels and the risk of Parkinson's disease. *Am J Epidemiol* 164:998–1002
9. Esteves AR, Arduíno DM, Silva DF, Oliveira CR, Cardoso SM (2011) Mitochondrial dysfunction: the road to alpha-synuclein oligomerization in PD. *Parkinsons Dis* 2011:693761
10. Ahmed SS, Ahmed SS, Santosh W, Kumar S, Christlet HT (2009) Metabolic profiling of Parkinson's disease: evidence of biomarker from gene expression analysis and rapid neural network detection. *J Biomed Sci* 16:63
11. Blandini F, Armentero MT (2012) New pharmacological avenues for the treatment of L-DOPA-induced dyskinesias in Parkinson's disease: targeting glutamate and adenosine receptors. *Expert Opin Investig Drugs* 21:153–168
12. Antonini A, Tolosa E, Mizuno Y, Yamamoto M, Poewe WH (2009) A reassessment of risks and benefits of dopamine agonists in Parkinson's disease. *Lancet Neurol* 8:929–937
13. Yuan H, Zhang ZW, Liang LW, Shen Q, Wang XD, Ren SM, Ma HJ, Jiao SJ, Liu P (2010) Treatment strategies for Parkinson's disease. *Neurosci Bull* 26:66–76
14. Schapira AH (2011) Monoamine oxidase B inhibitors for the treatment of Parkinson's disease: a review of symptomatic and potential disease-modifying effects. *CNS Drugs* 25:1061–1071
15. Lugging E, Wenning GK, Bösch S, Poewe W (2000) Beneficial effects of amantadine on L-dopa-induced dyskinesias in Parkinson's disease. *Mov Disord* 15:873–878
16. Smith Y, Wichmann T, Factor SA, DeLong MR (2012) Parkinson's disease therapeutics: new developments and challenges since the introduction of levodopa. *Neuropsychopharmacology* 37: 213–246
17. Blandini F, Fancellu R, Martignoni E, Mangiagalli A, Pacchetti C, Samuele A, Nappi G (2001) Plasma homocysteine and L-DOPA metabolism in patients with Parkinson disease. *Clin Chem* 47:1102–1104
18. Rieu I, Derost P, Ulla M, Marques A, Debilly B, De Chazeron I, Chéreau I, Lemaire JJ, Boirie Y, Llorca PM, Durif F (2011) Body weight gain and deep brain stimulation. *J Neurol Sci* 310:267–270
19. Guimarães J, Moura E, Vieira-Coelho MA, Garrett C (2012) Weight variation before and after surgery in Parkinson's disease: a noradrenergic modulation? *Mov Disord* 27:1078–1082
20. Nirenberg MJ, Waters C (2006) Compulsive eating and weight gain related to dopamine agonist use. *Mov Disord* 21:524–529
21. Hwang O (2013) Role of oxidative stress in Parkinson's disease. *Exp Neurobiol* 22:11–17

---

# Alzheimer's Disease

Milos D. Ikonomic and Steven T. DeKosky

---

## Introduction to Alzheimer's Disease

Alzheimer's disease (AD) is a chronic neurodegenerative disorder and the leading cause of dementia in the elderly. It is predicted that by 2050 over 13 million people in the United States will have AD dementia [1]. AD has an immense socioeconomic impact on patients, families, and caregivers and is a huge burden to the health-care system as the cost of care for AD and other dementias is expected to increase from an estimated \$203 billion in 2013 to a projected \$1.2 trillion per year by 2050 [2]. Clinical onset of AD is characterized by initial symptoms of short-term memory loss, which worsens gradually and is accompanied by language disturbances, apathy, and impairments in executive function and daily functioning. Neuropsychiatric symptoms (e.g., depression, anxiety, hallucinations) are frequent in mid- to late stages.

There is still controversy regarding the cause of the disease. Dr. Alois Alzheimer, who

published the first clinicopathological report of the disease in 1906 [3], observed the two major histopathological hallmarks of AD, "senile" plaques (also called amyloid plaques) and neurofibrillary tangles [4], composed primarily of the amyloid- $\beta$  peptide and over-phosphorylated tau protein, respectively. Pathological aggregates of other proteins (e.g., ubiquitin and  $\alpha$ -synuclein) are also commonly found in AD as well as other proteinopathies such as Parkinson's disease (see chapter "Parkinson's disease") [5]. As the disease progresses, there is loss of synapses and neurons [6]. These structural losses, which correlate with cognitive decline [7], are accompanied by atrophy in the medial temporal lobe and eventually severe diffuse brain atrophy more marked in the association cortices.

At present, brain biopsy or postmortem examination of the brain is the only definitive method of diagnosing AD. However, clinical diagnosis is increasingly accurate, using biomarkers in the cerebrospinal fluid and imaging of amyloid plaques with positron emission tomography (PET). Additionally, longitudinal computer tomography (CT) and now magnetic resonance imaging (MRI) yield a clearer understanding of the rate of volume loss and correlation with cognitive decline (Fig. 1) [8].

The most powerful risk factor for AD is advanced age. Epidemiological studies suggest that the prevalence of AD doubles every 5 years after age 65 and approaches 50 % by age 90. Other risk factors include cardiovascular and metabolic diseases and related conditions, such

---

M.D. Ikonomic  
Departments of Neurology and Psychiatry,  
University of Pittsburgh School of Medicine and  
Geriatric Research Education and Clinical Center,  
VA Pittsburgh Healthcare System,  
200 Lothrop Street, BSTWR-S521,  
Pittsburgh, PA 15213, USA  
e-mail: [ikonomicmd@upmc.edu](mailto:ikonomicmd@upmc.edu)

S.T. DeKosky (✉)  
Department of Neurology,  
University of Virginia School of Medicine,  
800793, Charlottesville, VA 22908, USA  
e-mail: [dekosky@virginia.edu](mailto:dekosky@virginia.edu)

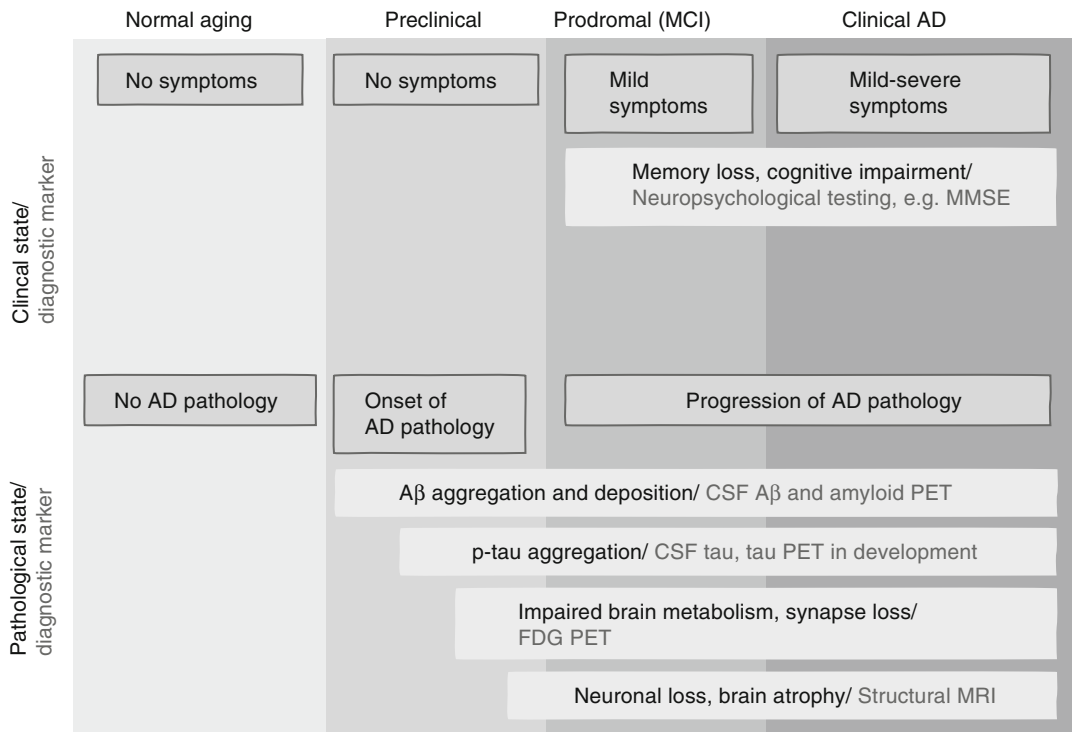

**Fig. 1** Clinical and neuropathological continuum of mild cognitive impairment (*MCI*) and Alzheimer's disease (*AD*). *AD* pathology is initiated over a decade prior to symptoms. The earliest detectable pathological changes are amyloid- $\beta$  (*A $\beta$* ) plaque deposits in the brain parenchyma, detectable using amyloid positron emission tomography (*PET*) imaging, and decreased *A $\beta$*  concentration in the cerebrospinal fluid (*CSF*), as *A $\beta$*  is retained in the brain rather than cleared to the *CSF*. The latter is detectable using enzyme-linked immunosorbent assay

as hypertension (see chapter “[Hypertension](#)”), hyperlipidemia (see chapter “[Hyperlipidemia](#)”), obesity, diabetes (see chapter “[Diabetes mellitus](#)”), and metabolic syndrome (see chapter “[Metabolic syndrome](#)”); brain injury, such as traumatic brain injury, stroke (see chapter “[Stroke](#)”), and microhemorrhages; substance abuse, e.g., smoking and alcohol abuse; and depression (see chapter “[Major depressive disorder](#)”).

Based on genetic risk factors, *AD* can be divided into autosomal dominant familial *AD* (*FAD*) and nondominant forms, which are most commonly those of late life onset [9]. *FAD* forms are caused by mutations in several genes essential for metabolism of the amyloid precursor protein (*APP*, see below). Transgenic mice expressing these gene mutations are common animal models to study *AD*. *FADs* show earlier onset (usually between

(*ELISA*). *A $\beta$*  aggregation precedes p-tau aggregation. Impairment of neuronal metabolism and loss of synaptic structure and function may begin in the preclinical stage and are detectable using fluorodeoxyglucose (*FDG*)-*PET*. Finally, neuronal loss and resulting brain atrophy occur, detectable with structural magnetic resonance imaging (*MRI*). Once initiated, these pathologies proceed to advance progressively and are believed to contribute to clinical symptoms. *MMSE* mini-mental state examination

ages 35 and 50), yet they are responsible for less than 1 % of all *AD* cases. In contrast, nondominant forms of *AD* are seen in over 99 % of cases and are characterized by late onset (usually over age 65) and slow clinical progression. There is a clear genetic association with subjects' inheritance of an apolipoprotein E4 allele (*ApoE4*, see below).

## Pathophysiology of Alzheimer's Disease and Metabolic Alterations

Amyloid pathology is detectable in the preclinical phase of *AD*, prior to changes in any other biomarkers and sometimes a decade or more before the earliest changes in an individual's cognition (Fig. 1) [10, 11]. This is in agreement with the “amyloid cascade” hypothesis of *AD*, in which

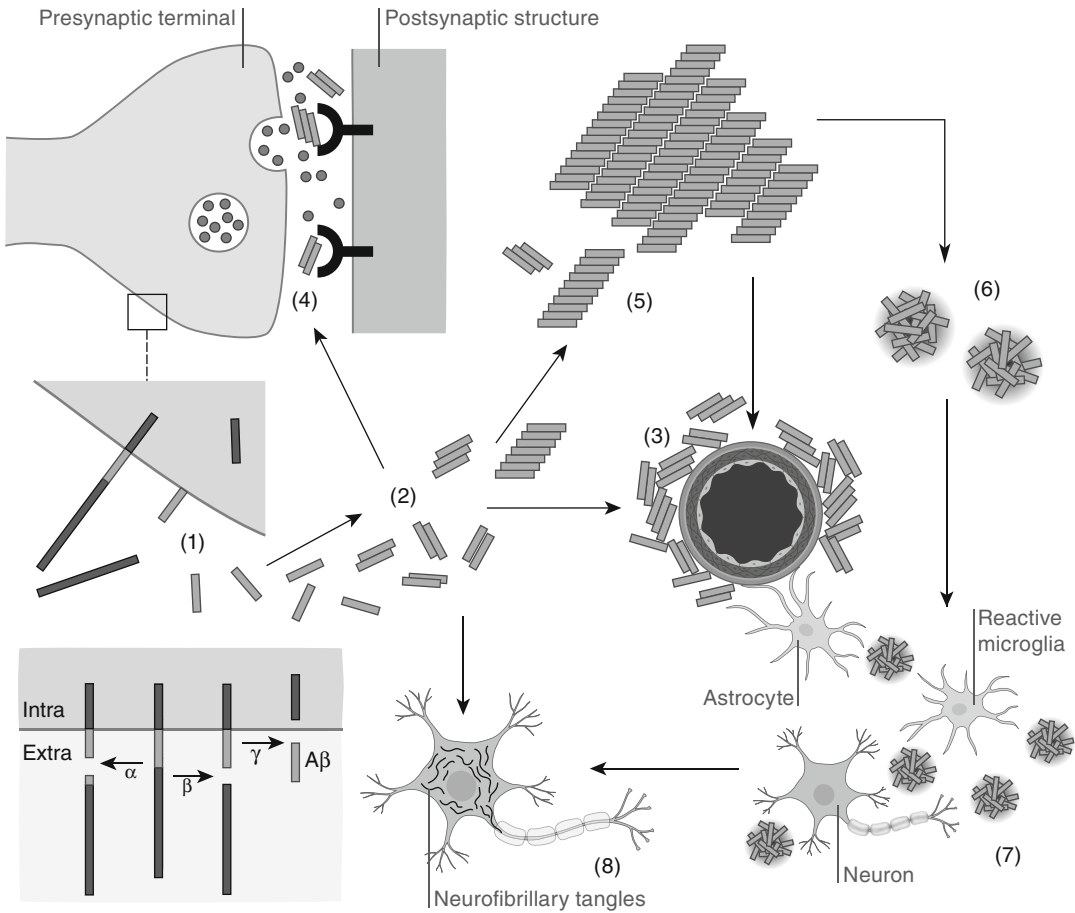

**Fig. 2** Generation of Aβ and the pathological cascade in Alzheimer's disease. The amyloid precursor protein APP is metabolized (1) physiologically mainly by α-secretase (left arrow), preventing excessive formation of the Aβ peptide. β- and γ-secretase (right arrow) cleave APP to release soluble Aβ. Aβ monomers assemble into soluble Aβ oligomers (2). Aβ oligomers can be cleared via the brain vasculature, but in advanced disease stages, Aβ fibrils can deposit in cerebral blood vessels walls (3). Soluble Aβ oligomers are believed to interfere with synaptic function and cause memory impairment (4). Further,

the oligomers form Aβ fibrils that comprise the dense β-pleated sheet of amyloid in plaques (5). Typical amyloid plaques in the brain parenchyma consist of fibrillar Aβ deposits (6) and apolipoproteins. In advanced stages, they are surrounded by dystrophic neuronal processes and are called neuritic plaques. Amyloid plaques probably initiate an inflammatory process that involves reactive microglia and astrocytes (7). Finally, Aβ is believed to contribute to the development of neurofibrillary tangles (8) and neuronal cell death

altered metabolism of APP results in accumulation of Aβ peptides in extracellular fibrillar aggregates (amyloid plaques) or diffusible oligomeric forms, driving AD pathogenesis [12]. Additionally, neurofibrillary tangles consisting of intracellular fibrillar bundles of the microtubule-associated protein tau, which has been highly phosphorylated and cross-linked and thus rendered nonfunctional, are commonly observed in AD.

APP is a putative transmembrane protein, with a short intracellular C-terminus and a long extracellular N-terminus. While much is now known

about APP metabolism, its primary function is unclear [13]. Under physiological conditions, the predominant APP metabolic pathway involves the enzyme α-secretase, which cuts the APP within the Aβ peptide sequence, thus preventing its genesis (Fig. 2). An alternative metabolic pathway (the amyloidogenic pathway) produces Aβ peptide via proteolytic actions of the enzymes β- and γ-secretase (Fig. 2).

The Aβ sequence spans 40–43 amino acids from an N-terminal location (the β-secretase cut site) to an intramembranous location (the

$\gamma$ -secretase cut site). The intramembranous  $\gamma$ -secretase is a complex of four proteins. One of them (presenilin 1) is the target of the most frequent gene mutation causing FAD [14].

A $\beta$  is found in many heterogeneous forms, including truncations and modifications at C- and N-terminus. Once released from APP, A $\beta$  monomers self-assemble into diffusible oligomers (Fig. 2), which further assemble into protofibrils and insoluble fibrils that clump together and form amyloid plaque deposits in brain parenchyma, as well as in cerebral blood vessel walls (causing cerebral amyloid angiopathy, CAA). Amyloid fibrils (and their characteristic  $\beta$ -sheet structure) can be detected using Congo red histochemistry postmortem or PET imaging in living patients. PET utilizes the differential uptake of amyloid-binding PET radioligands (e.g.,  $^{11}\text{C}$ -Pittsburgh compound B,  $^{18}\text{F}$ -florbetapir,  $^{18}\text{F}$ -florbetaben,  $^{18}\text{F}$ -flutemetamol), all of which bind transiently to A $\beta$  fibrils, enabling differential focal positron emission and generating elevated signal in the region of plaque deposition and/or CAA in the brain.

A $\beta$  plaques are morphologically heterogeneous and in advanced stages contain a dense amyloid core surrounded by dystrophic neurites (i.e., “neuritic” plaques), the latter associated with inflammatory reactions in AD brain (Fig. 2). Diffusible (non-fibrillar) A $\beta$  oligomers cause synapse dysfunction (Fig. 2), contributing to cognitive impairment [12].

The relationship between amyloid pathology and the development of phosphorylated tau (p-tau), which leads to neurofibrillary tangles, is an important question that is not understood fully. A $\beta$  and p-tau fibrils might propagate AD lesions via a common mechanism, allowing the spread of A $\beta$ , tau, and other misfolded fibrillar proteins among interconnected brain areas [15–18].

The accumulation of A $\beta$  in the brain might be due to increased production or decreased clearance or both. Progressive slowing of A $\beta$  clearance in aging may lead to increased concentrations in the brain and reduced concentrations in cerebrospinal fluid. ApoE is the lipoprotein carrier that docks with low-density lipoprotein (LDL) receptor-related protein 1 and removes A $\beta$  from the central nervous system, and the E4 allele produces

an apolipoprotein that is not as efficient at such removal, providing a rationale for why it is associated with greater risk of AD and adding support to the hypothesis that the buildup of amyloid plaques in the brain is due to decreased removal of A $\beta$  over the lifespan (rather than increased production).

---

## Implications for Treatment and Influence of Treatment on Metabolism

Medications for AD can be grouped into three categories: (1) symptomatic medications, such as efforts to boost neurotransmitter signaling in affected systems or preventing excitotoxicity; (2) medications directed at nonspecific pathological processes in AD, e.g., antioxidants or anti-inflammatory medications; and (3) medications directed at specific AD pathologies, e.g., against A $\beta$  or against pathological transformation of tau. There are no approved and effective disease-modifying treatments, although a number of studies are underway.

As reduced acetylcholine transmission and metabolism is a well-known feature of AD, acetylcholinesterase inhibitors (e.g., donepezil, rivastigmine, galantamine) are the most common symptomatic treatment. They act by preventing the degradation of acetylcholine, thereby prolonging its action at the synapses and improving cholinergic neurotransmission. Most common side effects include nausea and vomiting, due to excessive cholinergic signaling.

Memantine, a noncompetitive antagonist of N-methyl-D-aspartate (NMDA) receptors, has also been shown to correct neurochemical abnormalities, such as excitotoxicity. Side effects are rare but include headache, dizziness, and hallucinations.

Despite high hopes and suggestions of risk reduction seen in epidemiological studies, antioxidants, anti-inflammatories, and endocrine agents have been unsuccessful in showing positive effects in clinical trials in mild to moderate AD. Decreases in amyloid plaques (based on PET imaging) have been reported in anti-amyloid

therapies [19]. However, even with the effects of reducing plaque, the anti-amyloid interventions have thus far been unsuccessful in improving clinical outcomes. Thus, increased attention is being directed at intervention in earlier disease stages, including mild cognitive impairment, a prodromal stage of the disease, in which abnormal cognitive function (usually short-term memory) does not yet meet the clinical criteria for AD dementia (Fig. 2) [20].

## Perspectives

New analyses of biological fluids and imaging biomarkers in younger people with known mutations indicate that pathology is present more than a decade prior to development of the earliest symptoms [11]. Thus, therapies will continue to be directed toward people in all phases of the disease, with increasing emphasis on the earliest clinical manifestations and on preclinical detection and intervention. Prevention trials, while expensive and of long duration, are necessary to prevent or delay the disease from emerging [21, 22].

Development of medications for people in later stages will continue and must be accompanied by a search for medications that better treat neuropsychiatric symptoms. Currently approved medications, the cholinesterase inhibitors and memantine, have mild effects and do not effectively slow disease progression. Like other complex diseases, e.g., cancer or heart disease, more than one therapy will likely be necessary to treat the symptoms or slow disease progression. More effective behavioral interventions to maintain the dignity and safety of people with dementia will also be necessary. The recognition that minimizing barriers and allowing patients in chronic care facilities to use wandering paths and safe environments has decreased the use of physical and “chemical” restraints and improved quality of life for people with moderate to severe AD.

In sum, the onset and course of AD likely is influenced by a combined effect of multiple demographic and genetic risk factors, and thus genetics of AD continues to be a major area of research [23].

## References

1. Hebert LE, Weuve J, Scherr PA, Evans DA (2013) Alzheimer disease in the United States (2010–2050) estimated using the 2010 census. *Neurology* 80: 1778–1783
2. Alzheimer's Association's (2013) Alzheimer's disease facts and figures report. [www.alz.org/downloads/facts\\_figures\\_2013.pdf](http://www.alz.org/downloads/facts_figures_2013.pdf). As available on 18 Aug 2013
3. Alzheimer A (1907) Über eine eigenartige Erkrankung der Hirnrinde. *Allgemeine Zeitschrift für Psychiatrie und Psychisch-Gerichtliche Medizin* 64:146–148
4. Maurer K, Volk S, Gerbaldo H (1997) Auguste D and Alzheimer's disease. *Lancet* 349:1546–1549
5. Jellinger KA (2008) Neuropathological aspects of Alzheimer disease, Parkinson disease and frontotemporal dementia. *Neurodegener Dis* 5(3–4):118–121
6. Arendt T (2009) Synaptic degeneration in Alzheimer's disease. *Acta Neuropathol* 118:167–179
7. DeKosky ST, Harbaugh RE, Schmitt FA, Bakay RA, Chui HC, Knopman DS, Reeder TM, Shetter AG, Senter HJ, Markesbery WR (1992) Cortical biopsy in Alzheimer's disease: diagnostic accuracy and neurochemical, neuropathological and cognitive correlations. *Ann Neurol* 32:625–632
8. Leung KK, Bartlett JW, Barnes J, Manning EN, Ourselin S, Fox NC (2013) Cerebral atrophy in mild cognitive impairment and Alzheimer disease: rates and acceleration. *Neurology* 80:648–654
9. Tanzi RE (2012) The genetics of Alzheimer disease. *Cold Spring Harb Perspect Med* 2. pii:a006296
10. Jack CRJ, Knopman DS, Jagust WJ, Petersen RC, Weiner MW, Aisen PS, Shaw LM, Vemuri P, Wiste HJ, Weigand SD, Lesnick TG, Pankratz VS, Donohue MC, Trojanowski JQ (2013) Tracking pathophysiological processes in Alzheimer's disease: an updated hypothetical model of dynamic biomarkers. *Lancet Neurol* 12:207–216
11. Reiman EM, Quiroz YT, Fleisher AS, Chen K, Velez-Pardo C, Jimenez-Del-Rio M, Fagan AM, Shah AR, Alvarez S, Arbelaez A, Giraldo M, Acosta-Baena N, Sperling RA, Dickerson B, Stern CE, Tirado V, Munoz C, Reiman RA, Huentelman MJ, Alexander GE, Langbaum JB, Kosik KS, Tariot PN, Lopera F (2012) Brain imaging and fluid biomarker analysis in young adults at genetic risk for autosomal dominant Alzheimer's disease in the presenilin 1 E280A kindred: a case-control study. *Lancet Neurol* 11: 1048–1056
12. Hardy JA, Higgins GA (1992) Alzheimer's disease: the amyloid cascade hypothesis. *Science* 256: 184–185
13. Thinakaran G, Koo EH (2008) Amyloid precursor protein trafficking, processing, and function. *J Biol Chem* 283:29615–29619
14. Steiner H, Capell A, Leimer U, Haass C (1999) Genes and mechanisms involved in beta-amyloid generation and Alzheimer's disease. *Eur Arch Psychiatry Clin Neurosci* 249:266–270

15. Braak H, Del Tredici K (2011) Alzheimer's pathogenesis: is there neuron-to-neuron propagation? *Acta Neuropathol* 121:589–595
16. de Calignon A, Polydoro M, Suárez-Calvet M, William C, Adamowicz DH, Kopeikina KJ, Pitstick R, Sahara N, Ashe KH, Carlson GA, Spire-Jones TL, Hyman BT (2012) Propagation of tau pathology in a model of early Alzheimer's disease. *Neuron* 73:685–697
17. Liu L, Drouet V, Wu JW, Witter MP, Small SA, Clelland C, Duff K (2012) Trans-synaptic spread of tau pathology in vivo. *PLoS One* 7:e31302
18. Iba M, Guo JL, McBride JD, Zhang B, Trojanowski JQ, Lee VM (2013) Synthetic tau fibrils mediate transmission of neurofibrillary tangles in a transgenic mouse model of Alzheimer's-like tauopathy. *J Neurosci* 33:1024–1037
19. Rinne JO, Brooks DJ, Rossor MN, Fox NC, Bullock R, Klunk WE, Mathis CA, Blennow K, Barakos J, Okello AA, Martinez R, de Liano S, Liu E, Koller M, Gregg KM, Schenk D, Black R, Grundman M (2010) 11C-PiB PET assessment of change in fibrillar amyloid-beta load in patients with Alzheimer's disease treated with bapineuzumab: a phase 2, double-blind, placebo-controlled, ascending-dose study. *Lancet Neurol* 9:363–372
20. Jack CRJ, Albert MS, Knopman DS, McKhann GM, Sperling RA, Carrillo MC, Thies B, Phelps CH (2011) Introduction to the recommendations from the National Institute on Aging-Alzheimer's Association workgroups on diagnostic guidelines for Alzheimer's disease. *Alzheimers Dement* 7:257–262
21. Sperling RA, Aisen PS, Beckett LA, Bennett DA, Craft S, Fagan AM, Iwatsubo T, Jack CR Jr, Kaye J, Montine TJ, Park DC, Reiman EM, Rowe CC, Siemers E, Stern Y, Yaffe K, Carrillo MC, Thies B, Morrison-Bogorad M, Wagster MV, Phelps CH (2011) Toward defining the preclinical stages of Alzheimer's disease: recommendations from the National Institute on Aging-Alzheimer's Association workgroups on diagnostic guidelines for Alzheimer's disease. *Alzheimers Dement* 7:280–292
22. DeKosky ST, Williamson JD, Fitzpatrick AL, Kronmal RA, Ives DG, Saxton JA, Lopez OL, Burke G, Carlson MC, Fried LP, Kuller LH, Robbins JA, Tracy RP, Woolard NF, Dunn L, Snitz BE, Nahin RL, Furberg CD (2008) Ginkgo biloba for prevention of dementia: a randomized controlled trial. *JAMA* 300:2253–2262
23. Jun G, Vardarajan BN, Buros J, Yu CE, Hawk MV, Dombroski BA, Crane PK, Larson EB, Alzheimer's Disease Genetics Consortium, Mayeux R, Haines JL, Lunetta KL, Pericak-Vance MA, Schellenberg GD, Farrer LA (2012) Comprehensive search for Alzheimer disease susceptibility loci in the APOE region. *Arch Neurol* 69:1270–1279



---

# Migraine and Cluster Headache

Massimo Leone and Paola Di Fiore

---

## Introduction to Migraine and Cluster Headache

### Migraine

Migraine is a common primary episodic headache disorder. The most common migraine form is migraine without aura, with an estimated prevalence of 10–12 % in most Western societies. It is more frequent in women and usually starts before the age of 20, peaking between 35 and 45. In women, migraine often develops post menarche, worsens during menses, and may vanish during the last two trimesters of pregnancy or after menopause, suggesting an endocrine component to be involved. Two forms of migraine without aura are recognized: episodic (0–14 days per month with headache) and chronic (15 or more days per month with headache; Table 1). Usually, headache is unilateral, in the frontotemporal region, reaches its peak intensity gradually, is moderate to severe, is usually throbbing, and is aggravated by movements. It lasts 4–72 h (untreated or unsuccessfully treated) and can be associated with other symptoms, such as phonophobia, photophobia, nausea, and vomiting. Premonitory symptoms occur in 20–60 % of

patients with migraines, hours to days before headache onset. They can include depression, fatigue, irritability, sensory sensitivity, anorexia/hunger, diarrhea/constipation, sensations of heat or cold, and sweating. In migraine with aura, focal neurological symptoms, mainly in the visual field, precede the headache and last about 15–30 min.

### Cluster Headache (CH)

CH is a rare primary headache disorder characterized by severe painful attacks of strictly unilateral headache, mainly in the orbital and temporal regions, lasting 15–180 min accompanied by ipsi-

**Table 1** Diagnostic criteria of migraine without aura [1]

- 
- A. At least five attacks fulfilling criteria B–D
- 
- B. Headache attacks lasting 4–72 h (untreated or unsuccessfully treated)
- 
- C. Headache has at least two of the following four characteristics:
1. Unilateral location
  2. Pulsating quality
  3. Moderate or severe pain intensity
  4. Aggravation by or causing avoidance of routine physical activity (e.g., walking or climbing stairs)
- 
- D. During headache at least one of the following:
1. Nausea and/or vomiting
  2. Photophobia and phonophobia
- 
- E. Not better accounted for by another ICHD-3 diagnosis
- 

*ICHD3* International Classification of Headache Disorders, 3rd edition

---

M. Leone (✉) • P. Di Fiore  
Department of Neurology and Headache Centre,  
Fondazione Istituto Nazionale Neurologico Carlo  
Besta, Via Celoria 11, 20133 Milano, Italy  
e-mail: [leone@istituto-besta.it](mailto:leone@istituto-besta.it);  
[paola.difiore@libero.it](mailto:paola.difiore@libero.it)



**Table 2** Diagnostic criteria of cluster headache [1]

A. At least five attacks fulfilling criteria B–D
B. Severe or very severe unilateral orbital, supraorbital, and/or temporal pain lasting 15–180 min (when untreated)
C. Either or both of the following: <ol style="list-style-type: none"> <li>1. At least one of the following symptoms or signs, ipsilateral to the headache:           <ol style="list-style-type: none"> <li>(a) Conjunctival injection and/or lacrimation</li> <li>(b) Nasal congestion and/or rhinorrhea</li> <li>(c) Eyelid edema</li> <li>(d) Forehead and facial sweating</li> <li>(e) Forehead and facial flushing</li> <li>(f) Sensation of fullness in the ear</li> <li>(g) Miosis (pupil constriction) and/or ptosis (droopiness of body parts, mostly face)</li> </ol> </li> <li>2. A sense of restlessness or agitation</li> </ol>
D. Attacks have a frequency between one every other day and eight per day or more than half of the time when the disorder is active
E. Not better accounted for by another ICHD-3 diagnosis

*ICHD3* International Classification of Headache Disorders, 3rd edition

lateral oculo-facial autonomic symptoms, such as lacrimation, rhinorrhea, conjunctival injection (inflammation of the conjunctiva; see chapter “[Overview](#)” under part “[Eye](#)”), tearing, facial sweating, or ptosis; a sense of restlessness may be present (Table 2). The prevalence of CH is estimated to be at least 0.05–0.3 % [2] in the overall population. CH is predominant in males, but increasing in women; the ratio is now 2.5:1. The most common age of onset is the third or fourth decade of life. There are two forms of CH: episodic and chronic CH. About 80 % of CHs are episodic and are characterized by periods with daily or almost daily attacks, up to 8 per day, followed by spontaneous remission. In chronic CH, remission periods are usually absent or last less than 1 month. CH attacks often occur at fixed times of the day and of the night with a typical circadian periodicity. In episodic CH, most of cluster periods occur during spring or autumn. Alcohol; nitroglycerine, a vasodilator used in chronic heart failure (see chapter “[Heart failure](#)”); and exercise are recognized precipitants of acute cluster attacks. It is of interest to note that alcohol triggers attacks only during a cluster period but not during remission.

Although CH attacks are clearly distinguishable from migraine attacks, the two conditions share involvement of the trigeminovascular system at peripheral level and derangement of pain modulating structures within the brain. Today, both migraine and CH are regarded as neurovascular headaches, meaning that they are triggered by a complex series of neural but also vascular events.

## Pathophysiology of Head Pain and the Trigemino-vascular System

The trigeminovascular system consists of trigeminal neurons innervating cranial pain-sensitive structures such as dural, meningeal, and cerebral arteries and veins, venous sinuses, and bones. Pain information is transmitted via peripheral trigeminal first-order sensitive neurons to the trigeminal nucleus caudalis in the caudal brain stem and higher cervical spinal cord. The latter form the so-called trigeminocervical complex (Fig. 1). Pain information from the cranio-facial district is further transmitted via this complex to the ventro-posterior thalamus and then to the sensory cortex, the frontal cortex, insulae, cingulate cortex, and other pain-related brain areas (the so-called pain matrix), resulting in the experience of pain (Fig. 1).

Pain-sensitive information from the trigeminal nerve may also activate brain stem parasympathetic autonomic neurons of the superior salivatory nucleus due to a direct connection between the two systems in the brain stem. Fibers from this nucleus then run through the facial nerve to peripheral parasympathetic ganglia (e.g., the sphenopalatine ganglion); from these ganglia, neurons project to cranial vessels including dura mater vascular system and are responsible for vasodilation there (Fig. 1) [4]. Activation of parasympathetic fibers accounts for autonomic phenomena (such as lacrimation, rhinorrhea, facial sweating) accompanying CH attacks (see above, Table 2).

In addition to activation of the central pain pathway, trigeminal sensory nerve endings antidromically (“backward/upward”) release vasoactive and pro-inflammatory neuropeptides around cranial vessels provoking dilation of cranial and

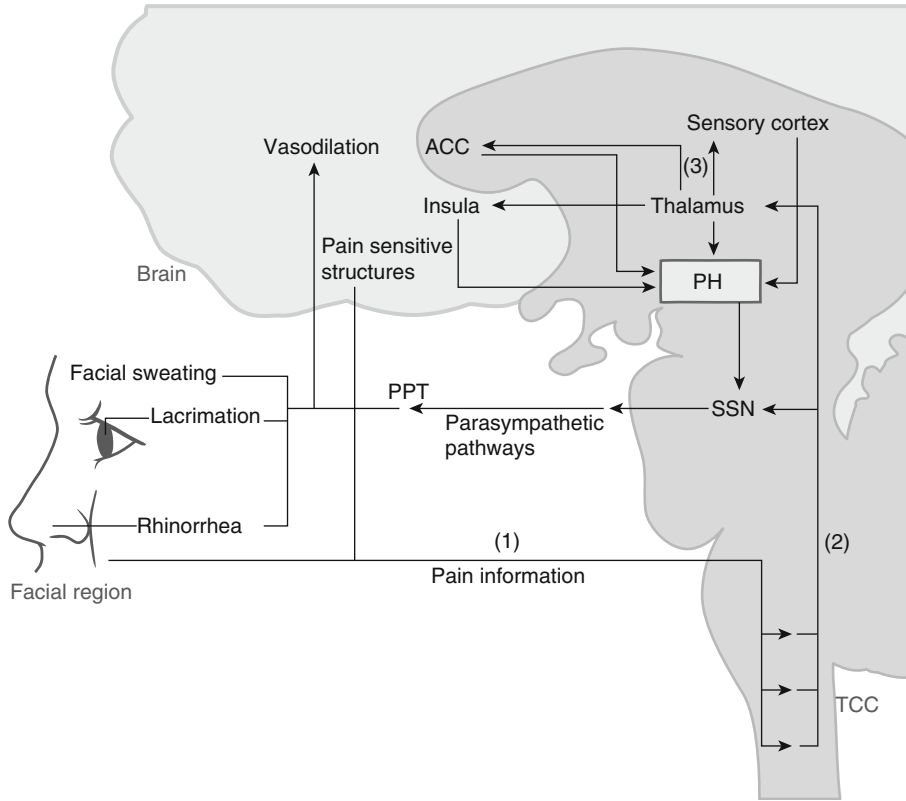

**Fig. 1** Structures and centers implicated in migraine and cluster headache. The trigeminovascular system consists of the trigeminocervical complex (*TCC*), which includes the trigeminal nucleus caudalis (*TNC*) located in the brain stem and the upper cervical spinal cord (C1 and C2) and the afferent trigeminal nerve(s), which receives and transfers pain information from facial and cranial pain-sensitive structures (e.g., blood vessels in the dura mater). The afferent first-order neurons (1) are interconnected in the *TCC* to second-order neurons (2) projecting to the thalamus. Subsequently, cortical areas involved in pain transmission (third-order sensory neurons, (3) the pain matrix) are activated (including insula, sensory cortex, and anterior cingulate cortex (*ACC*)). The posterior hypothalamus (*PH*) might have a role in

meningeal vessels and inducing a so-called sterile neurogenic inflammation. Involved neurotransmitters are calcitonin gene-related peptide (*CGRP*), substance P, neurokinin A, enkephalins, endothelin 1, somatostatin, and vasoactive intestinal peptide. *CGRP* and substance P are thought to sensitize pain receptors by inducing the release of inflammatory mediators such as histamine, bradykinin, tumor necrosis factor- $\alpha$ , nitric oxide, and serotonin (5-hydroxytryptamine, 5-HT). 5-HT has long been implicated as a key neurotransmitter

terminating and regulating attacks. It receives input from the thalamus, but also from the pain matrix, directly. The *PH* is implicated in autonomic phenomena occurring during headache attacks. These (mostly) parasympathetic symptoms can be caused by a direct effect of the hypothalamus (not shown) or by the *TCC*/ipsilateral trigeminal system via activation of the superior salivatory nucleus (*SSN*). This nucleus activates parasympathetic efferents mainly via the sphenopalatine (or pterygopalatine) ganglion (*PPT*). The *PPT* causes lacrimation, rhinorrhea, and facial sweating and is also connected to the dura mater where it can cause vasodilation. A dysfunction or disturbance in interactions between these pain areas might enable headache attacks to take place (Adapted from Leone and Bussone [3])

in migraine (and CH), and some antimigraine drugs exert their effect by binding to 5-HT receptors (most importantly 5-HT<sub>1B/1D</sub>, see below).

## Treatment of Migraine and Cluster Headache

An effective management plan must include acute treatment to relieve the pain and may also include prophylactic treatments with the aim of decreasing

attack frequency, severity, and duration and of promoting an improved responsiveness to acute treatments. Comorbidities will influence drug choice, as will the side effect profile of the drug.

### Treatment of Acute Migraine

Acute antimigraine treatment includes ergot alkaloid derivatives (ergotamine and dihydroergotamine), triptans, analgesics, and nonsteroidal anti-inflammatory drugs. Before intake of ergots, nonsteroidal anti-inflammatory drugs, analgesics, and, to a lesser extent, triptans, oral metoclopramide, or domperidone can be recommended to control nausea and vomiting. Migraine prophylaxis should be considered when attacks are frequent (more than 4 headache days per month), disabling, and acute medication is failing. Prophylaxis also helps to prevent medication overuse headache.

### Prophylactic Treatment of Migraine

Preventive medication must be given for at least 3–6 months, usually aiming at a 50 % reduction in headache frequency. Secondary end points are reduction of pain intensity and duration, reduction of acute medication intake, and an improved acute treatment efficacy. First-line preventive drugs include  $\beta$ -blockers (such as propranolol and metoprolol), flunarizine (an atypical calcium channel antagonist), pizotifen (see above), and antiepileptic drugs (such as topiramate and valproate). Second-line preventive drugs with lower efficacy include other  $\beta$ -blockers, such as bisoprolol, timolol, and atenolol; tricyclic antidepressants (see chapter “[Major depressive disorder](#)”), mainly amitriptyline; selective serotonin reuptake inhibitors; and calcium channel antagonists, such as verapamil (see above). Avoidance of food or environmental triggers; stabilization of bedtimes, mealtimes, and exercise times; limitations on the frequency of use of acute medications or analgesics; and implementation of cognitive behavioral therapies or stress management strategies are also recommended [5].

### Treatment of Acute Cluster Headache

In episodic and chronic CH, the drug of choice to treat acute attacks is subcutaneous sumatriptan. Nasal spray formulation of sumatriptan or zolmitriptan can also be used. The triptans are the first-line medication and have revolutionized the acute treatment of both migraine and CH. Triptans exert an agonistic effect on both 5-HT<sub>1B</sub> and 5-HT<sub>1D</sub> receptors. The primary sites of action are cranial blood vessels, where they lead to vasoconstriction and block the release of pro-inflammatory neuropeptides. Activation of 5-HT<sub>1D</sub> receptors on nerve endings decreases the release of pro-inflammatory peptides such as CGRP and substance P.

Second-line acute treatments include intranasal lidocaine (an anesthetic) and subcutaneous injection of octreotide (a somatostatin analog), which likely acts via vasoconstrictive effects. Inhalation of pure oxygen via a non-rebreathing facial mask is also effective but to a lesser extent.

### Prophylactic Treatment of CH

Prophylaxis of episodic and chronic CH should be tried first with verapamil. Verapamil is an L-type calcium channel blocker that is also used to treat hypertension (see chapter “[Hypertension](#)”) and angina pectoris (see chapter “[Atherosclerotic heart disease](#)”). It acts by relaxing smooth muscle cells around blood vessels, causing vasodilation. The maximum dosage depends on tolerability, and electrocardiography monitoring is recommended especially when increasing doses, to prevent atrioventricular block.

Lithium, valproic acid (likely interacting with  $\gamma$ -aminobutyric acid transmission), methysergide, and pizotifen can be used if verapamil is ineffective or contraindicated. All these prophylactic drugs can be used in combination when single therapy did not produce improvement. Methysergide is the most effective of these, yet it is ineffective in acute attacks. Today, it is no longer recommended due to its side effects. Pizotifen, while effective, is also limited by its side effects (weight gain and drowsiness) and used when other approaches fail.

When these prophylactic drugs fail, corticosteroids can be used for short periods of time and with caution. Corticosteroids such as prednisolone, prednisone, and dexamethasone are the most effective preventive agents for CH, but prolonged use leads to potentially serious adverse events, such as insulin resistance (see chapter “[Diabetes mellitus](#)”), osteoporosis (see chapter “[Osteoporosis](#)”), and hypertension (see chapter “[Hypertension](#)”). Intramuscular dexamethasone can be administered when CH attacks are aggressive [6]. At the same time, other preventive medication is to be started. Injection of local corticosteroids plus local anesthetic in the area of the greater occipital nerve ipsilateral to the pain may exert some benefit. In drug-resistant chronic CH, greater occipital nerve stimulation and deep brain stimulation of the hypothalamus are recognized procedures to treat the condition.

---

## Perspectives

In the last years, neuroimaging findings and the introduction of neurostimulation for the treatment of primary headache such as migraine and CH have provided considerable contributions to better understand the pathophysiology of these headache syndromes.

Functional imaging studies showed that several brain regions are involved in head pain processing and modulation. Hopefully, future studies will improve our knowledge on neuronal networks

operating in migraine and CH, possibly offering rationale for new therapeutic targets.

In previous years, the increased CGRP levels in jugular vein blood, during both migraine and CH attacks, suggested a fundamental role for this substance in the origin of neurovascular headaches. New treatments based on anti-CGRP antibodies for both migraine and CH are currently being developed.

---

## References

1. Headache Classification Committee of the International Headache Society (IHS) (2013) International Classification of Headache Disorders, 3rd edition (beta version). *Cephalalgia* 33:629–808
2. Tonon C, Guttman S, Volpini M, Naccarato S, Cortelli P, D’Alessandro R (2002) Prevalence and incidence of cluster headache in the Republic of San Marino. *Neurology* 58:1407–1409
3. Leone M, Bussone G (2009) Pathophysiology of trigeminal autonomic cephalalgias. *Lancet Neurol* 8: 755–764
4. May A, Goadsby PJ (1999) The trigeminovascular system in humans: pathophysiologic implications for primary headache syndromes of the neural influences on the cerebral circulation. *J Cereb Blood Flow Metab* 19:115–127
5. Evers S, Afra J, Frese A, Goadsby PJ, Linde M, May A, Sándor PS, European Federation of Neurological Societies (2009) EFNS guideline on the drug treatment of migraine – revised report of an EFNS task force. *Eur J Neurol* 16:968–981
6. May A, Leone M, Afra J, Linde M, Sándor PS, Evers S, Goadsby PJ, EFNS Task Force (2006) EFNS guidelines on the treatment of cluster headache and other trigeminal-autonomic cephalalgias. *Eur J Neurol* 13: 1066–1077

---

# Multiple Sclerosis

Markus Kipp

---

## Introduction to Multiple Sclerosis

Multiple sclerosis (MS) is a complex multifactorial polygenic disease, influenced by various factors including age, gender, hormonal, and environmental factors. Despite an unknown etiology, the (histo-) pathological hallmarks of MS lesions are well defined and include demyelination and inflammation of various brain regions. The most widely accepted hypothesis explaining MS is that autoreactive T and B cells and autoantibodies induce myelin damage, neuroinflammation, and neurodegeneration, making MS part of the group of autoimmune diseases (see also chapters “[Rheumatoid arthritis](#)” and “[Diabetes mellitus](#)”). MS affects persons of all ages, but symptoms are most likely to appear in individuals between 20 and 50 years of age. The estimated prevalence of MS is about 2.5 million people worldwide and is two to three times higher in women than in men. The diagnosis of MS requires evidence of lesions in at least two separate areas of the central nervous system (CNS), including the brain, spinal cord, and optic nerves (dissemination in space), and evidence that new lesions developed at least 1 month apart (dissemination in time). Other potential causes for CNS lesions must be excluded. Technically, diagnosis includes medical

history, neurologic exam, and magnetic resonance imaging (MRI) to detect dissemination in space and time, visual-evoked potential measurement, cerebrospinal fluid analysis to detect the levels of immune system proteins and the presence of oligoclonal bands (immunoglobulin bands in gel electrophoresis analysis), and blood tests to rule out conditions causing symptoms similar to MS. The McDonald diagnostic criteria additionally require the first MS attack, which is also known as clinically isolated syndrome (CIS), to be clinical, with features typical or suggestive of MS and with objective abnormalities on neurologic examination. Such symptoms have to last for at least 24 h.

Relapsing remitting MS (RRMS) is the most common type of MS, affecting around 85 % of MS cases. RRMS means that symptoms appear (i.e., a relapse) and then fade away either partially or completely (i.e., remitting). Benign MS is usually a subset of RRMS and comprises patients who accumulate little disability over many years or even remain clinically stable. Secondary progressive MS (SPMS) is characterized by at least one relapse followed by progressive clinical worsening over time. This progressive course may develop slowly after an initial CIS, but more commonly follows a period of well-defined RRMS. Finally, primary progressive MS (PPMS) is characterized by steady worsening of neurologic functioning, without any distinct relapses or periods of remission. A PPMS patient’s rate of progression may vary over time, with occasional plateaus or temporary improvements, but the progression is continuous.

---

M. Kipp  
Faculty of Medicine, Institute  
of Neuroanatomy, RWTH Aachen University,  
Wendlingweg 2, 52074 Aachen, NRW, Germany  
e-mail: [mkipp@ukaachen.de](mailto:mkipp@ukaachen.de)

## Pathophysiology of Multiple Sclerosis and Metabolic Alterations

On the histopathological level, MS lesions are characterized by oligodendrocyte loss and subsequent demyelination of axons, neuroaxonal loss, astroglia and microglia activation (i.e., gliosis), and, to a certain extent, regeneration of myelin around axons. Both white and gray matter areas of the brain are affected (Fig. 1). These pathological events are paralleled by the recruitment of peripheral inflammatory cells such as lymphocytes and monocytes. Several advanced magnetic resonance imaging (MRI) techniques have been developed that, compared with conventional MRI measures, are better able to capture the complexity of the pathological processes occurring in the CNS of MS patients. Among those, proton MR spectroscopy ( $^1\text{H}$ -MRS) has the unique ability to provide chemical-pathological characterization of MR-visible lesions and normal-appearing brain tissues.

$^1\text{H}$ -MRS brain imaging revealed profound changes in the level of metabolites such as *N*-acetylaspartate (NAA, a derivative of aspartic acid acting as an important metabolic precursor and osmolyte in the brain), choline, creatine, myo-inositol, glutamate (Glu), glutamine (Gln), macromolecules, lipids, and lactate. Reduced NAA levels indicate neuronal/axonal loss. Increased choline and creatine levels suggest gliosis and cell-membrane turnover (de- and remyelination), respectively. Furthermore, lactate, the end product of anaerobic glycolysis, is also increased in MS lesions [2, 3], along with Gln, fructose, and glucose (at early stages of MS) highlighting severe metabolic changes (Fig. 2).

Interestingly, metabolic abnormalities were also found in the “normal-appearing” white matter, hence in regions which are not yet affected by demyelination. Furthermore, studies have demonstrated a reduction in cerebral blood flow of different white [5] and gray matter regions [6] in MS patients

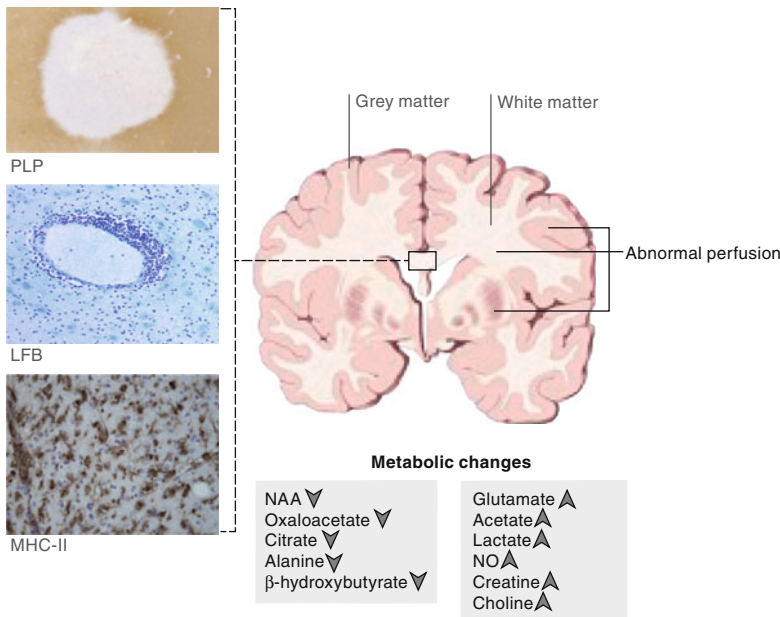

**Fig. 1** Pathological and metabolic changes in the brain of an MS patient. Classical active MS lesions [1] can be found in the white and gray matter of the brain. Hallmarks of such lesions are demyelination as indicated by loss of proteolipid protein (PLP) staining (top-left image) and increased luxol fast blue (LFB) staining (middle-left), recruitment of inflammatory

cells into the perivascular space, and massive accumulation of major histocompatibility complex (MHC) II expressing macrophages (bottom-left image). Likewise, abnormal perfusion is present at multiple locations in the CNS. The brain and cerebrospinal fluid demonstrate abnormal levels of several metabolites. NAA *N*-acetyl aspartate, NO nitric oxide



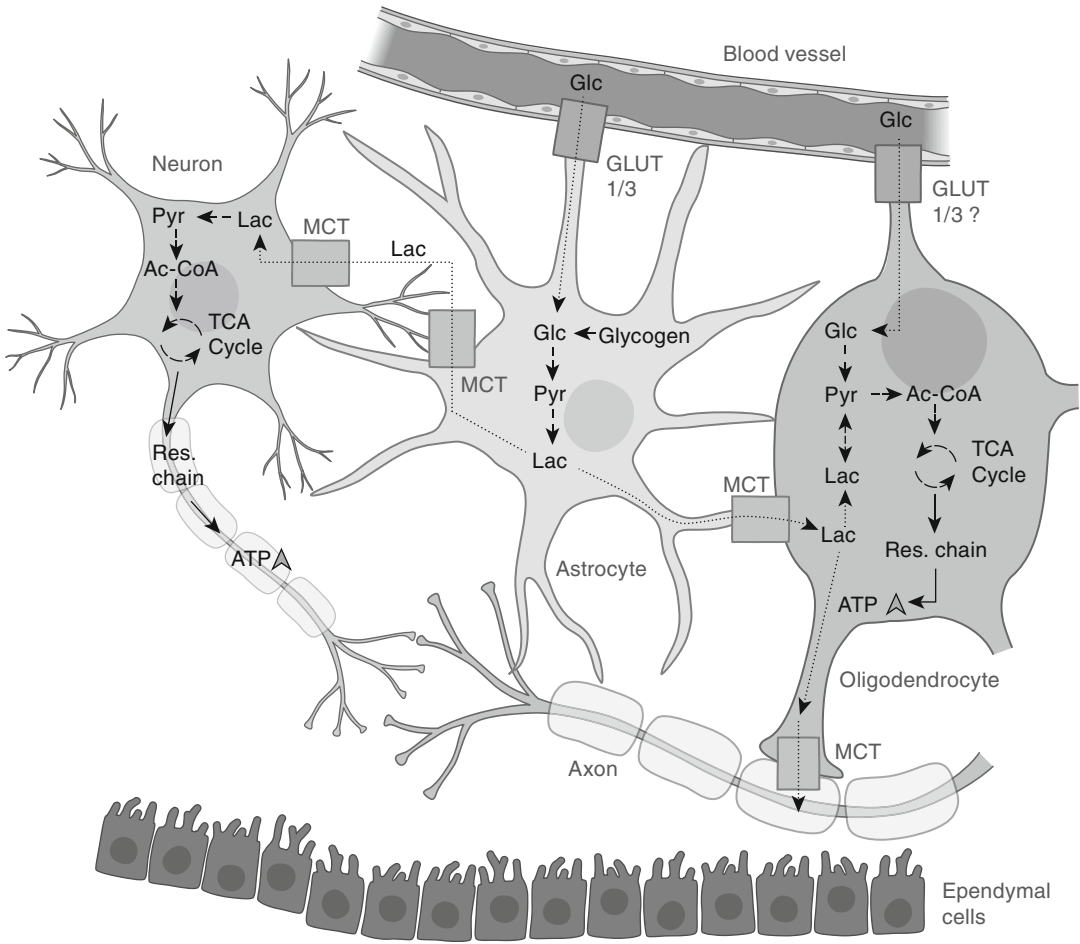

**Fig. 2** Movement of metabolites. The brain is mainly fueled by glucose (*Glc*), transported via the blood and taken up by glucose transporters (*GLUT* 1 and 3 (expressed in endothelial and brain cells, respectively). Alternatively, astrocytes are the main reservoir of glycogen in the brain. Therefore, they might serve as supporters for neurons and oligodendrocytes during energy deprivation periods. According to the lactate (*Lac*) shuttle hypothesis for energy transfer between cells, a heavily glycolytic (i.e., non-oxidative) cell (e.g., an astrocyte) produces large amounts of pyruvate (*Pyr*) and subsequently lactate, which is then transported out of the cell along its concentration gradient through specific

monocarboxylate transporters (*MCTs*). The extracellular lactate is taken up via distinct *MCTs*. Intracellularly, lactate is recycled to pyruvate and transformed into acetyl-CoA (*Ac-CoA*), which is metabolized in the tricarboxylic acid cycle (*TCA*, also called citric acid cycle) to finally produce ATP via oxidative phosphorylation in the respiratory chain of the mitochondria. This interdependence is hypothesized to occur mainly between astrocytes (*center*) and neurons (*left*). Recently, oligodendrocytes have been included in the hypothesis as critical intermediaries for lactate transport to neurons [4]. Oligodendrocytes are also able to take up glucose directly from the endothelial cells of the vessels, probably via *GLUT* 1 and 3 as well

(Fig. 1). The globally decreased blood perfusion in MS is thought to result from diffuse perivascular inflammation leading to microvascular damage, thrombosis, and fibrin deposition. Furthermore, hypoperfusion might result from widespread astrocyte dysfunction, which contributes to the regulation of vascular tone in the CNS [7].

Metabolic alterations in MS patients can also be detected by <sup>1</sup>H-MRS in biofluids, most importantly cerebrospinal fluid (CSF), instead of imaging the brain. This enables quantification of a much larger range of biochemical compounds. In this context, it is important to note that many MS lesions are located in the periventricular white

matter of the brain as well as in superficial areas of the spinal cord, which are close to the CSF space. Since MS lesions are not routinely biopsied, CSF analysis remains an important tool to discern MS pathology. CSF is a clear, colorless fluid surrounding the brain and the spinal cord to protect them from injury and is predominantly produced by the choroid plexus, a dense network of blood vessels located in each of the four ventricles. CSF contains trace proteins, electrolytes, and nutrients that are needed for the metabolism and normal function of the brain. Remarkably, it also serves to remove waste products from the CNS parenchyma and is thus a vital source of information on physiological and pathological processes occurring within the brain parenchyma.

In animal models of MS, the concentration of several metabolites was altered in the CSF. As an example, significantly lower levels of arginine were observed during the early stage of experimental autoimmune encephalomyelitis (EAE), which is one of the most commonly used MS animal models. Arginine is the main substrate for nitric oxide (NO) synthesis, and its reduction likely results from increased activity of inducible NO synthase (iNOS) in activated immune cells and microglia. This NO can react with the free radical superoxide  $O_2^-$ , arising from oxidative phosphorylation in the mitochondria to create peroxynitrite anion, a very reactive oxidizing agent, capable of inducing cell death through multiple pathways. Thus, lowered levels of arginine might be an indirect indicator of cell stress and death.

Furthermore, levels of alanine and branched-chain amino acids (leucine, isoleucine, and valine) are decreased in early EAE and likely MS. These amino acids are utilized as a source of pyruvate for energy metabolism; thus, decreased levels indicate increased cell turnover. As the onset of EAE is associated with maximum infiltration of the CNS by blood monocytes and T cells, the observed decrease may suggest these metabolites are utilized for energy metabolism by invading cells [8].

Human MS patients additionally show increased levels of lactate in the CSF correlating with disease activity in the brains of patients with CIS [9]. Increased levels of lactate likely arise from increased anaerobic glycolysis, an attempt

to compensate for reduced oxidative phosphorylation caused by perturbed microcirculation and hypoxia-like injury during MS plaque formation. Continued perturbation of mitochondrial function results in cellular energy deficit and loss of mitochondrial transmembrane potential ultimately leading to apoptotic cell death. Thus, the increase in lactate in active plaques and CSF can be interpreted as a result of inflammation, local ischemia, and mitochondrial dysfunction.

Similarly, the concentration of  $\beta$ -hydroxybutyrate (a ketone body and substrate for gluconeogenesis) is increased in the CSF of CIS patients corresponding to the presence of inflammatory lesions [9]. Recent evidence suggests that astrocytes are in principle capable of gluconeogenesis and glucose release. Thus, the increased levels of  $\beta$ -hydroxybutyrate may reflect a perturbation of astrocytic gluconeogenesis potentially due to the presence of inflammatory plaques or due to reduced cerebral blood flow as a result of a perturbation of microcirculation.

Another important metabolic factor playing a role in MS pathogenesis is nitric oxide (NO). NO products are significantly raised in the CSF of MS patients [10]. NO competitively inhibits the binding of oxygen to mitochondrial respiratory complex, and, thus, its increase perturbs ATP synthesis [11]. This condition, in which oxygen is in principle available but cells are unable to use it, mimics hypoxia and is called histotoxic or metabolic hypoxia. Again, subsequent mitochondrial respiratory dysfunction may cause cell death and, in consequence, demyelination and neurodegeneration.

Elevation of Glu levels in CSF, a known CNS neurotoxic trigger, compounded by low levels of oxaloacetate (an inhibitor of neuronal cell death, Fig. 1) may contribute to axonal loss and represents an area for further study [12].

---

## Treatment of Multiple Sclerosis

Despite tremendous scientific efforts, to date, MS has no cure. Treatment usually focuses on strategies to treat acute MS attacks, to lower attack frequency, and to reduce progression (i.e., progression of clinical disability).



Corticosteroids are mainly used to reduce the inflammation that spikes during a relapse. These drugs inhibit lymphocyte proliferation, synthesis of pro-inflammatory cytokines, and expression of cell surface molecules required for immune function (see chapter “[Overview](#)” under part “Immune system”). Furthermore, it is believed that corticosteroids stabilize the blood-brain barrier (BBB), for example, by decreasing the expression of angiotensin-1 and vascular endothelial growth factor A (VEGFA), both well known to regulate the permeability of the BBB (see chapters “[Overview](#)” under part “Brain” and “[Stroke](#)”). Alternatively, plasmapheresis (meaning removal of blood components) might be applied to help combat severe symptoms of relapses in patients who are not responding to corticosteroids.

Disease-modifying drugs are prescribed with the aim to reduce relapse frequency. Currently, this group includes  $\beta$ -interferons (Avonex, Betaseron, Extavia, and Rebif), fingolimod (Gilenya), glatiramer acetate (Copaxone), mitoxantrone (Novantrone), natalizumab (Tysabri), teriflunomide (Aubagio), and dimethyl fumarate (Tecfidera or BG-12).

$\beta$ -interferons balance the expression of pro- and anti-inflammatory agents in the brain and reduce the number of inflammatory cells that cross the BBB.

Fingolimod, which is in vivo converted to its active form fingolimod phosphate, suppresses lymphocyte egress from lymphoid tissues into the circulation.

Glatiramer acetate is a mixture of random polymers of four amino acids, which mimics the antigenic properties of the myelin basic protein, a component of the myelin sheath of nerves with which it competes for presentation to T cells.

Mitoxantrone is a type II topoisomerase inhibitor; it disrupts DNA synthesis and DNA repair in both healthy cells and cancer cells. Hence, it suppresses the proliferation of T cells, B cells, and macrophages (see chapter “[Overview](#)” under part “Immune system”), impairs antigen presentation, and decreases the secretion of pro-inflammatory cytokines.

Natalizumab is a humanized monoclonal antibody against the cell adhesion molecule integrin

$\alpha 4$  and reduces the ability of inflammatory immune cells to pass through the BBB. Teriflunomide belongs to a class of drugs called pyrimidine synthesis inhibitors. Its ability to inhibit the mitochondrial enzyme dihydroorotate dehydrogenase, which is relevant for the de novo synthesis of pyrimidine, is believed to exert the most important therapeutic effect. By inhibiting dihydroorotate dehydrogenase and diminishing DNA synthesis, teriflunomide has a cytostatic effect on proliferating B and T cells.

Dimethyl fumarate is a lipophilic, highly mobile molecule in human tissue. As a electrophilic compound, dimethyl fumarate is rapidly attacked by the detoxifying agent glutathione (GSH). GSH depletion and subsequent induction of the anti-inflammatory stress protein HO-1 is thought to be one of the mechanisms responsible for the immunomodulatory actions of dimethyl fumarate. Other postulated mechanisms of action include direct cytoprotective effects through upregulation of nuclear factor (erythroid-derived 2)-like 2 (Nrf2) and subsequent induction of an antioxidant response.

---

## Influence of Treatment on Metabolism

There is some evidence that the metabolic changes in MS can be ameliorated by the administration of disease-modifying drugs. For example, CIS patients who received glatiramer acetate or interferon beta 1b showed improvement in brain neuroaxonal integrity, as indicated by an increased NAA/creatinine ratio [13, 14]. However, our knowledge about the efficacy of disease-modifying drugs to modulate metabolic changes in MS is in its infancy and warrants further studies. One has to point out that currently available immune-directed therapies have been shown to decelerate the inflammatory process in MS and, thus, restore acute clinical deficits, which occur during a relapse. However, such therapy is less effective in preventing the progression of the disease and neurodegeneration, which appear to be at least in part independent from inflammatory attacks.

## Perspectives

Clearly, several metabolic pathways are disturbed in the CNS of MS patients (see above). However, we are far from understanding how these alterations impact cellular physiology and whether a manipulation of these pathways might result in new therapeutic options in the future. Recent findings suggest that neurons, astrocytes, and oligodendrocytes form a so-called tri-cellular compartmentation of brain metabolism [15], meaning that complex metabolic pathways are scattered over different cell types and the metabolites are then transported to their target cells. This is, for example, well described for NAA metabolism and catabolism. Aspartate needed for NAA production can only be synthesized *de novo* in astrocytes and is transported to neurons in the form of glutamine. In neurons, NAA is then assembled and released. Subsequently, NAA is hydrolyzed to acetate and aspartate by aspartoacylase, which is predominantly located in oligodendroglia. Following this theory, oligodendrocytes and astrocytes are pivotal for neuronal survival and functioning by providing energy metabolites to axons and/or neuronal cell bodies. A better understanding of these cellular interactions will help to generate new treatment strategies and diagnostic tools in the future.

## References

1. van der Valk P, Amor S (2009) Preactive lesions in multiple sclerosis. *Curr Opin Neurol* 22(3):207–213
2. Sajja BR, Wolinsky JS, Narayana PA (2009) Proton magnetic resonance spectroscopy in multiple sclerosis. *Neuroimaging Clin N Am* 19(1):45–58
3. Simone IL, Tortorella C, Federico F et al (2001) Axonal damage in multiple sclerosis plaques: a combined magnetic resonance imaging and 1H-magnetic resonance spectroscopy study. *J Neurol Sci* 182(2):143–150
4. Morrison BM, Lee Y, Rothstein JD (2013) Oligodendroglia: metabolic supporters of axons. *Trends Cell Biol* 23:644–651
5. Papadaki EZ, Mastrodomos VC, Amanakis EZ et al (2012) White matter and deep gray matter hemodynamic changes in multiple sclerosis patients with clinically isolated syndrome. *Magn Reson Med* 68(6):1932–1942
6. Inglese M, Adhya S, Johnson G et al (2008) Perfusion magnetic resonance imaging correlates of neuropsychological impairment in multiple sclerosis. *J Cereb Blood Flow Metab* 28(1):164–171
7. Filosa JA, Iddings JA (2013) Astrocyte regulation of cerebral vascular tone. *Am J Physiol Heart Circ Physiol* 305(5):H609–H619
8. Noga MJ, Dane A, Shi S et al (2012) Metabolomics of cerebrospinal fluid reveals changes in the central nervous system metabolism in a rat model of multiple sclerosis. *Metabolomics* 8(2):253–263
9. Lutz NW, Viola A, Malikova I et al (2007) Inflammatory multiple-sclerosis plaques generate characteristic metabolic profiles in cerebrospinal fluid. *PLoS One* 2(7):e595
10. Rejdak K, Petzold A, Stelmasiak Z, Giovannoni G (2008) Cerebrospinal fluid brain specific proteins in relation to nitric oxide metabolites during relapse of multiple sclerosis. *Mult Scler* 14(1):59–66
11. Smith KJ, Lassmann H (2002) The role of nitric oxide in multiple sclerosis. *Lancet Neurol* 1(4):232–241
12. Sinclair AJ, Viant MR, Ball AK et al (2010) NMR-based metabolomic analysis of cerebrospinal fluid and serum in neurological diseases—a diagnostic tool? *NMR Biomed* 23(2):123–132
13. Arnold DL, Narayanan S, Antel S (2013) Neuroprotection with glatiramer acetate: evidence from the PreCISE trial. *J Neurol* 260(7):1901–1906
14. Narayanan S, De Stefano N, Francis GS et al (2001) Axonal metabolic recovery in multiple sclerosis patients treated with interferon beta-1b. *J Neurol* 248(11):979–986
15. Amaral AI, Meisingset TW, Kotter MR, Sonnewald U (2013) Metabolic aspects of neuron-oligodendrocyte-astrocyte interactions. *Front Endocrinol* 4:54

---

# Down Syndrome

Maria D. Torres and Jorge Busciglio

---

## Introduction to Down Syndrome

Down syndrome (DS) or trisomy of chromosome 21 is the most prevalent cause of genetic intellectual disability affecting approximately 1 in 700 live births. Most DS cases are caused by full triplication of chromosome 21, and a small number of cases arise from mosaicism or chromosomal translocations, resulting in multiple medical and physical manifestations. Common characteristics of individuals with DS include skeletal anomalies, craniofacial alterations, hypotonia, increased incidence of congenital heart disease and seizures, abnormalities of the gastrointestinal tract, thyroid dysfunction, and premature aging [1]. Additional clinical features include altered folate metabolism and hormone imbalances [2, 3]. Neurological changes include reduced brain mass, impaired neuronal differentiation, aberrant dendritic spine morphology, and defects in synaptic plasticity [4]. Most middle-aged individuals with DS develop Alzheimer's disease (see chapter "Alzheimer's disease") due to increased expression of the amyloid precursor protein gene located on chromosome 21 [5]. Alterations

in reactive oxygen species (ROS) and energy metabolism have long been associated with the development and progression of DS neuropathology [6]. This section focuses on the role of oxidative stress, mitochondrial dysfunction, and hypothyroidism in DS.

---

## Pathophysiology of Down Syndrome and Metabolic Alterations

### Altered Oxidative Stress and Energy Metabolism in DS

Oxidative stress is a prominent feature associated with DS [7]. Enhanced lipid peroxidation (which can cause DNA damage) has been documented [8], as well as differential expression of oxidative stress-related genes [9]. Similarly, DS cortical neurons exhibit intracellular accumulation of ROS, increased lipid peroxidation, and reduced neuronal survival [10]. Another feature of DS pathology closely related to oxidative stress is mitochondrial dysfunction (Fig. 1). DS cells exhibit reduced mitochondrial transmembrane potential, ATP production, and oxidoreductase activity [9]. These energy deficits lead to an abnormal pattern of protein processing and secretion in DS including intracellular accumulation of A $\beta$  [11]. Mitochondria are not only the main intracellular source of ROS and free radicals but also play a critical role in apoptotic pathways. Increased levels of ROS and mutations in

---

M.D. Torres • J. Busciglio (✉)  
Department of Neurobiology and Behavior,  
Institute for Memory Impairments and Neurological  
Disorders (iMIND), Center for the Neurobiology  
of Learning and Memory (CNLM), University  
of California – Irvine, 3216 Biological Sciences III,  
Irvine, CA 92697-4545, USA  
e-mail: [mdtorres@uci.edu](mailto:mdtorres@uci.edu); [jbuscigl@uci.edu](mailto:jbuscigl@uci.edu)

**Fig. 1** Schematic representation of the proposed pathological cascade leading to Alzheimer's disease in Down syndrome. Down syndrome is caused by triplication, mosaicism, or translocation of chromosome 21 and characterized by altered expression of genes on chromosome 21, but also other genes. These changes cause multiple derangements (mitochondrial dysfunction, oxidative damage,  $\beta$ -amyloid accumulation) that interact and favor each other reciprocally. In turn, this causes energy depletion, neuronal dysfunction, and finally, neuronal death. The latter factors, along with  $\beta$ -amyloid accumulation, all contribute to dementia and Alzheimer's disease (Adapted from Lott et al. [7])

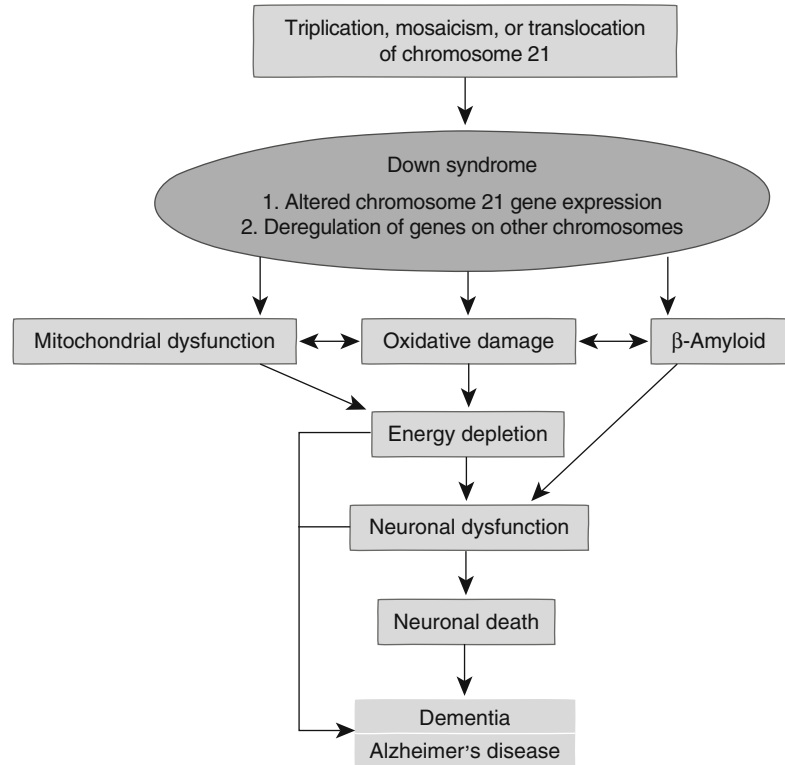

mitochondrial DNA can initiate a series of molecular events leading to activation of apoptosis [12]. In this regard, reduced mitochondrial activity in DS appears to represent an adaptation to prevent cellular damage and preserve basic cellular functions. In fact, upon stimulation, DS mitochondria possess the capacity to increase ATP production [13]. However, sustained increase of mitochondrial activity leads to lipid peroxidation and increased cell death. Interestingly, down-regulation of mitochondrial activity to prevent oxidative damage has been observed in different organisms and cell types [14].

DS neurons and astrocytes also show a reduction in thrombospondin-1 (TSP-1) expression and secretion contributing to dendritic spine abnormalities [15]. TSP-1 is an astrocyte-secreted protein involved in the formation of excitatory synapses. Deficits in TSP-1 lead to defects in learning and memory in mice (M. Torres and J. Busciglio unpublished data). A possible explanation is that reduced TSP-1 levels are linked to interferon (IFN) hypersensitivity. Overexpression

of and hypersensitivity to IFN- $\gamma$  have been linked to the presence of two IFN receptor genes on chromosome 21 [16]. IFN- $\gamma$  inhibits TSP-1 glycosylation and reduces its cellular levels and secretion [17, 18].

Endocrine dysfunction is another prominent medical feature of Down syndrome. In particular, the function of the thyroid gland is often compromised. The latter secretes several hormones, i.e., thyroxine ( $T_4$ ), triiodothyronine ( $T_3$ ), and calcitonin, which regulate metabolism, heart rate, and growth. Alterations in their balance can lead to short stature, skin problems, and intellectual disability. It has been hypothesized that the development of thyroid dysfunction in DS is influenced by oxidative stress [19] or deregulation of genes on chromosome 21 that participate in the immune response [20]. Individuals with DS are likely to have congenital hypothyroidism or develop thyroid dysfunction later in adulthood. The incidence of hypothyroidism in individuals with DS ranges from 3 to 54 %, and recent studies suggest that the prevalence increases after the age of 40 [21].

Hypothyroidism results in decreased  $T_4$  and  $T_3$ , which are important for physical and intellectual development by affecting protein synthesis and increasing metabolic rate, bone growth, and sensitivity to catecholamines. Symptoms of hypothyroidism further include hypotonia, enlarged tongue, small stature, skin problems, constipation, and lethargy [22]. Because many of the characteristics involving hypothyroidism overlap with features of DS, it is difficult to get an initial diagnosis.

Thyroid dysfunction is normally diagnosed through blood analysis of thyroid stimulating hormone (TSH). As part of a feedback loop, decreased  $T_4$  leads to increased levels of TSH to help stimulate more  $T_4$  production. Ultimately, early diagnosis of hypothyroidism is critical for preventing deterioration of physical and mental development in DS individuals. Individuals who develop thyroid autoimmune disease are more likely to develop other endocrine disorders including diabetes mellitus (see chapter “[Diabetes mellitus](#)”). Thus, proper endocrine screening should be routine in individuals with DS.

---

## Treatment of Down Syndrome and Its Influence on Metabolism

To date, there is no cure for Down syndrome. Existing treatments are directed to alleviate or prevent clinical complications such as congenital heart defects or gastrointestinal blockage. Additionally, physical and speech therapy are available to further assist in providing a better lifestyle for DS individuals. Nutritional therapies have been used to enhance cognition although there is little data supporting their effectiveness [23].

Antioxidants (such as resveratrol, celastrol, vitamins, and Coenzyme Q10) are used to protect cells against oxidative damage through the clearance of free radical intermediates and by delaying lipid peroxidation. Antioxidants increase viability of DS neurons in culture and prevent neuronal death while improving spatial learning in a DS mouse model [10, 24]. Coenzyme Q10, a cofactor of the electron transport chain, has shown promising results to treat mitochondrial dysfunction [25], acting as a scavenger of ROS

and preventing lipid peroxide-induced DNA damage (in conjunction with vitamin E) [26]. Recent work indicates that Coenzyme Q10 supplementation restores the antioxidant/oxidant balance in plasma in children with DS [27]. Considering the high prevalence of Alzheimer’s disease (AD) in DS individuals, some interventions directed at treating AD have been tested. However, acetylcholinesterase inhibitors and the NMDA receptor antagonist memantine (common AD treatments; see chapter “[Alzheimer’s disease](#)”) have been unsuccessful or inconclusive when applied to DS patients [28].

Hypothyroidism in general and in DS is easily controlled with  $T_4$  replacement therapy. However, artificial elevation of  $T_4$  levels reduces TSH (see above), which can lead to significant side effects. Because TSH stimulates production of thyroid hormones, reduction of TSH leads to decreased hormone secretion affecting hormones such as calcitonin. Calcitonin is important for preventing  $Ca^{2+}$  loss (see chapter “[Overview](#)” under part “Teeth and bones”), and synthetic replacement of  $T_4$  has been associated with increased osteoporosis (see chapter “[Osteoporosis](#)”) [29]. Nutritional therapies such as iodine, L-tyrosine, and zinc have also been suggested for treatment of hypothyroidism [30].

---

## Perspectives

Given the genetic and phenotypic complexity underlying Down syndrome, therapeutic interventions have been limited. The significant increase in life expectancy that individuals with DS enjoy today requires to be complemented with effective treatments to enhance cognition and to prevent age- and AD-related cognitive decline. Dendritic spine pathology has been associated with intellectual disability in DS and other neurological disorders, yet no therapeutic approach exists to prevent or restore spine structure and function. This is a promising area of active research, which may pave the way for the discovery of new therapies to ameliorate functional connectivity at the cellular level in DS and other neurodevelopmental and neurodegenerative conditions.

## References

- Roizen NJ, Patterson D (2003) Down's syndrome. *Lancet* 361:1281–1289
- Shaw CK, Thapalial A, Nanda S, Shaw P (2006) Thyroid dysfunction in Down syndrome. *Kathmandu Univ Med J (KUMJ)* 4:182–186
- Patterson D (2009) Molecular genetic analysis of Down syndrome. *Hum Genet* 126:195–214
- Lott IT (2012) Neurological phenotypes for Down syndrome across the life span. *Prog Brain Res* 197:101–121
- Mann DM, Esiri MM (1989) The pattern of acquisition of plaques and tangles in the brains of patients under 50 years of age with Down's syndrome. *J Neurol Sci* 89:169–179
- Coskun PE, Busciglio J (2012) Oxidative stress and mitochondrial dysfunction in Down's syndrome: relevance to aging and dementia. *Curr Gerontol Geriatr Res* 2012:383170
- Lott IT, Head E, Doran E, Busciglio J (2006) Beta-amyloid, oxidative stress and down syndrome. *Curr Alzheimer Res* 3:521–528
- Brooksbank BW, Martinez M, Balazs R (1985) Altered composition of polyunsaturated fatty acyl groups in phosphoglycerides of Down's syndrome fetal brain. *J Neurochem* 44:869–874
- Slonim DK, Koide K, Johnson KL, Tantravahi U, Cowan JM, Jarrah Z, Bianchi DW (2009) Functional genomic analysis of amniotic fluid cell-free mRNA suggests that oxidative stress is significant in Down syndrome fetuses. *Proc Natl Acad Sci U S A* 106:9425–9429
- Busciglio J, Yankner BA (1995) Apoptosis and increased generation of reactive oxygen species in Down's syndrome neurons in vitro. *Nature* 378:776–779
- Busciglio J, Pelsman A, Wong C, Pigino G, Yuan M, Mori H, Yankner BA (2002) Altered metabolism of the amyloid beta precursor protein is associated with mitochondrial dysfunction in Down's syndrome. *Neuron* 33:677–688
- Wang C, Youle RJ (2009) The role of mitochondria in apoptosis\*. *Annu Rev Genet* 43:95–118
- Helguera P, Seiglie J, Rodriguez J, Hanna M, Helguera G, Busciglio J (2013) Adaptive downregulation of mitochondrial function in down syndrome. *Cell Metab* 17:132–140
- Pfeiffer M, Kayzer EB, Yang X, Abramson E, Kenaston MA, Lago CU, Lo HH, Sedensky MM, Lunceford A, Clarke CF, Wu SJ, McLeod C, Finkel T, Morgan PG, Mills EM (2011) *Caenorhabditis elegans* UCP4 protein controls complex II-mediated oxidative phosphorylation through succinate transport. *J Biol Chem* 286:37712–37720
- Garcia O, Torres M, Helguera P, Coskun P, Busciglio J (2010) A role for thrombospondin-1 deficits in astrocyte-mediated spine and synaptic pathology in Down's syndrome. *PLoS One* 5:e14200
- Iwamoto T, Yamada A, Yuasa K, Fukumoto E, Nakamura T, Fujiwara T, Fukumoto S (2009) Influences of interferon-gamma on cell proliferation and interleukin-6 production in Down syndrome derived fibroblasts. *Arch Oral Biol* 54:963–969
- Nickoloff BJ, Riser BL, Mitra RS, Dixit VM, Varani J (1988) Inhibitory effect of gamma interferon on cultured human keratinocyte thrombospondin production, distribution, and biologic activities. *J Invest Dermatol* 91:213–218
- Maheshwari RK, Banerjee DK, Waechter CJ, Olden K, Friedman RM (1980) Interferon treatment inhibits glycosylation of a viral protein. *Nature* 287:454–456
- Kanavin OJ, Aaseth J, Birketvedt GS (2000) Thyroid hypofunction in Down's syndrome: is it related to oxidative stress? *Biol Trace Elem Res* 78:35–42
- Kennedy RL, Jones TH, Cuckle HS (1992) Down's syndrome and the thyroid. *Clin Endocrinol (Oxf)* 37:471–476
- Chen MH, Chen SJ, Su LY, Yang W (2007) Thyroid dysfunction in patients with Down syndrome. *Acta Paediatr Taiwan* 48:191–195
- Carroll KN, Arbogast PG, Dudley JA, Cooper WO (2008) Increase in incidence of medically treated thyroid disease in children with Down syndrome after rerelease of American Academy of Pediatrics Health Supervision guidelines. *Pediatrics* 122:e493–e498
- Lott IT (2012) Antioxidants in Down syndrome. *Biochim Biophys Acta* 1822:657–663
- Shichiri M, Yoshida Y, Ishida N, Hagihara Y, Iwahashi H, Tamai H, Niki E (2011) alpha-Tocopherol suppresses lipid peroxidation and behavioral and cognitive impairments in the Ts65Dn mouse model of Down syndrome. *Free Radic Biol Med* 50:1801–1811
- Tiano L, Busciglio J (2012) Mitochondrial dysfunction and Down's syndrome: is there a role for coenzyme Q(10)? *Biofactors* 37:386–392
- Tiano L, Padella L, Santoro L, Carnevali P, Principi F, Brugè F, Gabrielli O, Littarru GP (2012) Prolonged coenzyme Q10 treatment in Down syndrome patients: effect on DNA oxidation. *Neurobiol Aging* 33(626): e1–e8
- Miles MV, Patterson BJ, Chalfonte-Evans ML, Horn PS, Hickey FJ, Schapiro MB, Steele PE, Tang PH, Hotze SL (2007) Coenzyme Q10 (ubiquinol-10) supplementation improves oxidative imbalance in children with trisomy 21. *Pediatr Neurol* 37:398–403
- de la Torre R, Dierssen M (2012) Therapeutic approaches in the improvement of cognitive performance in Down syndrome: past, present, and future. *Prog Brain Res* 197:1–14
- Fowler PB, McIvor J, Sykes L, Macrae KD (1996) The effect of long-term thyroxine on bone mineral density and serum cholesterol. *J R Coll Physicians Lond* 30:527–532
- Thiel R, Fowkes SD (2007) Down syndrome and thyroid dysfunction: should nutritional support be the first-line treatment? *Med Hypotheses* 69:809–815

---

**Part II**

**Eye**

---

# Overview

Anja Mataruga and Frank Müller

---

## Anatomy and Physiology of the Eye

Vision is our dominant sense. The eyes, specialized for the detection of light, are our most important sensory organs, providing approximately 70–80 % of our total sensory information. The optical apparatus projects an image of our environment onto the back of the eye covered by the retina. The retina is a neuronal tissue originating from the brain during embryonic development and is, thus, a true part of the central nervous system. The retina is a well-layered, appr. 200  $\mu\text{m}$  thick tissue and can be divided into an outer part that harbors the light-sensitive cells – the rod and cone photoreceptor cells – and an inner part that comprises a neuronal network [1]. This network performs the first steps of information processing before the signal is relayed by the retinal ganglion cells to the brain via the optic nerve. A human retina harbors around 120 million rod and 6 million cone photoreceptor cells. Rods are highly sensitive, can respond to single light quanta, and provide vision during night and at twilight. Cones are less sensitive and provide color vision during daylight. Behind the retina, two more layers are located: the retinal pigment epithelium (RPE) and the choroid (see Fig. 1), a dense network of blood capillaries, which provides nutrients and oxy-

gen to the photoreceptors. Both are separated by Bruch's membrane, an elastin- and collagen-rich structure [2].

Due to its function, the eye has to cope with special problems. Retinal cells are the only neurons exposed to light. Bright illumination can result in the generation of free radicals that damage the retinal cells (see below). As photoreceptors (like most other central neurons) cannot be replaced, the eye has developed several mechanisms of protection. The optical apparatus absorbs high-energy ultraviolet light, which would otherwise damage the retina [3]. Moreover, in the center of the retina, protective pigments are embedded that absorb light of short wavelengths, giving this area a yellowish appearance, called *macula lutea* (Latin: yellow spot) or briefly macula (Fig. 1a). Finally, the light-sensitive segments of the rod and cone photoreceptors are continuously renewed.

The eyeball is well protected in a cavity of the skull called orbit. The frontal part of the human eye can be covered by the eyelids. The surface of the eye is moisturized by tears produced by the lacrimal gland (situated in the upper outer part of the orbit). Tears are drained by the lacrimal puncta in the inner corner of the eyelids via the lacrimal sac into the nose (see chapter “**Glaucoma**”). Most of the eyeball is covered by the tough white sclera (Fig. 1a). In the front, the sclera changes over to the transparent cornea, the first and most refractive part of the optical apparatus. The iris is the colored part of the eye. It is a pigmented muscle tissue situated between the

---

A. Mataruga • F. Müller (✉)  
Institute of Complex Systems 4, Zelluläre Biophysik  
(ICS-4), Forschungszentrum Jülich GmbH,  
Leo-Brandt-Straße, Geb.15.1, 52425 Jülich, Germany  
e-mail: [a.mataruga@fz-juelich.de](mailto:a.mataruga@fz-juelich.de);  
[f.mueller@fz-juelich.de](mailto:f.mueller@fz-juelich.de)



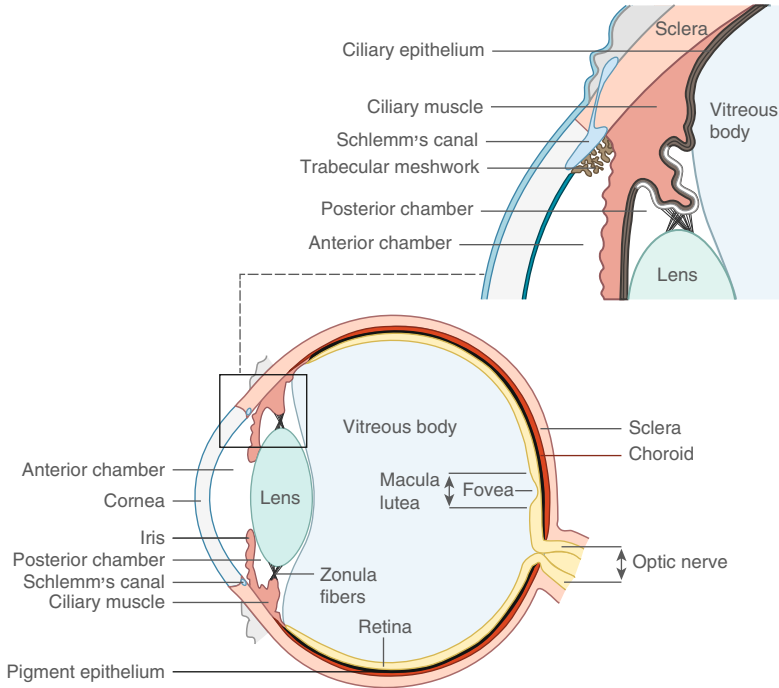

**Fig. 1** Schematic cross section of an eye. The different layers perform important tasks: the choroid is a layer of blood vessels important for photoreceptor supply. The retina is a neuronal tissue comprising the photoreceptor cells, a network of neurons, and the retinal ganglion cells as output neurons that relay the information to the brain; it also contains the macula lutea with the fovea, the central part of the retina with the highest visual acuity. The retinal pigment epithelium, a monolayer of pigmented cells that forms part of the blood-retinal barrier, is involved in the

regeneration of the photopigment and the phagocytosis of the photoreceptors' outer segments. The vitreous body is a jellylike transparent substance that maintains the eye in its spherical shape. Inset: Structures responsible for the control of aqueous humor. The ciliary epithelium secretes aqueous humor into the posterior chamber. The trabecular meshwork is a spongy tissue, which drains the aqueous humor from the anterior chamber together with Schlemm's canal

cornea and lens. Depending on the brightness of ambient light, the iris can contract or expand, thus changing the diameter of the pupil and controlling the amount of light falling into the eye. The lens is suspended by the zonula fibers attached to the ciliary muscles. Humans can adjust their focus to different viewing distances by contracting the ciliary muscles, which ultimately leads to changes in the shape of the lens. For their function, the cornea and lens must be transparent and, therefore, devoid of blood vessels. They are nourished by diffusion from the aqueous humor, a transparent, jellylike fluid located in the anterior and posterior chamber of the eye. The compartment between the lens and retina is filled with the jellylike vitreous body. The pressure of both aqueous and vitreous humor, the so-called

intraocular pressure, is slightly elevated, keeping the eyeball spherical.

## Metabolic and Molecular Pathways and Processes in the Eye

### Production of Aqueous Humor

The aqueous humor is secreted into the posterior chamber of the eye by a part of the ciliary epithelium situated close to the region where the zonula fibers are attached (Fig. 1b). The composition of aqueous humor is relatively similar to blood plasma.

However, its protein concentration is low (less than 1 %), whereas ascorbate is up to 50 times higher than in blood plasma. Oxygen is derived

by diffusion from the cornea and from the vasculature of the iris [4]. The aqueous humor flows from the posterior chamber through the pupil into the anterior chamber (Fig. 1b) and drains away at the angle between the cornea and iris, where it passes through a porous tissue – the trabecular meshwork – into a collecting channel (Schlemm’s canal), which empties into veins and thus into the bloodstream. In the healthy eye, the delicate balance between aqueous fluid production, circulation, and drainage must be maintained in order to keep the intraocular pressure at a constant level. Slow drainage of aqueous humor or overproduction may lead to an increase in intraocular pressure that can result in the death of retinal ganglion cells – a disease called glaucoma (see chapter “[Glaucoma](#)”).

## Retinal Metabolism

The retina is inverse, i.e., before light reaches the photoreceptors, it has to pervade the different retinal layers: three layers of somata (termed ganglion cell layer, inner nuclear layer, and outer nuclear layer), separated by two synaptic layers (i.e., inner and outer plexiform layer). The ganglion cells are the output neurons of the retina. Their axons form the optic nerve (Fig. 1a). As all neurons, retinal cells conduct information by generating electrical signals at their plasma membrane (see chapter “[Overview](#)” under part “[Brain](#)”). Inside the cell, there is a high concentration of  $K^+$  ions and large polyanions (such as proteins and nucleic acids), while outside the  $Na^+$  ion concentration is high resulting in a resting membrane potential of  $-70$  mV.

Photoreceptor cells can be divided into two compartments (Fig. 2a). The inner compartment comprises the cell body, the axon with the synaptic region, as well as the biochemical machinery with the mitochondria and ribosomes for routine cell metabolism. The outer segment harbors all proteins to absorb light, to amplify the signal, and to generate an electrical signal in response to light.

Rod outer segments are effective light catchers. The outer segment of a human rod contains a stack of up to 800 flat, hollow membrane compartments,

called discs (Fig. 2b). The latter contain a high concentration of the photopigment rhodopsin in their membranes (Fig. 2c). Altogether 50–150 million rhodopsin molecules are found within a photoreceptor cell. Rhodopsin belongs to the family of G-protein-coupled receptors (see below). It consists of a protein part (the opsin) and a light-absorbing cofactor, the aldehyde form of vitamin A, retinal (Fig. 2c, d).

Retinal can exist in two different conformations. The folded 11-*cis*-retinal is covalently bound within the opsin molecule (Fig. 2c). Absorption of a light quantum causes 11-*cis*-retinal to switch to the elongated all-*trans*-retinal (Fig. 2d), inducing a conformational change in the rhodopsin molecule. This conformational change activates the G-protein transducin, which in turn activates phosphodiesterase 6 (PDE6). The latter hydrolyzes cGMP, which acts as a signal transducer, amplifier, and molecular switch. In the dark, due to an elevated cGMP concentration, cGMP-dependent ion channels (called cyclic nucleotide-gated ion channels) in the outer segments are open, leading to an influx of  $Na^+$  and  $Ca^{2+}$ , depolarization of the membrane potential, and transmitter release. Upon illumination and cGMP hydrolysis via PDE6, cGMP-dependent ion channels close. As fewer  $Na^+$  and  $Ca^{2+}$  enter the cell, the membrane potential becomes more negative. Thus, during illumination, the cells are more hyperpolarized, and fewer transmitter molecules are released from the synapse. This kind of membrane potential modulation, also termed graded potentials, controls the activity of photoreceptor cells, like that of most retinal cells. Graded potentials induce variations in the site of membrane potential in contrast to the “all-or-nothing” action potentials. To shut off the signaling cascade, rhodopsin becomes phosphorylated [5] and then sealed by arrestin, which ultimately stops the interaction with transducin.

The photoreceptor information is relayed synaptically via the bipolar cells to the ganglion cells. Along this path, lateral neuronal interactions and feedback loops are provided by horizontal cells in the outer and by amacrine cells in the inner plexiform layer. As retinal output neurons, ganglion cells communicate via action potentials – short

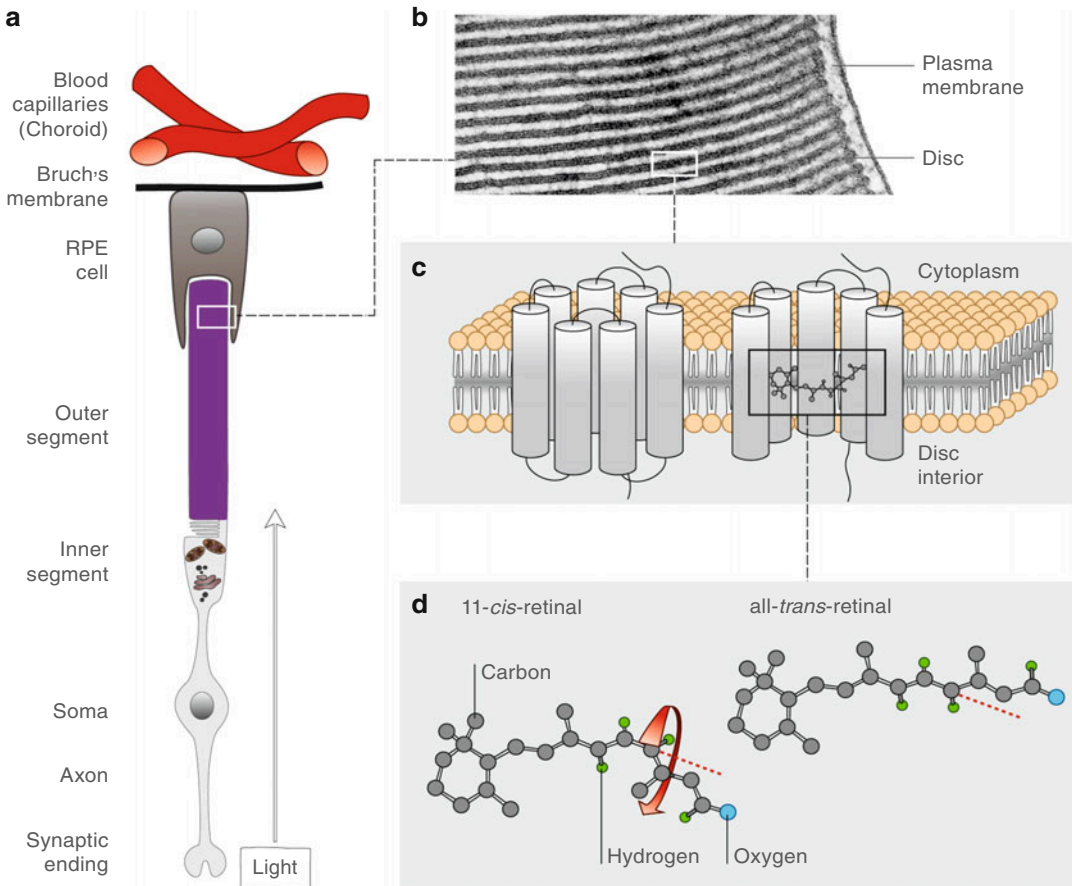

**Fig. 2** Rod photoreceptor and rhodopsin. **(a)** Schematic overview of a rod photoreceptor and its surrounding layers. The blood capillaries of the choroid provide nourishment and oxygen to the photoreceptors. The retinal pigment epithelium (*RPE*) cells fulfill many functions (e.g., retinal metabolism and blood-retinal barrier). Note that the center of the eye is towards the bottom. The outer segments of the photoreceptor cells contain light-absorbing discs. The inner segments contain cell body and normal metabolic machinery. **(b)** Shows an electron

micrograph of the region indicated in **(a)**, showing an outer segment of a photoreceptor cell with its membranous discs. **(c)** Schematic of a disc membrane harboring the light-sensitive pigment rhodopsin, a G-protein-coupled receptor with seven transmembrane helices (*left*). Two helices are removed to reveal the retinal-binding pocket (*right*). **(d)** Chemical structure of free 11-*cis*- and all-*trans*-retinal. Light converts 11-*cis*-retinal into all-*trans*-retinal

(1–2 ms) stereotyped changes in membrane potential that propagate in an all-or-none fashion along the axons of neurons (chapter “[Overview](#)” under part “[Brain](#)”).

The physiology of photoreceptors is extraordinary in the sense that a large ionic current in the dark is switched off in the light. Therefore, the energy consumption of the retina is four times higher in the dark than during illumination [6]. In the dark, about 50 % of the energy is used by the  $\text{Na}^+/\text{K}^+$ -ATPase to pump out excess  $\text{Na}^+$  that enter

the photoreceptors through open cGMP-dependent ion channels in the outer segment [7]. As during illumination the ion flux into the photoreceptor outer segment decreases, energy consumption by the  $\text{Na}^+/\text{K}^+$ -ATPase drops. However, the energy expenditure for the subsequent phosphorylation of rhodopsin and the regeneration of 11-*cis*-retinal increases.

Photoreceptor cells produce ATP from glucose mainly via oxidative phosphorylation and to a lesser extent via glycolysis [8], and thus large

mitochondria are found densely packed in the photoreceptor inner segments. Glucose and oxygen are supplied from the capillary network of the choroid that lies close to the photoreceptors (Figs. 1a and 2a). The oxygen consumption of the retina is appr. 20 % higher than the oxygen consumption reported for the brain [5].

## The Role of the Retinal Pigment Epithelium

Together with the retina, the RPE is among the most metabolically active tissues in the body. The RPE serves many functions. First, melanin in RPE cells absorbs light that has passed through the retina in order to prevent light scattering and to reduce light-induced damage. Second, the tight junctions between RPE cells form a barrier between the choroid and photoreceptors [9]. Analogous to the blood-brain barrier, this blood-retinal barrier controls exchange between blood and retina and thus maintains the specialized environment of the photoreceptors. The barrier function of the RPE is physically supported by Bruch's membrane that acts as a semipermeable molecular sieve [2]. At the same time, RPE cells utilize glucose transporters that allow passive transport of glucose from the choroid to the photoreceptors [10]. Third, the RPE is involved in the regeneration of 11-*cis*-retinal. All-*trans*-retinal (see above) detaches from the opsin and is enzymatically reduced to all-*trans*-retinol. Retinoid binding proteins shuttle the retinol from the outer segments to the RPE, where the rest of the retinal metabolism takes place. Here, all-*trans*-retinol is first esterized with palmitate, then isomerized to 11-*cis*-retinol, and finally, oxidized to 11-*cis*-retinal. The latter is transported back to the outer segment, where it spontaneously reacts with opsin to regenerate rhodopsin, thus completing the visual cycle.

Finally, the RPE is of utmost importance for the regeneration of the photoreceptor outer segments. The strong illumination of the outer segments in a high-oxygen environment can lead to photochemical damage. If the energy from a photon is transferred from a light-absorbing

molecule to oxygen, reactive oxygen species (e.g., singlet oxygen) can be created. Those can break molecular bonds or induce photooxidation. Accumulation of such events can ultimately lead to damage of the outer segments. Therefore, photoreceptor outer segments must be constantly renewed. Around sunrise, the tips of the outer segments are shed off and are phagocytosed by RPE cells, while new discs are added at the bases of the outer segments [11]. Complete renewal of the rod outer segment takes approximately 10 days. Due to the high amount of material, phagocytosis in RPE cells is metabolically demanding. Some of the breakdown products may be recycled, while others are discharged into the choriocapillaries. Some undigested proteins, lipids, and retinoids remain as an aggregation complex called lipofuscin [9]. Chemical reactions between these components lead to the formation of retinoid-lipid complexes in lipofuscin, the so-called bisretinoids [12]. Lipofuscin can absorb light, shows autofluorescence, and is susceptible to photochemical changes. Lipofuscin accumulation is thought to contribute to the development of age-related macular degeneration (see chapter "[Age-related macular degeneration](#)").

---

## Inside-Out: Signals from the Eye Affecting Other Organs and Tissues

The impact of the eye on other organs results mainly from the projection of the retinal output neurons, the ganglion cells, which relay the signals from the retina via their axons to the brain. Most of the ganglion cell output provides the basis for visual information processing that involves at least 30 % of the cerebral cortex.

Recently, a class of ganglion cells has been described that serves an entirely different function. These ganglion cells express their own photopigment called melanopsin, which is distantly related to rhodopsin. This cell class provides input to the suprachiasmatic nucleus (SCN) in the brain (together forming the retinohypothalamic tract). The SCN functions as pacemaker, responsible for the generation of the circadian clock. Retinal input from the melanopsin-containing ganglion cells

resets the clock in the SCN every day [13]. SCN cells project to the paraventricular nucleus of the hypothalamus – a site of hormone production. The projection from the SCN to the pineal gland controls the release of melatonin, the “hormone of the night” that is involved in the regulation of our sleep-wake cycle. Circadian rhythms also influence body temperature, blood pressure, and heart frequency (see chapters “[Migraine and cluster headache](#)” and “[Rheumatoid arthritis](#)”).

---

### Outside-In: Signals and Metabolites Affecting the Function of the Eye

Vitamin A, the precursor of retinal, is an essential vitamin [14]. It is stored in the liver (see chapter “[Overview](#)” under part “Liver”) and transported in the blood (see chapter “[Overview](#)” under part “Blood”) by retinoid binding proteins. RPE cells absorb vitamin A from the choroidal circulation and convert it to retinal to supply the photoreceptors. As retinal is pivotal for rhodopsin function, lack of vitamin A may lead to night blindness.

Diabetes (see chapter “[Diabetes mellitus](#)”) can affect the performance of the eye in two major ways. First, in the lens, glucose can be converted into sorbitol, which is later – but more slowly – converted into fructose [15]. Under normal conditions, only small amounts of sorbitol are synthesized. However, unphysiologically high blood glucose levels cause excess sorbitol production, which results in osmotic swelling of the lens (as sorbitol and fructose cannot leave the lens and thus are highly osmotic) that can ultimately lead to lens clouding, i.e., cataract. Second, diabetes triggers pathological changes in retinal blood vessels. In early diabetic retinopathy (the so-called non-proliferative stage), retinal blood vessels become blocked, which results in reduced nourishment and oxygen supply. In response to the hypoxic state, in a second phase (called proliferative diabetic retinopathy), new blood vessels are formed. These vessels are thinner, mechanically less stable and their endothelial cells form a less effective blood-retinal

barrier. Consequences are bleedings into the retina and vitreous as well as scar formation and detachment of the retina. Diabetic retinopathy may ultimately lead to blindness.

---

### Final Remarks

The main functions of the eye are to provide visual information about our environment and to synchronize our internal clock to the day/night cycle. Partial or total blindness can be induced by several mechanisms, including the destruction of retinal ganglion cells and optic nerve due to an increase in intraocular pressure, as in glaucoma (see chapter “[Glaucoma](#)”), or the loss of photoreceptor cells triggered by photochemical damage or other factors, such as in age-related macular degeneration (see chapter “[Age-related macular degeneration](#)”).

---

### References

1. Masland R (2012) The neuronal organization of the retina. *Neuron* 76:266–280
2. Booi JC, Baas DC, Beisekeeva J, Gorgels TG, Bergen AA (2010) The dynamic nature of Bruch’s membrane. *Prog Retin Eye Res* 29:1–18
3. Hunter JJ, Morgan JJ, Merigan WH, Sliney DH, Sparrow JR, Williams DR (2012) The susceptibility of the retina to photochemical damage from visible light. *Prog Retin Eye Res* 31:28–42
4. Shui YB, Fu JJ, Garcia C, Dattilo LK, Rajagopal R, McMillan S, Mak G, Holekamp NM, Lewis A, Beebe DC (2006) Oxygen distribution in the rabbit eye and oxygen consumption by the lens. *Invest Ophthalmol Vis Sci* 47:1571–1580
5. Yau KW, Hardie R (2009) Phototransduction motifs and variations. *Cell* 139:246–264
6. Okawa H, Sampath AP, Laughlin SB, Fain GL (2008) ATP consumption by mammalian rod photoreceptors in darkness and in light. *Curr Biol* 18:1917–1921
7. Ames A 3rd, Li YY, Heher EC, Kimble CR (1992) Energy metabolism of rabbit retina as related to function: high cost of Na<sup>+</sup> transport. *J Neurosci* 12:840–853
8. Wong-Riley M (2010) Energy metabolism of the visual system. *Eye Brain* 2:99–116
9. Cunha-Vaz JG (1976) The blood-retinal barriers. *Doc Ophthalmol* 41:287–327

10. Senanayake P, Calabro A, Hu JG, Bonilha VL, Darr A, Bok D, Hollyfield JG (2006) Glucose utilization by the retinal pigment epithelium: evidence for rapid uptake and storage in glycogen, followed by glycogen utilization. *Exp Eye Res* 83:235–246
11. Kevany BM, Palczewski K (2010) Phagocytosis of retinal rod and cone retinal. *Physiology (Bethesda)* 25:8–15
12. Keller JN, Dimayuga E, Chen Q, Thorpe J, Gee J, Ding Q (2004) Autophagy, proteasomes, lipofuscin, and oxidative stress in the aging brain. *Int J Biochem Cell Biol* 36:2376–2391
13. Berson D (2003) Strange vision: ganglion cells as circadian photoreceptors. *Trends Neurosci* 26:314–320
14. D'Ambrosio DN, Clugston RD, Blaner WS (2011) Vitamin A metabolism: an update. *Nutrients* 3: 63–103
15. Kinoshita JH (1965) Pathways of glucose metabolism in the lens. *Invest Ophthalmol* 4:619–628

---

# Age-Related Macular Degeneration

Monika Fleckenstein and Frank G. Holz

---

## Introduction to Age-Related Macular Degeneration

Age-related macular degeneration (AMD) is the leading cause of irreversible blindness in the elderly population of industrialized countries [1]. Based on a meta-analysis, the prevalence of early-stage AMD is estimated to be 6.8 % and for the late stages 1.5 % [2]. Prevalence, incidence, and progression of all forms of AMD rise with increasing age. Thirty percent of all probands aged 75 years were found to have early AMD and 7.1 % suffered from late stages of the disease [3, 4].

Various cell layers are involved in the disease process: the choriocapillaris (i.e., the layer of capillaries adjacent to Bruch's membrane in the choroid), Bruch's membrane, the retinal pigment epithelium (RPE), and photoreceptors (see chapter "Overview" under part "Eye"). AMD typically affects the central retina (macula including the fovea) as the area with the highest resolution. Untreated, the disease results in severe loss of vision.

Different stages and phenotypic manifestations of the disease have been categorized [5]. The early and intermediate dry forms of the disease are characterized by the so-called drusen and pigmentary alterations. Drusen are extracellular deposits located within Bruch's membrane

under the RPE. The late stages of AMD are subdivided into an exudative and a non-exudative form. The exudative form is characterized by the formation of choroidal neovascularizations (CNV) with concomitant extracellular fluid accumulation, RPE detachment, and/or hemorrhages. The non-exudative late stage, termed "geographic atrophy" (GA), is characterized by cell death of all affected cell layers. It has been speculated that GA is the natural end stage of AMD, if the disease does not convert into CNV [6]. The exudative and non-exudative forms are not mutually exclusive, as these may develop in the same eye.

---

## Pathophysiology of Age-Related Macular Degeneration and Metabolic Alterations

The pathogenesis of AMD is incompletely understood. As a complex, multifactorial disease, it is thought to be affected by numerous systemic, genetic, and environmental factors, e.g., smoking.

Aging processes appear to play a major role in the pathogenesis of AMD, and it is presumed that everybody would develop AMD if only a high enough age would be reached.

During AMD, changes in Bruch's membrane are observed and accompanied by activation of the complement system. Deposition of molecules within Bruch's membrane leads to formation of drusen, a characteristic of early- and late-stage AMD. Accumulation of lipofuscin and reactive

---

M. Fleckenstein • F.G. Holz (✉)  
Department of Ophthalmology, University of Bonn,  
Ernst-Abbe-Straße 2, 53127 Bonn, Germany  
e-mail: [monika.fleckenstein@ukb.uni-bonn.de](mailto:monika.fleckenstein@ukb.uni-bonn.de);  
[frank.holz@ukb.uni-bonn.de](mailto:frank.holz@ukb.uni-bonn.de)



oxygen species (ROS) damage the RPE and likewise contribute to the progression of AMD.

Considerable structural changes in Bruch's membrane occur due to aging processes [7]. As a result of calcification, loss of its elastin layer, and formation of cross-links such as advanced glycation end products (AGEs), the membrane becomes more brittle. Furthermore, it increases in thickness due to the lifelong entrapment of molecules and cellular debris, particularly lipids. These accumulations of proteins and lipids are called drusen. Structural changes and accumulation of material within Bruch's membrane may reduce the free flow of molecules between the choroid and the photoreceptors and, eventually, in the most severe cases, lead to cellular atrophy.

Altered immune responses with complement system activation are thought to be further involved in AMD [8], as complement proteins are found within the drusen, and contain rise allows of complement jensen are associater with the disease. The complement system belongs to the innate immune system (see chapter "Overview" under part "Immune system") and can be activated via three different pathways, i.e., the classic, lectin, and alternative ones. Whereas the classical and lectin pathways are activated via antibodies and opsonins, respectively, which are bound to the surface of a pathogen, the alternative complement pathway is continuously active at a low level and becomes activated by the absence of complement regulatory proteins on the surface of most microbial pathogens. In each pathway, a proteolytic cascade is amplified, and effectors such as anaphylatoxins, the membrane attack complex, and opsonins may be activated. It has been suggested that aging causes an increased activation of the alternative complement system in the blood [9]. The role of the alternative complement pathway in AMD pathogenesis has been exemplified by the discovery of the gene for complement factor H (CFH) [10–12], an inhibitor of the alternative pathway, as well as other risk loci in this pathway [13–15]. Specific polymorphisms in these genes are thought to be associated with abnormal complement activation [16].

Furthermore, the retina provides an ideal environment for the generation of ROS due to its specific anatomical and metabolic characteristics

[17], such as (1) high oxygen consumption by the retina and RPE compared to many other tissues, (2) high levels of cumulative irradiation, and (3) abundance of photosensitizers within the neurosensory retina and RPE. Furthermore, photoreceptor outer segment membranes are rich in polyunsaturated fatty acids, which are readily oxidized and thus can initiate a cytotoxic chain reaction.

Accumulation of lipofuscin granules in post-mitotic RPE cells apparently due to incomplete lysosomal degradation of photoreceptor outer segments further contributes to AMD progression [7]. Lipofuscin is a photosensitizer generating a range of ROS. Furthermore, the photoreactivity of individual lipofuscin granules increases with age. Exposure of lipofuscin-containing RPE cells to blue light results in lipofuscin-dependent lipid peroxidation, protein oxidation, loss of lysosomal integrity, mitochondrial DNA damage, and retinal pigment epithelium (RPE) cell death (Fig. 1).

The interaction of these metabolic and structural alterations with genetic and environmental risk factors is thought to induce pathological changes promoting the development of phenotypic AMD changes and resulting in an earlier onset of the disease. They also form the basis for therapeutic rationales, e.g., targeting oxidative stress with prophylactic and interventional pharmacological measures (see below).

In exudative AMD, vascular endothelial growth factor-A (VEGF-A, or VEGF, in brief) has been identified as a major factor inducing ocular neovascularizations [18]. Further, VEGF plays a role in inflammatory processes, immunity, and wound healing; it acts as a survival factor for endothelial cells and as a neuroprotectant for neurons in the central nervous system and the retina. The angiogenic cascade and vascular permeability induced by VEGF [18] play an essential role in the therapeutic concept of VEGF inhibition (Fig. 2).

---

## Treatment of Age-Related Macular Degeneration

So far, a number of different approaches have been tried to prevent the development of the late stages of AMD. However, with the exception of small effects of dietary supplements, efficacious



**Fig. 1** Lipofuscin-dependent reactive oxygen species (ROS) generation – a metabolic pathway presumed to contribute to the age-related macular degeneration (AMD) disease process. *POS* photoreceptor outer segments, *RPE* retinal pigment epithelium

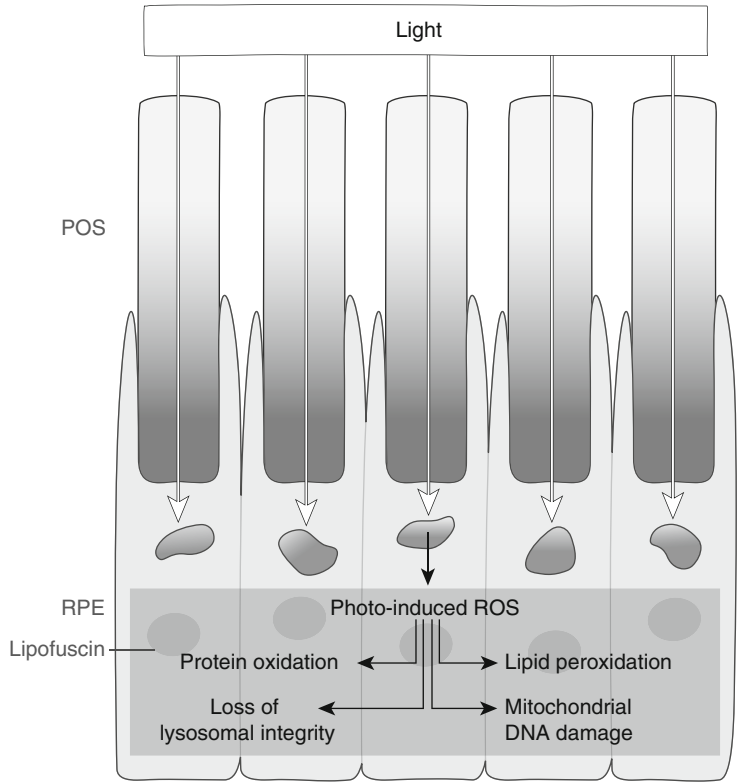

**Fig. 2** Anti-vascular endothelial growth factor-A (VEGF-A) strategies currently used in the treatment of exudative age-related macular degeneration (AMD). The angiogenic cascade and vascular permeability [18] play an essential role in VEGF inhibition. *IgG* immunoglobulin G

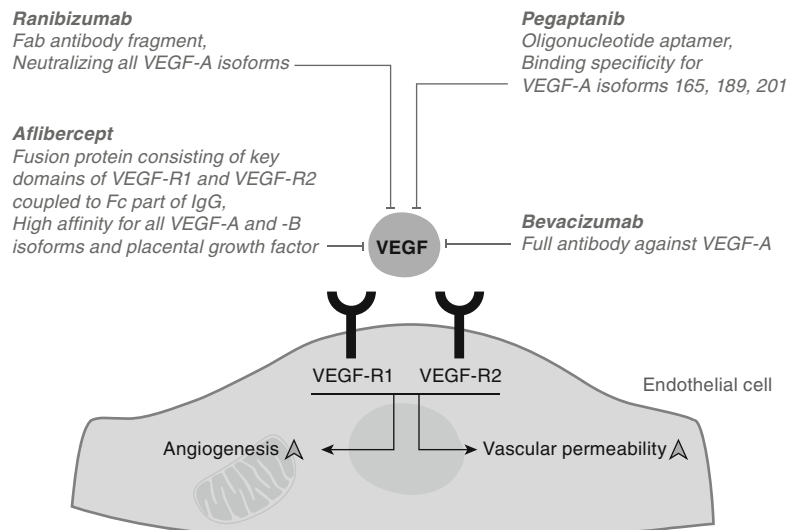

measures are currently lacking. Only recently it has been achieved to treat exudative AMD successfully using anti-VEGF compounds injected into the vitreous at regular intervals. In clinical practice, this treatment strategy for exudative AMD has replaced angio-occlusive therapies such as laser photocoagulation and verteporfin photodynamic therapy.

For the non-exudative late stage of AMD, there is no treatment available yet to slow or to halt GA progression. A number of preclinical and clinical trials are currently carried out to find a treatment for this form of AMD manifestation.

---

## **Influence of Treatment on Metabolism**

### **Nutritional Supplementation to Prevent Development of Late-Stage AMD**

Alleviation of oxidative stress is thought to be a critical step to prevent the conversion from early to late AMD stages. Nutrients that may reduce oxidative damage include vitamins, carotenoids, and trace elements. The AREDS (Age-Related Eye Disease Study) trial demonstrated that a combination of vitamins C and E,  $\beta$ -carotene, and zinc oxide, reduces the risk of late-stage AMD in patients with intermediate risk of conversion [19]. A recent update suggested lutein and zeaxanthin as appropriate substitutes for  $\beta$ -carotene, which increased the incidence of lung cancer in former smokers [20]. Due to their high number of double bonds, these macular carotenoids/pigments can quench ROS, limiting oxidative stress, increasing membrane stability, and may also act as filters for blue light and thus limit retinal photo-stress [21].

### **Anti-VEGF Therapy in the Treatment of Exudative AMD**

Pegaptanib, the first approved intravitreally injected anti-VEGF medication, is an oligonucleotide aptamer with a high binding specificity for the VEGF-A isoforms 165, 189, and 201. An important basis for the development of pegap-

tanib sodium was the results of studies showing that VEGF-A-165 plays an important role in the neovascularization process [22]. The complete blockage of all VEGF-A isoforms was thought to impair physiological functions [23]. Efficacy of pegaptanib in clinical studies was limited.

Ranibizumab is a Fab antibody fragment neutralizing all VEGF-A isoforms. It is well tolerated and shows a favorable safety profile. Monthly injected ranibizumab has been shown to stabilize or to improve vision in over 90 % of patients and significantly improve vision in over 30 % of patients [24–26].

Aflibercept is a fusion protein, consisting of the key domains of the human VEGF receptors 1 and 2, coupled to the Fc part of a human IgG molecule. It has a high affinity for all VEGF-A and VEGF-B isoforms as well as placental growth factor [27], and theoretical models as well as trials [28] indicate a longer duration of action compared with current treatments. In the studies with intravitreal aflibercept, no increase in ocular or systemic adverse events was noted, despite the increased affinity of aflibercept for all VEGF-A and VEGF-B isoforms [28].

Bevacizumab, a full antibody against VEGF-A, has originally been developed as a cancer therapeutic. It is also used for the intravitreal treatment of exudative AMD. However, the drug has not been approved for this indication and, therefore, represents an off-label therapy.

Intravenous administration of anti-VEGF compounds in the treatment of cancer has been associated with increased risks of stroke (see chapter “Stroke”), venous thromboembolism, congestive heart failure, and bleeding. However, results across studies with differing methodologies provide some reassurance that the widespread use of injections of VEGF inhibitors within the vitreous to treat exudative AMD has not resulted in significant increases of systemic adverse events [29].

---

## **Perspectives**

The treatment of AMD will be one of the major challenges in health care during the next decades. In particular, primary prevention of AMD as well

as prevention of progression from early to late AMD stages represent an unmet need and are, therefore, in the focus of current research activities. While anti-VEGF therapy represents a breakthrough in the therapy of neovascular AMD, repeated, sometimes lifelong, administration of the drug is an enormous burden for the patients and health systems. Long-acting drug delivery systems would therefore be desirable.

As of yet, there is no treatment available to slow or to halt progression of the dry late form of AMD, i.e., GA. However, various preclinical and clinical trials are currently ongoing. Targets for this phenotype address various pathways including inflammation, complement system, trophic factors, oxidative stress, reduction of retinal toxins, and improvement of choroidal blood flow [30].

## References

- Lim LS, Mitchell P, Seddon JM, Holz FG, Wong TY (2012) Age-related macular degeneration. *Lancet* 379:1728–1738
- Smith W, Assink J, Klein R, Mitchell P, Klaver CC, Klein BE, Hofman A, Jensen S, Wang JJ, de Jong PT (2001) Risk factors for age-related macular degeneration: Pooled findings from three continents. *Ophthalmology* 108:697–704
- Klein R, Klein BE, Linton KL (1992) Prevalence of age-related maculopathy. The Beaver Dam Eye Study. *Ophthalmology* 99:933–943
- Klein R, Klein BE, Jensen SC, Meuer SM (1997) The five-year incidence and progression of age-related maculopathy: the Beaver Dam Eye Study. *Ophthalmology* 104:7–21
- Ferris FL 3rd, Wilkinson CP, Bird A, Chakravarthy U, Chew E, Csaky K, Sadda SR (2013) Clinical classification of age-related macular degeneration. *Ophthalmology* 120:844–851
- Sarks SH (1976) Ageing and degeneration in the macular region: a clinico-pathological study. *Br J Ophthalmol* 60:324–341
- Boulton M (2013) Ageing of the retina and retinal pigment epithelium. In: Holz FG, Pauleikhoff D, Spaide RF, Bird AC (eds) *Age-related macular degeneration*. Springer, Heidelberg/New York/Dordrecht/London, pp 45–63
- Hageman GS, Luthert PJ, Victor Chong NH, Johnson LV, Anderson DH, Mullins RF (2001) An integrated hypothesis that considers drusen as biomarkers of immune-mediated processes at the RPE-Bruch's membrane interface in aging and age-related macular degeneration. *Prog Retin Eye Res* 20:705–732
- Hecker LA, Edwards AO, Ryu E, Tosakulwong N, Baratz KH, Brown WL, Charbel Issa P, Scholl HP, Pollok-Kopp B, Schmid-Kubista KE, Bailey KR, Oppermann M (2010) Genetic control of the alternative pathway of complement in humans and age-related macular degeneration. *Hum Mol Genet* 19:209–215
- Haines JL, Hauser MA, Schmidt S, Scott WK, Olson LM, Gallins P, Spencer KL, Kwan SY, Noureddine M, Gilbert JR, Schnetz-Boutaud N, Agarwal A, Postel EA, Pericak-Vance MA (2005) Complement factor H variant increases the risk of age-related macular degeneration. *Science* 308:419–421
- Klein RJ, Zeiss C, Chew EY, Tsai JY, Sackler RS, Haynes C, Henning AK, SanGiovanni JP, Mane SM, Mayne ST, Bracken MB, Ferris FL, Ott J, Barnstable C, Hoh J (2005) Complement factor H polymorphism in age-related macular degeneration. *Science* 308:385–389
- Edwards AO, Ritter R 3rd, Abel KJ, Manning A, Panhuysen C, Farrer LA (2005) Complement factor H polymorphism and age-related macular degeneration. *Science* 308:421–424
- Maller J, George S, Purcell S, Fagerness J, Altshuler D, Daly MJ, Seddon MJ (2006) Common variation in three genes, including a noncoding variant in CFH, strongly influences risk of age-related macular degeneration. *Nat Genet* 38:1055–1059
- Gold B, Merriam JE, Zernant J, Hancox LS, Taiber AJ, Gehrs K, Cramer K, Neel J, Bergeron J, Barile GR, Smith RT, AMD Genetics Clinical Study Group, Hageman GS, Dean M, Allikmets R (2006) Variation in factor B (BF) and complement component 2 (C2) genes is associated with age-related macular degeneration. *Nat Genet* 38:458–462
- Maller JB, Fagerness JA, Reynolds RC, Neale BM, Daly MJ, Seddon JM (2007) Variation in complement factor 3 is associated with risk of age-related macular degeneration. *Nat Genet* 39:1200–1201
- Nitsch D, Douglas I, Smeeth L, Fletcher A (2008) Age-related macular degeneration and complement activation-related diseases: a population-based case-control study. *Ophthalmology* 115:1904–1910
- Beatty S, Koh H, Phil M, Henson D, Boulton M (2000) The role of oxidative stress in the pathogenesis of age-related macular degeneration. *Surv Ophthalmol* 45:115–134
- Grisanti S, Lüke J, Peters S (2013) Anti-VEGF therapy: basics and substances. In: Holz FG, Pauleikhoff P, Spaide RF, Bird AC (eds) *Age-related macular degeneration*. Springer, Heidelberg/New York/Dordrecht/London, pp 225–232
- Age-Related Eye Disease Study Research Group (2001) A randomized, placebo-controlled, clinical trial of high-dose supplementation with vitamins C and E, beta carotene, and zinc for age-related macular degeneration and vision loss: AREDS report no. 8. *Arch Ophthalmol* 119:1417–1436
- Chew EY, Clemons TE, Agrón E, Sperduto RD, Sangiovanni JP, Kurinij N, Davis MD (2013) Long-term effects of vitamins C and E, beta-carotene, and

- zinc on age-related macular degeneration: AREDS report no. 35. *Ophthalmology* 120:1604–1611
21. Loane E, Kelliher C, Beatty S, Nolan JM (2008) The rationale and evidence base for a protective role of macular pigment in age-related maculopathy. *Br J Ophthalmol* 92:1163–1168
  22. Ishida S, Usui T, Yamashiro K, Kaji Y, Amano S, Ogura Y, Hida T, Oguchi Y, Ambati J, Miller JW, Gragoudas ES, Ng YS, D'Amore PA, Shima DT, Adamis AP (2003) VEGF164-mediated inflammation is required for pathological, but not physiological, ischemia-induced retinal neovascularization. *J Exp Med* 198:483–489
  23. Usui T, Ishida S, Yamashiro K, Kaji Y, Poulaki V, Moore J, Moore T, Amano S, Horikawa Y, Dartt D, Golding M, Shima DT, Adamis AP (2004) VEGF164(165) as the pathological isoform: differential leukocyte and endothelial responses through VEGFR1 and VEGFR2. *Invest Ophthalmol Vis Sci* 45:368–374
  24. Rosenfeld PJ, Brown DM, Heier JS, Boyer DS, Kaiser PK, Chung CY, Kim RY (2006) Ranibizumab for neovascular age-related macular degeneration. *N Engl J Med* 355:1419–1431
  25. Brown DM, Kaiser PK, Michels M, Soubrane G, Heier JS, Kim RY, Sy JP, Schneider S (2006) Ranibizumab versus verteporfin for neovascular age-related macular degeneration. *N Engl J Med* 355:1432–1444
  26. Mitchell P, Foran S (2013) Anti-VEGF therapy for AMD: results and guidelines. In: Holz FGP, Pauleikhoff D, Spaide RF, Bird AC (eds) *Age-related macular degeneration*. Springer, Heidelberg/New York/Dordrecht/London
  27. Ohr M, Kaiser PK (2012) Aflibercept in wet age-related macular degeneration: a perspective review. *Ther Adv Chronic Dis* 3:153–161
  28. Heier JS, Brown DM, Chong V, Korobelnik JF, Kaiser PK, Nguyen QD, Kirchhof B, Ho A, Ogura Y, Yancopoulos GD, Stahl N, Vitti R, Berliner AJ, Soo Y, Anderesi M, Groetzsch G, Sommerauer B, Sandbrink R, Simader C, Schmidt-Erfurth U (2012) Intravitreal aflibercept (VEGF trap-eye) in wet age-related macular degeneration. *Ophthalmology* 119:2537–2548
  29. Campbell RJ, Bell CM, Campbell Ede L, Gill SS (2013) Systemic effects of intravitreal vascular endothelial growth factor inhibitors. *Curr Opin Ophthalmol* 24:197–204
  30. Mata NL, Vogel R (2010) Pharmacologic treatment of atrophic age-related macular degeneration. *Curr Opin Ophthalmol* 21:190–196

---

# Glaucoma

Samuel D. Crish and Christine M. Dengler-Crish

---

## Introduction to Glaucoma

The term “glaucoma” includes a number of optic neuropathies that share certain commonalities. Together they make up the leading cause of irreversible blindness worldwide, estimated to affect 80 million people by 2020 [1]. Primarily, these neuropathies are characterized by a progressive vision loss due to dysfunction and degeneration of retinal ganglion cells in the eye [1]. Most glaucomas have a genetic component where family history and ethnicity increase its likelihood, e.g., African-Americans are up to eight times as likely to develop glaucoma—and at an earlier age—than their Caucasian counterparts. Most glaucomas are age related, with sharp increases in the incidence of glaucoma occurring after age 60. Thus, age poses the primary overall risk factor for glaucoma. Elevated intraocular pressure (IOP), however, is the primary modifiable risk factor [2].

Glaucoma can be subdivided into two main types: open-angle and closed-angle glaucoma. The distinctions between them are the morphology of the angle between the iris and cornea (the iridocorneal angle)—the location where aqueous humor (AH) drains out of the anterior chamber (see chapter “[Overview](#)” under part “[Eye](#)”)—and the speed of pathological progression. Open-angle

glaucoma, where the angle appears normal, is the most common type, comprising 90 % of diagnosed glaucomas [3]. It is a slow, progressive clogging of the angle between the iris and cornea. Symptoms may not be noticed and it can take decades until blindness occurs. Closed-angle glaucoma is caused by blockade of drainage canals due to a narrowing of the iridocorneal angle. It is an acute disorder—evident to the patient right away and requiring immediate medical attention as damage occurs rapidly. Within each of these types there are variants depending on the specific causes or characteristics of each. Some examples of these variants include pigmentary glaucoma (where degeneration of the iris causes blockade of the iridocorneal angle), traumatic glaucoma (where glaucoma develops due to eye trauma), and juvenile glaucoma (caused by abnormal development of drainage canals in the eye).

The interactions between IOP and age in the development of glaucoma are complex. A significant proportion of glaucomatous vision loss occurs in the absence of elevated IOP (called “normal-tension glaucoma”), and most people with high IOP never develop glaucoma [4].

Within the retina, interrelated mechanisms common to other neurodegenerative conditions such as oxidative stress, calcium dysregulation, hemodynamic changes, metabolic defects, intracellular transport deficits, gliosis, and neuroinflammation have been suggested to play a role in the pathogenesis and progression of glaucomatous pathology [5]. These disturbances result in functional deficits in neuronal signaling, intracellular

---

S.D. Crish (✉) • C.M. Dengler-Crish  
Department of Pharmaceutical Sciences,  
Northeast Ohio Medical University,  
4209 SR 44, 95, Rootstown, OH 44272, USA  
e-mail: [scrish@neomed.edu](mailto:scrish@neomed.edu); [ccrish@neomed.edu](mailto:ccrish@neomed.edu)

transport in the retinal ganglion cells, as well as degeneration of neuronal processes resulting in apoptotic cell death. To date, the mechanisms underlying these changes are not well understood.

---

## Pathophysiology of Glaucoma and Metabolic Alterations

An association between glaucoma and metabolic conditions has long been postulated and debated. Early studies have shown an increased prevalence of acute closed-angle glaucoma among patients with metabolic disorders, such as homocystinuria, and Lowe's syndrome [6]. However, the focus of most research in this area has been on the putative relationship between glaucoma and diabetes mellitus (see chapter "[Diabetes mellitus](#)")—and whether each of the respective conditions serves as a risk factor for the other. While diabetic retinopathies are well described, the reasons for the increased incidence of glaucoma in diabetic patients are poorly understood [7].

Closed-angle glaucoma is likely associated with diabetes since abnormal glucose responses, shallow anterior chambers of the eye, and dysfunction of the autonomic nervous system seem to be related. Open-angle glaucoma is even more widely studied but also less understood [8]. Interestingly, obesity [9], hypertension [8], and insulin resistance (symptoms of metabolic syndrome, see chapter "[Metabolic syndrome](#)") have a stronger relationship to increased IOP than diabetes itself [10]. This could be explained by several factors (Fig. 1). Fat deposits around the eye and blood viscosity are often increased among obese individuals—the latter being due to elevated levels of hematocrit, lipids, fibrinogen, and immunoglobulins as well as changes in red blood cell rigidity [11]. Both fat deposits and high blood viscosity can increase resistance of the episcleral vein, which in turn impedes AH outflow [12]. The accumulation of AH in an environment that restricts its exit can ultimately lead to a net increase in IOP [13].

While the mechanisms are less clear, insulin resistance and associated elevated blood glucose are suggested to alter the osmotic gradient to

cause fluid accumulation in the intraocular space, thus increasing IOP [12].

Systemic hypertension increases ciliary capillary pressure and can increase AH filtration through the ciliary body of the eye [14]. In a mechanism similar to that described for fat deposits and blood viscosity, increased blood volume associated with elevated systemic blood pressure can increase episcleral and ciliary vein resistance [15]. This resistance opposes flow through the drainage canals and ultimately increases IOP [16]. However, other studies have associated low blood pressure with increased likelihood of developing glaucoma [17]. In this case, reduced ocular perfusion pressure (the difference between IOP and systemic blood pressure—opposing pressures that determine blood flow to optic tissues) results in decreased blood flow to the retina or optic nerve head [17]. As the retina is one of the most metabolically demanding tissues in the body, even relatively subtle declines in oxygen and nutrient supply may directly blunt retinal function and/or raise vulnerability to insult through increased oxidative stress, calcium dysregulation, and abnormal neuronal signaling [5].

---

## Treatment of Glaucoma

Although the dysfunction and degeneration of retinal ganglion cells and their projections are what cause blindness in glaucoma, existing therapies target lowering IOP through medication or surgery [18]. Currently, first-line treatment for glaucoma is the topical use of eyedrops to reduce IOP [19]. There are five main classes of IOP-lowering drugs, all of which either reduce the production of AH (by reducing activity of the ciliary body) or increase AH outflow (by action on the drainage canals in the iridocorneal angle, Table 1). Interestingly, lowering IOP often slows the progression of vision loss even in patients with normal IOP [20].

AH production can be reduced with drugs targeting the adrenergic system, antagonizing  $\beta$ - and activating  $\alpha$ -receptors (e.g., timolol or brimonidine, respectively), or with carbonic anhydrase inhibitors (e.g., dorzolamide), presumably by slowing the formation of bicarbonate ions with subsequent reduction in  $\text{Na}^+$  and fluid transport.

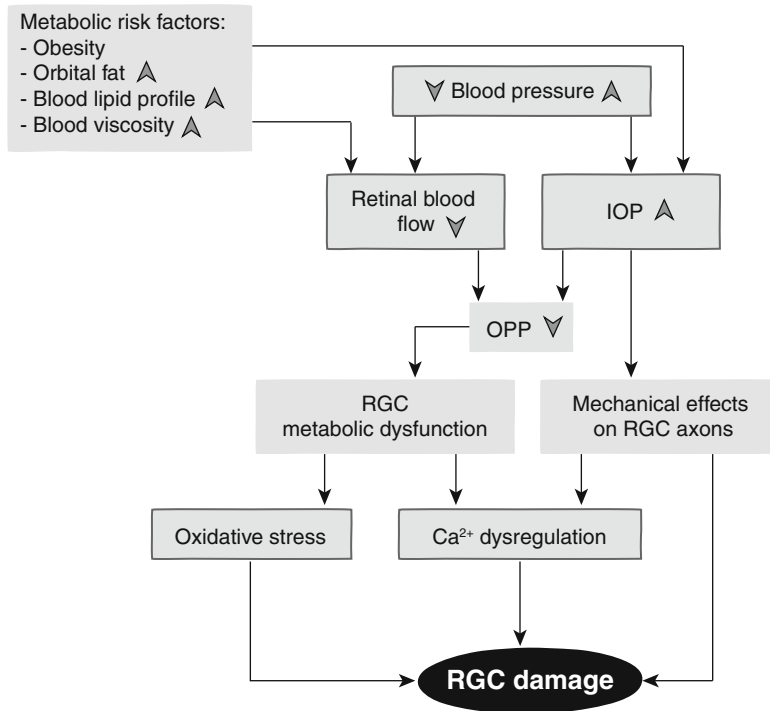

**Fig. 1** Relationship between conditions associated with metabolic syndrome, diabetes, and glaucoma. Different factors act to (1) increase intraocular pressure (*IOP*) or (2) reduce blood flow to the retina (due to either low blood pressure or microvascular changes). Either of these effects will reduce ocular perfusion pressure (*OPP*), leading to a decrease in retinal blood supply. Ultimately, this impairs

retinal function and leads to retinal ganglion cell (*RGC*) damage and degeneration through specific ( $Ca^{2+}$ -activated degenerative cascades) and nonspecific (oxidative stress-induced damage) mechanisms. Another major factor in glaucoma is age. Terms highlighted in framed boxes change with age in a way that age increases the prevalence and severity of the disease

**Table 1** Classes and examples of the most important glaucoma treatments

Drug class	Examples	AH production	AH outflow
Prostaglandin analogs	Latanoprost, travoprost		▲
β-Blockers	Timolol, carteolol	▼	
α-Agonists	Brimonidine, apraclonidine	▼	▲
Carbonic anhydrase inhibitors	Dorzolamide, brinzolamide	▼	
Cholinergic agonists	Pilocarpine, carbachol		▲

AH aqueous humor

Alternatively, AH outflow can be increased by prostaglandin analogs (e.g., latanoprost, a prostaglandin F analog) or agonists of adrenergic and cholinergic signaling (e.g., carbachol).

Patients who are unresponsive to these medications or have other issues can undergo surgery to physically increase AH outflow by creating new drainage canals in the eye. Shunts or cannulae used as drainage devices may also be implanted.

### Influence of Treatment on Metabolism

Pharmacological treatment of glaucoma typically does not affect systemic metabolism to a large degree. The most common side effects impact the eye itself and may include irritation or discomfort due to corneal dryness, inflammation, or allergic reaction. However, some of the topical drugs

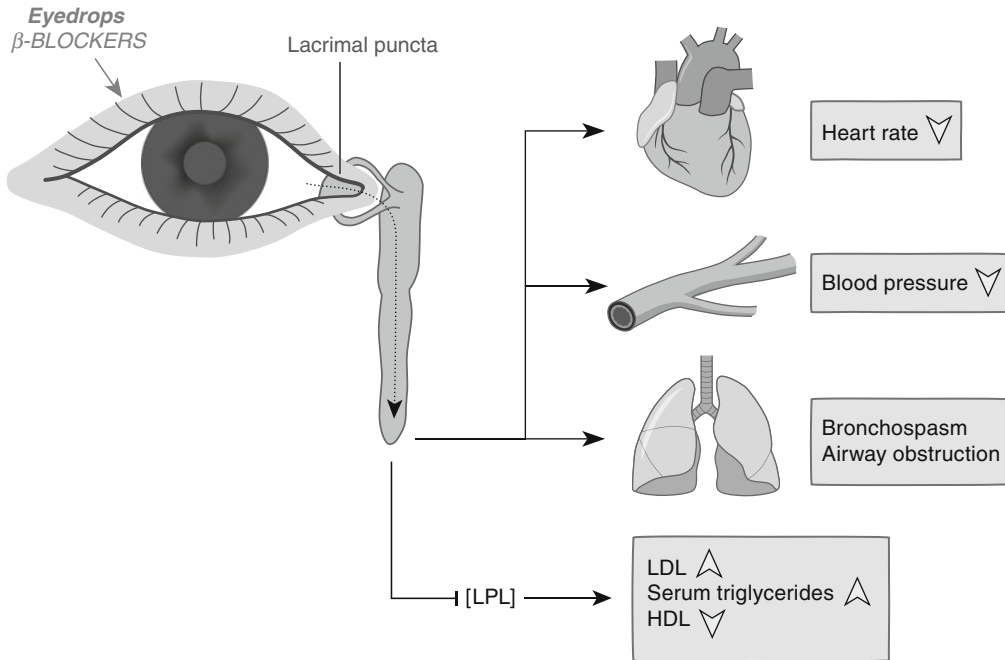

**Fig. 2** Effects of topical  $\beta$ -blocker treatment (eyedrops) on systemic function. Eyedrops travel through the lacrimal puncta and enter systemic circulation through the nasolacrimal duct. Common intraocular pressure-lowering drugs that inhibit the adrenergic system can decrease

heart rate, lower blood pressure, impair respiratory function, and produce unfavorable blood lipid profiles through inhibition of lipoprotein lipase (*LPL*) in heart, muscle, and adipose tissue. *LDL* low-density lipoprotein, *HDL* high-density lipoprotein

used to treat glaucoma do cause systemic effects upon entering the circulation through the nasal mucosa by way of the lacrimal ducts (Fig. 2).

Drugs targeting  $\beta$ -adrenergic receptors can decrease systemic blood pressure (see chapter “[Hypertension](#)”) and pulse rate (see chapters “[Atherosclerotic heart disease](#)” and “[Heart failure](#)”), as well as cause bronchospasm and negatively affect blood glucose levels and lipid profile, the latter through impairing low-density lipoprotein and triglyceride metabolism by inhibiting lipoprotein lipase (*LPL*, see chapter “[Hyperlipidemia](#)”) [19]. Conflicting research on the safety of topical  $\beta$ -blockers exist: several studies have found no increase in cardiovascular events [21] or respiratory issues in elderly populations [22], but others found an increased risk of developing airway obstruction [23].

## Perspectives

The relationship between metabolism and glaucoma is murky as most of the links examine the connection between metabolism and elevated IOP, a risk factor for glaucoma, rather than glaucoma itself. Given the variety of glaucomas, the variability in disease progression, the intricate relationships between the risk factors, and the specific mechanisms proposed to contribute to the pathology, it is very likely that several metabolic changes can impact the development or progression of the disease.

An area of great interest in glaucoma research is the development of a “complete therapy,” where mechanisms of neurodegeneration are addressed in addition to lowering IOP [18]. At present, there are no dedicated neuroprotective



agents used for the treatment of glaucoma (although some of the existing IOP-lowering drugs such as brimonidine are thought to have neuroprotective effects). Researchers are currently exploring a number of avenues—some of which could potentially have effects on metabolism—such as drugs affecting hemodynamics, mitochondrial function, or  $\text{Ca}^{2+}$  dynamics. With a projected increase in glaucoma prevalence, this avenue represents one of the best hopes for reducing disease burden in the future.

## References

1. Quigley HA, Broman AT (2006) The number of people with glaucoma worldwide in 2010 and 2020. *Br J Ophthalmol* 90:262–267
2. Gordon MO, Beiser JA, Brandt JD, Heuer DK, Higginbotham EJ, Johnson CA, Keltner JL, Miller JP, Parrish RK 2nd, Wilson MR, Kass MA (2002) The ocular hypertension treatment study: baseline factors that predict the onset of primary open-angle glaucoma. *Arch Ophthalmol* 120:714–720
3. Shields MB (2008) Normal-tension glaucoma: is it different from primary open-angle glaucoma? *Curr Opin Ophthalmol* 19(2):85–88
4. Sommer A (1989) Intraocular pressure and glaucoma. *Am J Ophthalmol* 107:186–188
5. Crish SD, Calkins DJ (2011) Neurodegeneration in glaucoma: progression and calcium-dependent intracellular mechanisms. *Neuroscience* 176:1–11
6. Wilson WA (1969) Ocular findings in several metabolic diseases. *Calif Med* 111:446–449
7. Mapstone R, Clark CV (1985) Prevalence of diabetes in glaucoma. *BMJ* 291:93–95
8. Jonas JB, Grundler AE (1998) Prevalence of diabetes mellitus and arterial hypertension in primary and secondary open-angle glaucomas. *Graefes Arch Clin Exp Ophthalmol* 236:202–206
9. Tan GS, Wong TY, Fong CW, Aung T (2009) Diabetes, metabolic abnormalities, and glaucoma. *Arch Ophthalmol* 127:1354–1361
10. Imai K, Hamaguchi M, Mori K, Takeda N, Fukui M, Kato T, Kawahito Y, Kinoshita S, Kojima T (2010) Metabolic syndrome as a risk factor for high-ocular tension. *Int J Obes (London)* 34:1209–1217
11. Guiraudou M, Varlet-Marie E, Raynaud de Mauverger E, Brun JF (2013) Obesity-related increase in whole blood viscosity includes different profiles according to fat localization. *Clin Hemorheol Microcirc* 55:63–73
12. Newman-Casey PA, Talwar N, Nan B, Musch DC, Stein JD (2011) The relationship between components of metabolic syndrome and open-angle glaucoma. *Am Acad Ophthalmol* 118:1318–1326
13. Bulpitt CJ, Hodes C, Everitt MG (1975) IOP and systemic blood pressure in the elderly. *Br J Ophthalmol* 59:717–720
14. Oh SW, Lee S, Park C, Kim DJ (2005) Elevated IOP is associated with insulin resistance and metabolic syndrome. *Diabetes Metab Res Rev* 21:434–440
15. Cherecheanu AP, Garhofer G, Schmidl D, Werkmeister R, Schmetterer L (2013) Ocular perfusion pressure and ocular blood flow in glaucoma. *Curr Opin Pharmacol* 13:36–42
16. Tielsch JM, Katz J, Sommer A, Quigley HA, Javitt JC (1995) Hypertension, perfusion pressure, and primary open-angle glaucoma. A population-based assessment. *Arch Ophthalmol* 113:216–221
17. Leske MC (2009) Ocular Perfusion pressure and glaucoma: clinical trial and epidemiologic findings. *Curr Opin Ophthalmol* 20:73–78
18. McKinnon SJ, Goldberg LD, Peeples P, Walt JG, Bramley TJ (2008) Current management of glaucoma and the need for complete therapy. *Am J Manag Care* 14:S20–S27
19. Taniguchi T, Kitazawa Y (1997) The potential systemic effect of topically applied beta-blockers in glaucoma therapy. *Curr Opin Ophthalmol* 8:55–58
20. Sommer A, Tielsch J (2008) Blood pressure, perfusion pressure, and open-angle glaucoma. *Arch Ophthalmol* 126:741, author reply 741–742
21. Monane M, Bohn RL, Gurwitz JH, Glynn RJ, Chodnovskiy I, Avorn J (1994) Topical glaucoma medications and cardiovascular risk in the elderly. *Clin Pharmacol Ther* 55:76–83
22. Huerta C, García Rodríguez LA, Möller CS, Arellano FM (2001) The risk of obstructive airways disease in a glaucoma population. *Pharmacoepidemiol Drug Saf* 10:157–163
23. Kirwan JF, Nightingale JA, Bunce C, Wormald R (2002) Beta blockers for glaucoma and excess risk of airways obstruction: population based cohort study. *BMJ* 325:1396–1397

---

**Part III**  
**Teeth and Bones**

---

## Overview

Kazuhiko Kawasaki and Kenneth M. Weiss

---

### Anatomy and Physiology of Teeth and Bones

Bone and teeth comprise the mineralized hard tissues of the human body. They have evolved from a hard external skeleton in early vertebrates that led eventually to bony plates, teeth, and scales as well as to the internal skeleton that characterizes modern jawed vertebrates [1]. Bone and teeth form in organic extracellular matrix. The mineral component essentially consists of hydroxyapatite (i.e., a special calcium phosphate,  $\text{Ca}_{10}(\text{PO}_4)_6(\text{OH})_2$ ) with various potential substitutes, such as fluoride, replacing hydroxide (see chapter “Dental caries”). The organic constituents vary in different tissues [1]. Bone consists of ~65 % (w/w) minerals, 25 % organic matrix (~95 % of which are collagen fibrils), and water. The tooth consists of a bulk of dentin covered with enamel on the crown (Fig. 1a). Dentin is similar to bone in proportion of mineral (~70 % w/w) and collagen fibrils, but includes different non-collagenous proteins. Unlike bone and dentin, enamel is a highly mineralized (~97 % w/w), virtually inorganic tissue; its initial organic matrix is removed through specific maturation

processes [2]. In addition to these three principal hard tissues, the roots of the teeth are covered by cementum, a bone-like tissue (Fig. 1a).

The tooth is essential for mastication and also important for proper speech and aesthetics [2], while bone constitutes the skeleton, which supports and protects our body and enables movement. In addition, bone is critical to the homeostasis of calcium and phosphate [3–5]. In the following, growth of bone and teeth is briefly explained.

### Bone Growth

Bone can develop by two mechanisms, i.e., intramembranous ossification or endochondral ossification [3, 4], in which cartilage is not present or serves as a model, respectively. In intramembranous ossification, mesenchymal cells proliferate and condense. Some of these cells differentiate into osteoblasts, which secrete organic matrix of bone. As osteoblasts secrete the bone matrix, some become entrapped within the matrix. These cells are referred to as osteocytes. Intramembranous bones grow appositionally by recruiting newly differentiated osteoblasts. It takes place in most bones of the skull. In contrast, endochondral ossification uses a cartilage model. The cartilage model grows interstitially by proliferation and differentiation of chondrocytes, with the old cartilage model progressively getting replaced by endochondral bone. During this process, mineralized portions of cartilage are partially resorbed by chondroclasts (similar

---

K. Kawasaki • K.M. Weiss (✉)  
Department of Anthropology, Pennsylvania  
State University, 409 Carpenter Building,  
University Park, PA 16802-3404, USA  
e-mail: [kuk2@psu.edu](mailto:kuk2@psu.edu); [kenweiss@psu.edu](mailto:kenweiss@psu.edu)

**a Tooth**

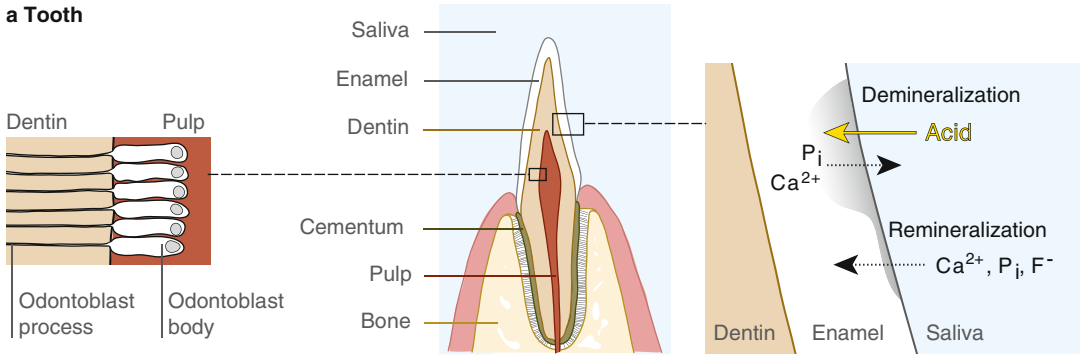

**b Bone**

Bone remodeling

(i) Bone resorption

(ii) Bone formation

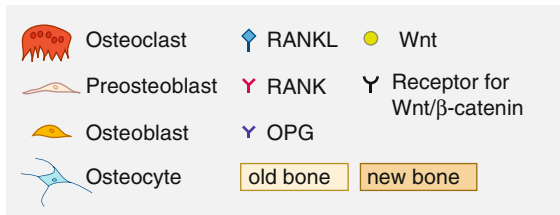
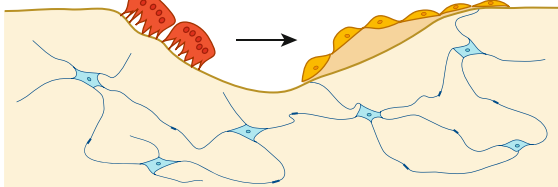

(i) Bone resorption

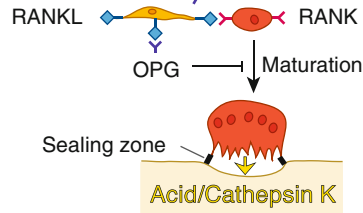

(ii) Bone formation

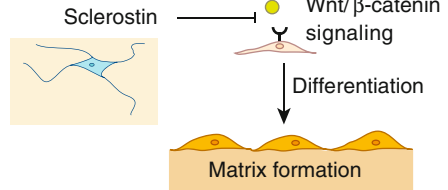

**Fig. 1** Tooth-specific (a) and bone-specific (b) metabolic pathways. (a) A sagittal section of a tooth is illustrated in the middle showing the different zones and structures in a human tooth. The pulp-dentin border is enlarged on the left. In the right enlargement, flows of calcium ( $Ca^{2+}$ ), phosphate ( $P_i$ ), and fluoride ( $F^-$ ) during demineralization and remineralization are shown. The yellow

arrow represents acid, e.g., produced by cariogenic bacteria. (b) Bone remodeling progresses through (i) bone resorption and (ii) bone formation, driven by osteoclasts and osteoblasts, respectively (left). Principal regulatory mechanisms in these processes are illustrated on the right. RANK receptor activator of nuclear factor- $\kappa$ B, RANKL RANK ligand, OPG osteoprotegerin

to osteoclasts, see below), and osteoblasts that have invaded the cartilaginous model secrete bone matrix onto the remaining cartilage. Endochondral ossification takes place, e.g., in the long bones of the skeleton.

Throughout our lives, bone undergoes remodeling, the coupling of bone resorption by osteoclasts and bone formation by osteoblasts (Fig. 1b). By remodeling, bone can meet changing mechanical demands, prevent the accumulation of micro-damage, and regulate calcium homeostasis.

**Tooth Growth**

The organic matrix of dentin is secreted by odontoblasts that align in the pulp cavity and extend the cell process to the dentin-enamel junction (Fig. 1a) [2]. The odontoblast process is thought to serve as the secretory conduit for particular matrix proteins. After primary dentin is completed finally in the root, odontoblasts continue to secrete dentin matrix, but at reduced rates. This secondary dentin formation continues throughout

life, and the pulp space reduces progressively with age.

Enamel matrix is secreted by ameloblasts that overlay the forming enamel surface. Before tooth eruption, ameloblasts fuse with the oral epithelium and the cells covering the top of the crown subsequently degenerate, leaving mature enamel acellular. The enamel is highly mineralized and wear resistant, but this tissue is brittle and fractures by the forces of mastication. However, the enamel is supported by underlying dentin, which is more resilient and compensates for the brittleness of enamel.

Humans have two complete sets of dentition. The deciduous teeth are replaced by the permanent successors with additional permanent molars erupting behind the deciduous tooth row. During tooth replacement, dentin and cementum of deciduous teeth are resorbed, and the jaw bone is remodeled.

---

## Calcium and Phosphate Metabolism and Physiological Reactions in Bone and Tooth

### Bone Remodeling

Bone remodeling progresses through bone resorption and bone formation (Fig. 1b) [3]. For resorption, preosteoclasts, derived from the hematopoietic lineage, first mature into multinucleated osteoclasts, which adhere to the bone surface and form a closed compartment.

Into this sealing zone, osteoclasts secrete acid (protons) and proteolytic enzymes, including cathepsin K. The acid dissolves hydroxyapatite, whereas cathepsin K digests collagens and other organic bone constituents. Following bone resorption, osteoclasts probably produce signals for new bone formation, although the details remain unclear.

The receptor activator of nuclear factor- $\kappa$ B ligand (RANKL), a membrane-bound cytokine that is presented by various cells in the osteoblast lineage, plays a critical role for differentiation of osteoclasts [3] (Fig. 1b). RANKL binds its receptor, RANK, on osteoclast precursor cells, thereby

inducing their maturation and subsequent bone resorption, as well as promoting the survival of osteoclasts. The RANKL-RANK interaction can be interrupted by antagonistic binding of osteoprotegerin (OPG) to RANK. OPG is a soluble receptor, secreted by osteoblast-lineage cells. Thus, the local RANKL/OPG ratio determines the activity of RANK signaling that induces bone remodeling.

For bone formation, osteocytes play an essential role [4]. Osteocytes represent osteoblast-derived cells that are embedded in bone (Fig. 1b). Osteoblasts that do not differentiate to osteocytes either line the surface of quiescent bone or undergo apoptosis. In bone, osteocytes lie in lacunae and extend cell processes through canaliculi. These processes form a network with other osteocytes and osteoblasts present on the bone surface (Fig. 1b). It is thought that osteocytes sense mechanical strain as shear stress in interstitial fluid filling the lacuna-canalicular system.

In response to mechanical loading, osteocytes suppress expression of the sclerostin gene [3]. Sclerostin antagonizes Wnt/ $\beta$ -catenin signaling that induces differentiation of preosteoblasts to osteoblasts and the production of bone matrix (Fig. 1b). Furthermore, mechanical loading may cause microdamage and osteocyte apoptosis near the damage site. However, surviving osteocytes activate the production of RANKL and suppress OPG production, thus inducing bone resorption (Fig. 1b). Subsequent bone formation would eventually repair the microdamage.

The bone remodeling cycle ends when resorbed bone is completely replaced by new bone. Imbalance of bone resorption and bone formation may lead to a loss of bone mass and strength, that is, osteoporosis (see chapter “Osteoporosis”). In addition to replacement, bone remodeling is important for homeostasis of calcium and phosphate, and bone serves as the reservoir of these ions. Bone is thus highly vascularized, which is essential for the transport of calcium and phosphate, as well as oxygen and nutrients (common to teeth). A rich vasculature also facilitates the circulation of various hormones that regulate bone remodeling (see below). Another important function of bones is to provide

the space for the bone marrow, in which various blood cells develop from hematopoietic stem cells. The bone marrow is crucial for the hematopoietic system (see chapter “[Overview](#)” under part “[Blood](#)”) and immune system (see chapter “[Overview](#)” under part “[Immune system](#)”).

### Calcium Metabolism in Teeth

Unlike bone that undergoes dynamic remodeling, teeth are less metabolically active, resorbed only during replacement in normal physiological conditions. Yet, the superficial layer of enamel repeats demineralization and remineralization (Fig. 1a) [2], especially when challenged (see chapter “[Dental caries](#)”). Remineralization occurs by deposition of calcium, phosphate, and fluoride, supplied by saliva. Fluoride-substituted hydroxyapatite is more acid resistant, and fluoride selectively remains in enamel. A similar process is known as post-eruptive maturation. Shortly after eruption of the developing tooth, the enamel is more permeable and susceptible to acid dissolution. Incorporation of calcium, phosphate, and fluoride into such enamel from saliva increases surface hardness and resistance to demineralization.

If demineralization dominates remineralization in enamel, dental caries progresses (see chapter “[Dental caries](#)”). When caries process reaches dentin, odontoblasts respond by inductive mineralization in two principal ways, tubular sclerosis and tertiary dentin formation. Tubular sclerosis represents mineralization of dentinal tubules that enclose odontoblast processes. Tertiary dentin forms in the pulp by preexisting odontoblasts or newly differentiated odontoblast-like cells.

### Bone and Tooth: Roles in Calcium-Phosphate Homeostasis

In adult humans, 5–10 % of bone is remodeled each year. Such high rates of bone turnover are essential for the homeostasis of calcium and phosphate in the extracellular fluid (mostly blood plasma and interstitial fluid) to ensure physiological activities [4, 5]. Approximately 99 % of calcium and 80 % of phosphate in our body are located in

bone and teeth as hydroxyapatite crystals, primarily providing the rigidity of these structures. Thus, metabolically more active bone is considered as the reservoir of calcium and phosphate. The homeostasis of calcium and phosphate is regulated in a dynamic equilibrium accomplished by intestinal absorption, renal excretion, and bone remodeling through hormonal controls, largely by parathyroid hormone (PTH) and calcitriol (Fig. 2) [3, 5]. Calcitriol is the active form of vitamin D<sub>3</sub>; vitamin D<sub>3</sub> (cholecalciferol) is synthesized in the skin or ingested with the food and sequentially hydroxylated initially to calcidiol in the liver and then to calcitriol in the kidney.

Changes in the calcium concentration within the extracellular fluid are detected by the calcium sensing receptor (CaR) in the parathyroid glands [3]. There, a rise in calcium concentration leads to suppression of the synthesis and secretion of PTH (Fig. 2). Conversely, a decrease in calcium concentration enhances PTH secretion.

PTH binds its receptor (parathyroid hormone 1 receptor; PTH1R) in the kidney, which leads to calcium reabsorption, phosphate excretion, and hydroxylation of calcidiol to calcitriol (Fig. 2) [3, 5]. In the small intestine, calcitriol increases absorption of calcium and phosphate. Furthermore, PTH induces bone resorption (see below). These mechanisms cooperatively increase the calcium concentration in the extracellular fluid. The increased concentrations of calcium and phosphate could cause their pathological precipitation. However, such precipitation is prevented by phosphate excretion mediated by PTH. Calcitriol suppresses PTH gene expression in the parathyroid glands, acting as a negative feedback regulator. The interplay of PTH and calcitriol is essential for calcium and phosphate homeostasis (Fig. 2).

PTH also affects bone, causing an increase in bone resorption (triggered, e.g., by calcium-deficient diet) [3, 5]. PTH binds PTH1R on osteoblast-lineage cells, thereby activating RANKL expression and suppressing OPG expression. This induces bone resorption (Fig. 1b). Paradoxically, intermittent administration of PTH at low doses increases bone formation probably through suppression of the sclerostin gene and enhancing Wnt/ $\beta$ -catenin signaling (Fig. 1b).

**Fig. 2** Metabolic pathways of calcium ( $Ca^{2+}$ ) and phosphate ( $P_i$ ) involving bone, kidney, small intestine, and parathyroid glands. An increase and a decrease of calcium concentration in the extracellular fluid (ECF) are detected by the calcium sensing receptor ( $CaR$ ). Physiological doses of calcitriol do not stimulate bone resorption, but pharmacological or toxic doses of calcitriol induce bone resorption

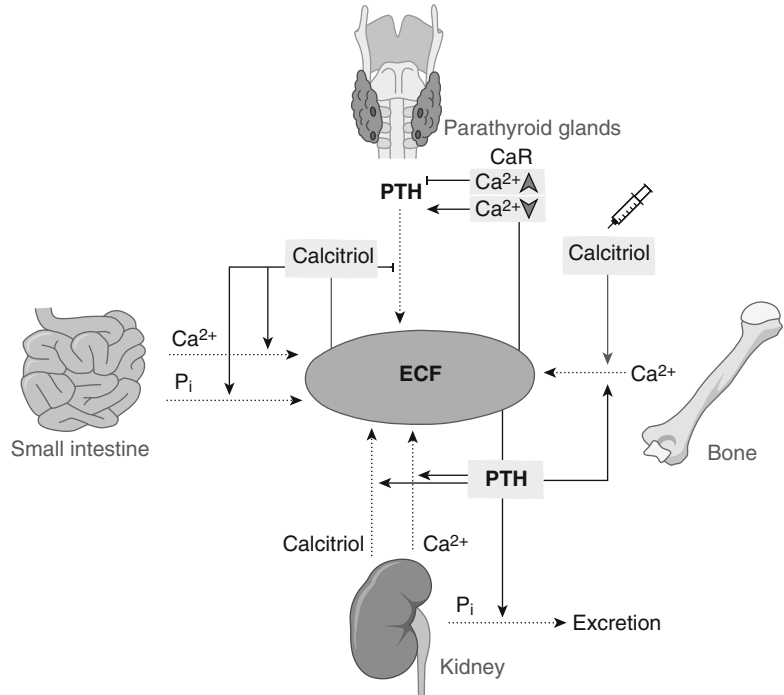

It has been postulated that calcitriol also induces bone resorption by activating RANKL and suppressing OPG production directly in osteoblast-lineage cells [3]. However, this action has been only detected by administration of calcitriol at pharmacological doses. At physiological doses, calcitriol reduces bone resorption partly by suppressing PTH production (Fig. 2).

### Final Remarks

A toothlike structure originated on the surface of dermal bone in Paleozoic jawless fish. So, bone and teeth both evolved as skeletal elements, which provide mechanical strength. As vertebrates invaded terrestrial environments, where calcium and phosphate may not be as freely available as they were in aquatic environments, bone became even more important not only to convey stability in an environment of lower density (air versus water) but also as the storage of calcium and phosphate, which ensures the organism's metabolism. The tooth is less metabolically active, serving mainly for

mastication. Yet, even though the tooth surface is acellular, it repeats demineralization and remineralization. Similarly, bone is constantly remodeled by osteoblasts and osteoclasts to adapt to changing needs (of the skeleton), repair damage, and regulate mineral metabolism. An imbalance of calcium and phosphate metabolism in teeth and bone may result in potentially life-threatening conditions including caries (see chapter “Dental caries”) and osteoporosis (see chapter “Osteoporosis”), respectively.

### References

1. Kawasaki K, Buchanan AV, Weiss KM (2009) Biomineralization in humans: making the hard choices in life. *Annu Rev Genet* 43:119–142
2. Nanci A (2013) Ten Cate's oral histology, 8th edn. Elsevier, St. Louis
3. Bilezikian JP, Raisz LG, Martin TJ (eds) (2008) Principles of bone biology, 3rd edn. Elsevier, Amsterdam
4. Marcus R, Feldman D, Nelson DA, Rosen CJ (eds) (2008) Osteoporosis, 3rd edn. Elsevier, Boston
5. Marcus JS, Robins SP, Bilezikian JP (eds) (2006) Dynamics of bone and cartilage metabolism, 2nd edn. Academic, San Diego

---

# Dental Caries

Colin Robinson

---

## Introduction to Dental Caries

Dental caries uniquely is prevalent worldwide and the annual oral health costs in Europe are estimated at €79 billion [1]. Essentially, the tooth's outer covering, dental enamel and subsequently the sub-adjacent dentine are attacked and eventually destroyed by bacterially produced acid. If untreated this often results in infection of the alveolar bone of the jaw leading in turn to systemic infection including endocarditis. If the tooth is lost, supporting bone of the tooth socket is also resorbed exposing roots of previously healthy adjacent teeth to further attack by oral bacteria and toothbrush wear. Therapeutic treatment is only possible before the enamel surface is breached, after which restoration materials are inserted following drilling out of porous carious tissue. Since enamel is acellular, enamel caries occurs without the participation of host cells and is essentially a chemical process.

Dental enamel comprises ~97 % inorganic crystals of a calcium hydroxyapatite mineral, similar to crystals in dentine, cementum and bone (see chapter “**Overview**” under part “Teeth and bones”). Enamel crystals are, however, much larger and better formed being 30–50 nm in thickness and width and up to 500 nm in length [2]. Several thousand crystals are packed parallel to each other into 4–5 µm diameter bundles, the

enamel prisms, extending from dentine towards the enamel surface [3].

Apatite crystals exhibit many ion substitutions (Fig. 1) [4–6]. Important from a therapeutic viewpoint, fluoride ion substitution for hydroxyl ions dramatically reduces acid solubility and facilitates precipitation while carbonate and magnesium have an opposite effect [7]. Fluoride ion stabilises the crystal by reducing lattice energy and improving crystallinity, while carbonate and magnesium distort the regular arrangement of ions leading to instability.

---

## Pathophysiology of Dental Caries and Metabolic Alterations

Several hundred species of bacteria are resident in the oral cavity [8]. Of these 30–50 are regarded as cariogenic. The *mutans streptococci* have received most attention in this respect. Cariogenic bacteria form a biofilm, dental plaque, in the deeper fissures of molar teeth, around contact areas between adjacent teeth (interproximal sites) and at the gum margin. Oral bacteria colonise a protein layer on enamel surfaces, many proteins of which are unique to saliva [9]. This produces a biofilm with channels often extending from saliva to the enamel surface and mushroom-shaped biomass, structures typical of nutrient rich biofilms [10]. Caries is mediated by acid products of plaque biofilm metabolism [11].

Plaque acid initially dissolves the calcium hydroxyapatite crystals at prism and crystal surfaces, which are rich in carbonate [2]. While

---

C. Robinson  
Dental Institute, University of Leeds,  
Clarendon Way, LS2 9LU Leeds, UK  
e-mail: [c.robinson@leeds.ac.uk](mailto:c.robinson@leeds.ac.uk)



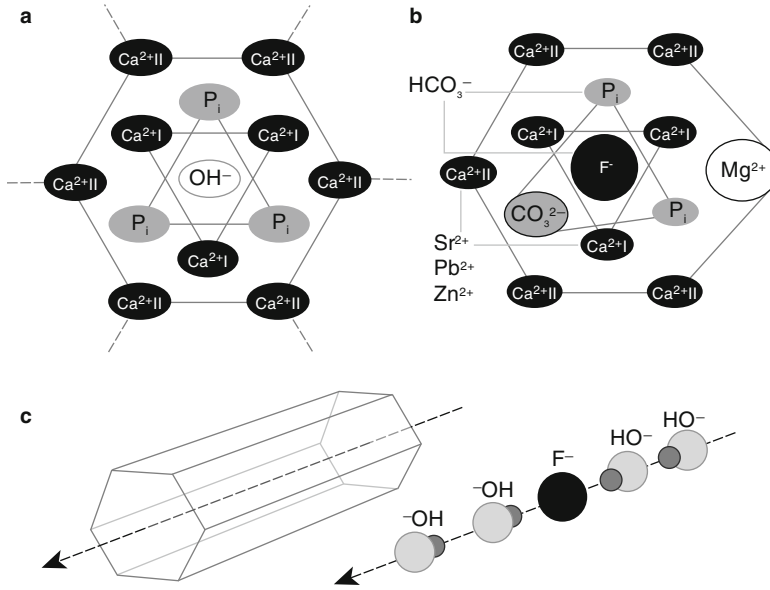

**Fig. 1** Chemical composition of hydroxyapatite. (a) View of a regular, non-distorted hexagonal unit cell of hydroxyapatite in the tooth down the long c-axis. One layer of a unit crystal is shown. The positions of inner ( $Ca^{2+} I$ ) and outer ( $Ca^{2+} II$ ) calcium ions, as well as phosphate ions ( $P_i$ ), are shown. Please note that outer  $Ca^{2+}$  ions also “belong” to two neighbouring apatite crystals (shown with dotted lines). A hydroxyl ion ( $OH^-$ ) is shown in the centre. For a complete hydroxyapatite unit cell, a second layer must be added, rotated by  $60^\circ$ , so that  $Ca^{2+}$  will be placed atop  $P_i$ , resulting in the chemical formula of  $Ca^{2+}_{10}(PO_4^{3-})_6(OH^-)_2$ . (b) View of a substituted, distorted hydroxyapatite hexagonal unit cell down the long c-axis showing possible

substitutes. A fluoride ( $F^-$ ) ion is shown in the centre position. Close fit and high electronegativity of fluoride ions confer stability on the crystal with regard to acid. Distortions due to carbonate ( $CO_3^{2-}$ ) and magnesium ( $Mg^{2+}$ ) ions are indicated resulting in less well-ordered crystals and greater acid solubility. Locations of other substituent ions are shown, e.g.  $Sr^{2+}$ ,  $Pb^{2+}$ ,  $Zn^{2+}$ .  $HPO_4^{2-}$  and  $HCO_3^-$  can also be present. Charge balance is maintained by loss of calcium or hydroxyl ions. (c) View of hydroxyapatite crystal showing the long c-axis with a fluoride substituting for one hydroxyl ion. The orientation of hydroxyl ions is altered such that the hydroxyl protons are oriented towards the fluoride ion. This increases stability of the crystals towards acid [13]

the lesion front advances relatively quickly, the lesion surface appears to remain intact due to reprecipitation of dissolved crystals facilitated by high surface levels of fluoride [12–14].

Histological studies of caries lesions reveal pores, which progressively increase in size until mechanical breakdown occurs. These are visible as a series of zones (Fig. 2a) [12]. Initial dissolution

**Fig. 2** Pathophysiology of dental caries. (a) Overview image of an affected tooth indicating the section shown in (b). (b) Section through an interproximal (white spot) caries lesion of enamel showing histological zones of the lesion. (c) Schematic drawing of pore structure and changes in crystal appearance, due to dissolution, at each stage with the earliest stage to the right: translucent zone (1% mineral loss) through the dark zone (5% mineral loss) to the body of the lesion (20–50% mineral loss). Pore size increases at each stage with additional small pores indicating crystal regrowth/remineralsation in the dark zone indicated by darker areas, later dissolved in the lesion body. (d) Graphical illustration of chemical changes to enamel crystals (hexagons) at each stage of lesion development (from right to left). Intact prisms and crystals are present in healthy teeth (sound enamel). Large, selective loss of carbonate and magnesium ions and increase in fluoride occurs during the first stage (translucent zone), where dissolution of prism boundaries and crystal sur-

faces starts. Subsequent reprecipitation of dissolved mineral occurs in the dark zone (dark areas in c). Dissolution continues even of this stable reprecipitated mineral (lesion body) as pH falls towards the plaque biofilm on the enamel surface. The surface zone contains a range of poorly defined/bulky calcium phosphate materials. (e) Ionic alterations in different zones of a caries lesion showing relative changes of important ions and conditions (arbitrary units). Whereas the fluoride content is relatively low in sound enamel, it continuously rises along the lesion progression, with a steep rise during the body and highest concentration on the enamel surface. Calcium and phosphate are also high at the surface and in sound enamel. Their minimal concentration can be found in the body of the lesion. Carbonate and magnesium ions are maximal in sound enamel and drop continuously towards the surface. Similarly, pH is highest in sound enamel and continuously drops towards the surface [13]

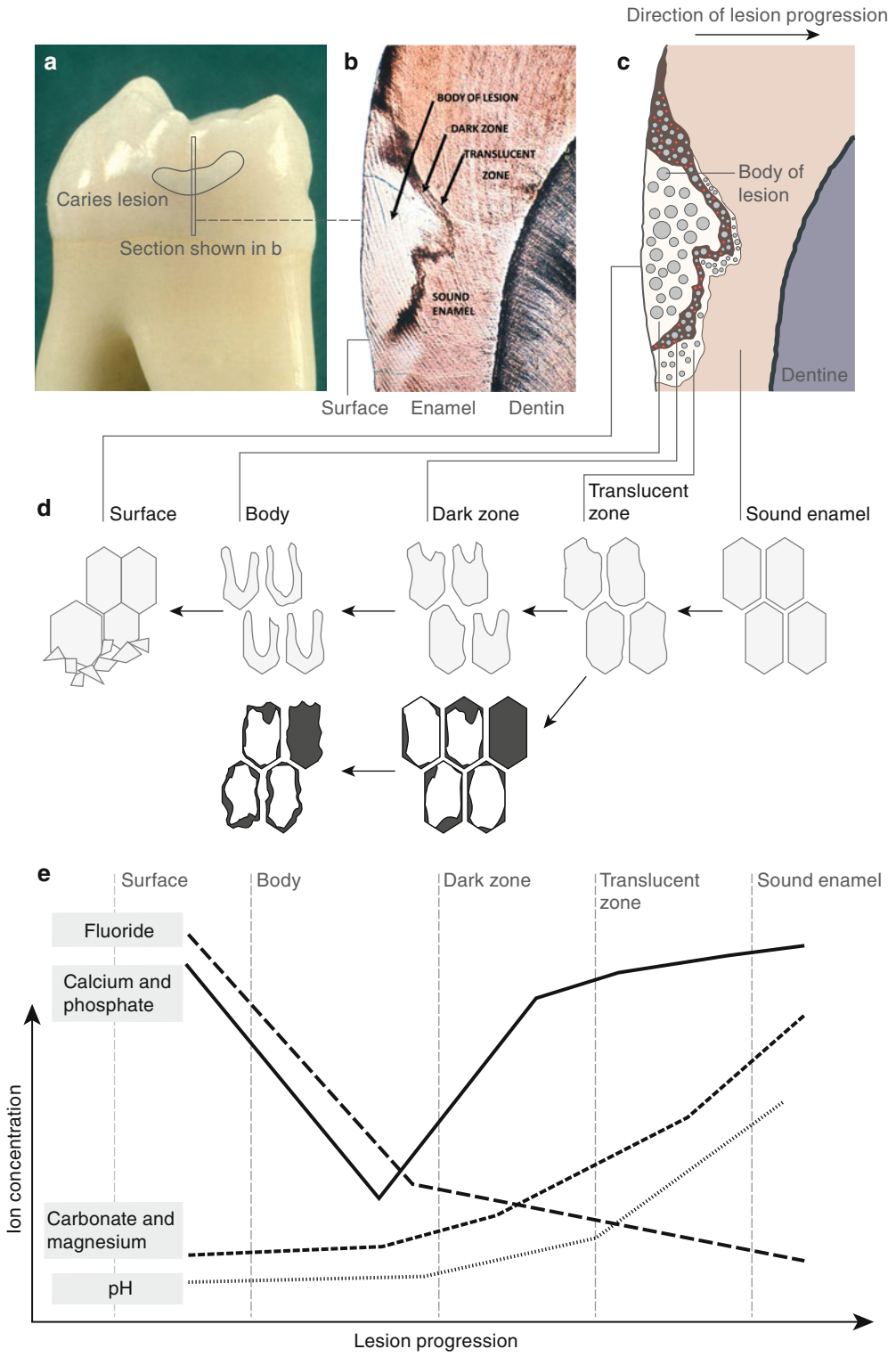

of crystal surfaces produces the translucent zone, with ~1 % mineral loss (Fig. 2b). This is succeeded by the dark zone [15] with larger pores and ~5 % mineral loss. The dark appearance is due to the additional generation of much smaller pores, which do not admit media such as quinoline, which has the same refractive index as apatite crystals. Importantly this indicates some closing up of existing pores by regrowth of existing crystals and new crystal precipitation, i.e. remineralisation. Some accumulation of organic material has also been reported. This remineralisation, via calcium and phosphate from saliva, is facilitated by the massive loss of carbonate and magnesium, which are crystal growth inhibitors because of their destabilising effect on apatite crystals and an increase in the crystal growth promoter fluoride. The subsequently formed body of the lesion with even larger pores (20–30 % mineral loss) represents continued dissolution of even the reprecipitated material as more acid penetrates from the plaque [13].

Demineralsation and remineralisation can thus occur at the same time in the same lesion depending on concentration gradients of fluoride, carbonate, magnesium and pH [13].

---

## Treatment and Implications for Patients

Earliest carious changes involve chemical alterations, which are not normally visible on the tooth surface. As the disease progresses, caries is most often seen as a white spot on the tooth surface resulting from porosity generating light scatter. This may progress to greater mineral loss which can be detected radiographically.

Therapeutic treatment falls into two areas: first and primarily reconstituting tooth material (by supplementing mineral ions) and second acid reduction (by antibacterial treatment to reduce the pH gradient). Acid production can be inhibited by broad-spectrum antibacterial agents in toothpastes and mouthwashes. These include chlorhexidine [16], a bisbiguanide, which disrupts cell membranes and triclosan [17], a polychlorophenoxyphenol, which inhibits fatty acid synthesis. This approach is effective, but repeated application to continuously renewing plaque

raises issues of bacterial resistance and the possibility of long-term effects on oral soft tissues. Inclusion of buffers in toothpastes and mouthwashes to correct pH has a limited effect due to their relatively short half-life in the mouth.

Mineral ions can be supplemented to the lesion site to promote remineralisation [18]. Fluoride in particular is remarkably effective, reducing the disease by 50–70 %. Originally thought to increase enamel resistance via incorporation into crystals during development, later emphasis shifted towards a topical remineralising effect on the lesion itself [19]. Fluoride can be supplied to the tooth surface via the diet, drops or tablets entering the saliva directly or via the bloodstream. Topical application via toothpastes and mouthwashes is also effective [20, 21]. Why continuous supply of fluoride is necessary is not perfectly understood but is likely related to maintenance of a concentration gradient into the lesion through the plaque biofilm [22]. Fluoride inhibition of plaque acid production may also contribute. More generally, removal of biofilm by flossing and toothbrushing twice daily for about 2 min is also effective by removing acid generating bacteria and lowering the overall bacterial load.

---

## Influence of Treatment on Metabolism

The antibacterials described above are not retained in the mouth except in small amounts and usually for limited periods. Significant effects on general metabolism have so far not been reported. Treatment with fluoride results in increased acid resistance of the enamel by substitution of fluoride for hydroxyl ions in the enamel apatite crystals. Fluoride also stimulates regrowth of acid damaged crystals and redeposition of new crystals enriched in fluoride and depleted in carbonate and magnesium [13].

Continuous availability of topical fluoride at the levels currently used has not resulted in discernible side effects on oral or indeed any other tissue. However, ingested fluoride in excessive amounts during tooth development can result in tissue changes [23]. Up to ~1 ppm in the water supply produces few observable effects. Above this level,

crystal development is impaired and porosity in enamel results, which increases in severity with fluoride concentration. In extreme cases bone can be affected. Several mechanisms may operate here, including increased apatite-protein binding to crystal growth sites limiting crystal growth [23] and more recently alterations in cytoskeletal behaviour in the enamel forming ameloblasts [24]. This may inhibit removal of proteins and/or access of calcium phosphate to the growing crystals. Several guidelines have been published with regard to optimal dietary fluoride levels [25].

## Perspectives

The most effective current anticaries therapy is fluoride. Administration via the drinking water is extremely effective and is relatively inexpensive. However, interpreted as mass medication and with the risk of fluorotic changes, this route is still somewhat controversial. Topical oral application remains the most effective and acceptable treatment but depends on individual compliance. More recently, attempts have been made to encourage remineralisation by supplying additional calcium to tooth surfaces using a calcium-protein complex and via administration of peptides, which nucleate the deposition of new hydroxyapatite crystals. New approaches to diagnosing very early chemical changes in the enamel surface, driving fluoride deep into the lesion more effectively together with disruption of plaque and specific targeting of bacterial acid production seem the most promising way forward.

## References

1. Oral health means more than just good teeth. [www.oral-healthplatform.eu](http://www.oral-healthplatform.eu). As available on 1 Aug 2013
2. Johansen E (1965) Comparison of the ultrastructure and chemical composition of sound and carious enamel from human permanent tooth. In: Stack MV, Fearnhead RW (eds) *Tooth enamel, its composition, properties, and fundamental structure*. John Wright & Sons Ltd., Bristol, pp 177–181
3. Boyde A (1989) Enamel. In: Oksche A, Vollrath L (eds) *Handbook of microscopic anatomy, vol V/6, Teeth*. Springer, Berlin, p 309
4. Kay MI, Young RA, Posner AS (1964) Crystal structure of hydroxyapatite. *Nature* 204:1050–1052
5. Elliott JC, Holcomb DW, Young RA (1985) Infrared determination of the degree of substitution of hydroxyl by carbonate ions in human dental enamel. *Calcif Tissue Int* 37:372–375
6. Terpstra RA, Driessens FCM (1986) Magnesium in tooth enamel and synthetic apatites. *Calcif Tissue Int* 39:348–354
7. Moreno EC, Kresak M, Zahradnik RT (1974) Fluoridated hydroxyapatite, solubility and caries formation. *Nature* 247:64–65
8. Aas JA, Paster BJ, Stokes LN, Olsen I, Dewhurst FE (2005) Defining the normal bacterial flora of the oral cavity. *J Clin Microbiol* 43:5721
9. Van Nieuw Amerongen A, Bolscher JG, Veerman EC (2004) Salivary proteins: protective and diagnostic value in cariology? *Caries Res* 38:247–253
10. Wood SR, Kirkham J, Marsh PD, Shore RC, Nattress B, Robinson C (2000) Architecture of intact natural human plaque biofilms studied by confocal laser scanning microscopy. *J Dent Res* 79:21–27
11. Kleinberg I (2002) A mixed – bacterial ecological approach to understanding the role of the oral bacteria in caries causation: an alternative to the Streptococcus mutans and specific plaque hypothesis. *Crit Rev Oral Biol Med* 13:108–125
12. Darling AI (1961) The selective attack of caries on the dental enamel. *Ann R Coll Surg Engl* 29:354–369
13. Robinson C, Kirkham J, Shore RC, Brookes SJ, Wood SR, Strafford SM (2000) The chemistry of enamel caries. *Crit Rev Oral Biol Med* 11:481–495
14. Weatherell JA, Deutsch D, Robinson C, Hallsworth AS (1977) Assimilation of fluoride by enamel through the life of the tooth. *Caries Res* 11(Suppl 1):85–115
15. Silverstone LM (1967) Observations on the dark zone in early enamel caries and in artificial caries-like lesions. *Caries Res* 1:261–274
16. Hope CK, Wilson M (2004) Analysis of the effects of chlorhexidine on oral biofilm vitality and structure based on viability profiling and an indicator of membrane integrity. *Antimicrob Agents Chemother* 48:1461–1468
17. van Loveren C, Buijs JF, Ten Cate JM (2000) The effect of triclosan toothpaste on enamel demineralisation in a bacterial demineralisation model. *J Antimicrob Chemother* 45:153–158
18. Pearce EI, Schamschula RG, Cooper MH (1983) Increases in fluoride, calcium and phosphate in dental plaque resulting from the use of a mineralising mouthwash containing urea and monofluorophosphate. *J Dent Res* 62:818–820
19. Cochrane NJ, Cai F, Huq NL, Burrow MF, Reynolds EC (2010) New approaches to enhanced remineralisation of tooth enamel I. *J Dent Res* 89:1187–1197
20. Featherstone JD (1999) Prevention and reversal of dental caries: role of low level fluoride. *Community Dent Oral Epidemiol* 27:31–40
21. Marinho VC, Higgins JP, Sheiham A, Logan S (2003) Fluoride toothpastes for preventing dental caries in

- children and adolescents. *Cochrane Database Syst Rev* (1):CD002278
22. Watson PS, Pontefract HA, Devine DA, Shore RC, Nattress BR, Kirkham J, Robinson C (2005) Penetration of fluoride into natural plaque biofilms. *J Dent Res* 84:451–455
  23. Robinson C, Connell S, Kirkham J, Brookes SJ, Shore RC, Smith AM (2004) The effect of fluoride on the developing tooth. *Caries Res* 38:268–276
  24. Li Y, Decker S, Yuan ZA, DenBesten PK, Aragon MA, Jordan-Sciutto K, Abrams WR, Huh J, McDonald C, Chen E, MacDougall M, Gibson CW (2005) Effects of fluoride on the actin cytoskeleton of murine ameloblasts. *Arch Oral Biol* 50: 681–688
  25. Fawell J, Bailey K, Chikton E, Dahi E, Fewtrell L, Magara Y (2006) Fluoride in drinking water. WHO, IWA Publishing, London, Seattle

---

# Osteoporosis

Emmanuel Biver and René Rizzoli

---

## Introduction to Osteoporosis

Osteoporosis is a skeletal disorder characterized by low bone mass and microarchitectural deterioration of bone tissue, leading to an increase in bone fragility and susceptibility to fracture. An operational definition of osteoporosis has also been defined, based on a value for bone mineral density (BMD) 2.5 standard deviations or more below the young adult mean [1]. The most widely validated technique for the quantitative assessment of BMD is dual-energy X-ray absorptiometry. Bone loss is due to an imbalance between bone resorption by osteoclasts and bone formation by osteoblasts, which are part of the bone remodeling process. This results in a decrease in BMD and alterations of bone geometry and micro-architecture at the cortical and trabecular sites, leading to bone fragility and fractures. Osteoporosis has the potential to alter quality of life and to increase mortality. From the age of 50 years, 50 % of women and 20 % of men will be concerned by fracture during their remaining lifetime. This important public health issue will tend to increase due to the aging of the world

population. Beyond aging, many pathological conditions (e.g., endocrine diseases, chronic inflammatory diseases) or treatments (e.g., corticosteroids) interfere with bone metabolism and induce osteoporosis.

---

## Pathogenesis of Bone Loss

Many factors regulating bone remodeling contribute to osteoporosis (Fig. 1). Both increased bone resorption and decreased formation can contribute to its progression. Significant bone loss occurs in both women and men because of sex steroid deficiency and environmental risk factors, including nutritional intake and lifestyle habits.

## Genetic and Lifestyle Habit Risk Factors and Comorbidities

Genetic factors account for 50–80 % of the variation among individuals in bone mass and structure. Peak bone density is achieved at the beginning of the third decade of life. Lower peak bone mass contributes to the risk of osteoporosis and fractures in later life [2]. Lifestyle habits involve excess alcohol intake or tobacco use (because of toxic effects on bone cells but also indirect effects due to endocrine changes and muscle weakness) or physical inactivity. Sporadic causes of bone loss can also be identified in about 20 % of women and 50 % of men and include glucocorticoid therapy (which inhibits bone

---

E. Biver • R. Rizzoli (✉)  
Division of Bone Diseases,  
Department of Internal Medicine Specialties,  
Faculty of Medicine, Geneva University  
Hospitals, 4 Rue Gabrielle Perret-Gentil,  
Geneva 14 1211, Switzerland  
e-mail: [emmanuel.biver@hcuge.ch](mailto:emmanuel.biver@hcuge.ch);  
[rene.rizzoli@unige.ch](mailto:rene.rizzoli@unige.ch)

**Fig. 1** Metabolic changes in age-related osteoporosis. Multiple metabolic processes in various organs are involved in the imbalance between bone resorption and formation leading to osteoporosis and contributing to the incidence of fractures. *GH* growth hormone, *IGF-1* insulin-like growth factor-1, *RANKL* receptor activator of nuclear factor- $\kappa$ B ligand, *OPG* osteoprotegerin

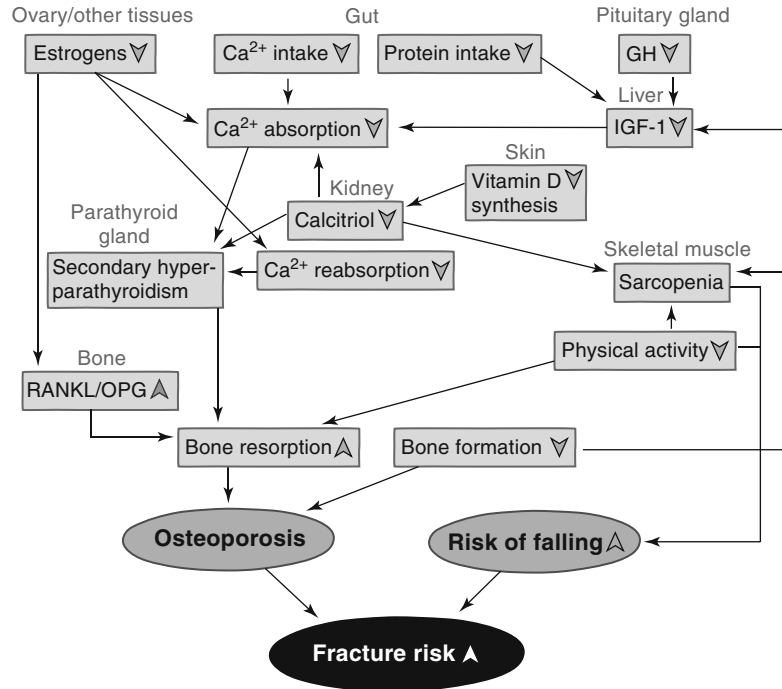

formation and suppresses calcium ( $\text{Ca}^{2+}$ ) absorption), malabsorption, idiopathic hypercalciuria (excess of urine calcium excretion without an apparent underlying etiology, due to genetic causes), or endocrine diseases, such as primary hyperparathyroidism or hyperthyroidism (all related to an imbalance of hormones affecting bone metabolism).

## Endocrine Factors

$\text{Ca}^{2+}$  and phosphate ( $\text{PO}_4^{3-}$ ,  $\text{P}_i$ ) are essential components for bone mineral formation and their availability is mainly regulated by parathyroid hormone (PTH, increasing bone resorption) and vitamin D (increasing  $\text{Ca}^{2+}$  and  $\text{P}_i$  absorption, see chapter “Overview” under part “Teeth and bones”).

One major cause of osteoporosis is the decline in estrogens after menopause but also in men, resulting in a negative balance in bone remodeling. Estrogens control bone remodeling by estrogen receptors on osteoblasts and osteoclasts. Estrogen deficiency promotes osteoclastogenesis by upregulating the receptor activator of

nuclear factor- $\kappa$ B ligand (RANKL, see chapter “Overview” under part “Teeth and bones”) in bone marrow cells, whereas estrogens stimulate the production of its soluble decoy receptor osteoprotegerin in osteoblasts. Estrogen deficiency also stimulates bone resorption by indirect effects, in particular via cells of the immune system and proinflammatory cytokines (see below). Moreover, estrogens modulate  $\text{Ca}^{2+}$  absorption and excretion.

These effects are often exacerbated by vitamin D insufficiency (calcidiol  $<50$  nmol/l), which induces secondary hyperparathyroidism (meaning increased PTH). Impaired vitamin D synthesis in skin and reduced renal hydroxylation in old age lead to low calcitriol levels.

Renal synthesis of calcitriol is regulated not only by PTH but also by insulin-like growth factor-1 (IGF-1). IGF-1 is produced in the liver in response to growth hormone (somatotropin) from the pituitary (see chapter “Overview” under part “Brain”) and dietary animal protein intake, as a diet rich in amino acids is a common inducer of growth. IGF-1 is an important regulator of muscle and bone growth, acting as



an autocrine/paracrine growth factor in multiple tissues through IGF-1 receptor, a classical tyrosine kinase receptor. IGF-1 directly regulates renal tubular reabsorption of  $P_i$  and stimulates its transport into osteoblastic cells, resulting in activation of bone mineralization. Furthermore, age-related decrease in IGF-1 levels contributes to sarcopenia by decreasing muscle size and strength, protein synthesis, and increasing muscle cell apoptosis. Sarcopenia reduces muscle loading on the skeleton and is associated with osteoporosis [3]. Consequently, a positive relationship has been found between spontaneous protein intake in both men and women and bone mass at various skeletal sites [4].

More recently, it has been shown that circulating serotonin from the gut is inversely associated with BMD. It inhibits bone mass accrual by decreasing osteoblast proliferation and bone formation [5]. Finally, leptin secreted by adipocytes stimulates bone remodeling directly through increased osteoblast proliferation and differentiation, but indirectly decreases axial skeleton bone formation through a hypothalamic relay via the sympathetic nervous system, independently of its regulation of energy metabolism.

## Nutritional Factors

Dietary factors influence bone health, particularly calcium, and protein intakes.  $Ca^{2+}$  metabolism is altered in the elderly due to impaired vitamin D levels, reduced intestinal  $Ca^{2+}$  absorption, and a lower dietary  $Ca^{2+}$  intake<sup>5</sup>. In addition, relative hypocalcemia causes secondary hyperparathyroidism, which stimulates bone resorption to maintain homeostasis in extracellular  $Ca^{2+}$  concentration (see chapter “[Overview](#)” under part “Teeth and bones”).

## Immune Factors

Many cytokines, such as interleukin 1, interleukin 6, and tumor necrosis factor- $\alpha$ , are involved in the pathogenesis of osteoporosis. In addition, estrogen deficiency has been associated with an

increased production of interleukin 7, leading to T-cell activation in bone. These T cells produce RANKL and tumor necrosis factor- $\alpha$  that stimulate osteoclastogenic activity [6]. The gut microbiota might also increase the frequency of T cells in the bone marrow, thereby promoting the expression of inflammatory cytokines in bone and activating osteoclastogenesis [7].

---

## Osteoporosis Treatment and Influence on Bone Metabolism

The aim of osteoporosis treatment is the prevention of fragility fractures. This includes non-pharmacological interventions,  $Ca^{2+}$  and vitamin D supplements, and drugs with proven anti-fracture efficacy. The choice of first-line treatment greatly depends on the patient and his/her personal and disease characteristics, including age, comorbidities, fracture risk, expected adherence and potential adverse effects, and others.

## Nutrition and Physical Activity

Reduced intake of  $Ca^{2+}$ , proteins, and vitamin D contributes to osteoporosis. Thus, an adequate  $Ca^{2+}$  supply is needed to prevent secondary hyperparathyroidism, if necessary with dietary and  $Ca^{2+}$  supplements. Vitamin D deficiency is very frequent [8] and hampers the clinical benefits of anti-resorbing therapies [9]. Vitamin D supplements reduce the risk of fracture and propensity to falls by their effect on muscles [10] and prevent secondary hyperparathyroidism. Daily dietary sources (even if rich in oily fish) and sun exposure fail to provide enough vitamin D in patients with vitamin D insufficiency, and supplements are needed to achieve a sufficient circulating level of calcidiol ( $>50$  nmol/l). To improve vitamin D absorption, it should be taken with a fat-rich diet, such as milk, or at the end of the meal.

Correction of poor protein intake can restore an altered growth hormone-IGF-1 axis and improve BMD as well as muscle mass and strength. Promotion of physical activity has a positive impact on bone loss and prevention of



falls, mechanical stimuli targeting osteocytes, and muscle strength. Mechanical loading also prevents the expression of sclerostin, a negative regulator of bone formation produced by osteocytes, inducing new bone formation.

## Anti-osteoporotic Drugs

The primary objective of all anti-osteoporotic drugs is to reduce fracture risk, by improving bone strength. Except for hormone replacement therapy (HRT), the efficacy of all drugs was tested in patients receiving a combination of  $\text{Ca}^{2+}$  and vitamin D (Table 1) [11]. HRT was commonplace in the treatment or prevention of osteoporosis, but its indication is now reduced because of an increased risk of breast cancer (see chapter “[Breast cancer](#)”), cardiovascular disease (see chapter “[Atherosclerotic heart disease](#)”), and stroke (see chapter “[Stroke](#)”) induced by the estrogens [12].

Most of the more recent drugs (Table 1) decrease bone resorption: bisphosphonates, denosumab, and SERMs (selective estrogen-receptor modulators).

Bisphosphonates were the first of these and are still the most common treatment. They inhibit osteoclastic resorption. Selective estrogen-receptor modulators, nonsteroidal agents that bind to estrogen receptors (see chapter “[Breast cancer](#)”), act as estrogen agonists on bone. More recently, denosumab was developed, a humanized

monoclonal antibody that selectively inhibits the RANKL. The only bone anabolic agent (promoting bone formation) for the treatment of osteoporosis is truncated or full-length PTH. Teriparatide, the first 34 amino acids of human PTH, was the first anabolic agent based on the effects of PTH on bone turnover that depend on the pattern and duration of its elevation. While hyperparathyroidism is associated with increased bone resorption, daily administration of teriparatide results in upregulation of bone formation on the skeleton. Strontium ranelate reduces fracture risk both by inhibiting bone resorption and stimulating bone formation, through various mechanisms not yet fully elucidated.

---

## Perspectives

Osteoporosis is a common disorder associated with high morbidity and increased mortality, which can be easily diagnosed based on clinical risk factors and BMD assessment. Its prevention is feasible by cost-effective strategies targeting risk factors or drugs modifying bone turnover. With population aging and increased life expectancy, long-term treatment of osteoporosis needs to consider sequential therapeutic strategies. Promising drugs currently under investigation include an oral drug that inhibits the bone resorption enzyme cathepsin K (odanacatib) and anti-sclerostin monoclonal antibodies (romosozumab) that stimulate bone formation by osteoblasts.

**Table 1** Pharmacological agents preventing fracture risk used in postmenopausal osteoporosis

Drug class	Drug molecules	Bone targets and mechanism of action	Effects on Bone remodeling	Side/off-target effects and adverse effects
			Bone resorption	Bone formation
Bisphosphonates	Atenolone, risedronate, ibandronate, zoledronate,	<i>Inhibitors of bone resorption:</i> Inhibit osteoclast activity Induce osteoclast apoptosis	∇∇∇	∇∇∇
SERMs	Raloxifene, bazedoxifene	<i>Inhibitors of bone resorption:</i> Nonsteroidal agents that bind to the estrogen receptor and act as estrogen agonists on bone	∇∇	∇∇
Anti-RANKL monoclonal antibodies	Denosumab	<i>Inhibitors of bone resorption:</i> Humanized monoclonal antibodies binding to RANKL. Prevent the effect of RANKL on osteoclasts differentiation, activation, and survival	∇∇∇	∇
PTH	Teriparatide	<i>Activators of bone formation:</i> Number and activity of osteoblasts <sup>A</sup>	AA	AAA
Strontium ranelate		<i>Mixed effect on bone resorption and formation:</i> Inhibits bone resorption and stimulates bone formation	∇	A

*SERM* selective estrogen-receptor modulator, *RANKL* receptor activator of nuclear factor-κB ligand

Side/off-target effects and adverse effects

Oral: low bioavailability due to low absorption in gastrointestinal (<1 %)

Long-lasting remanent protection of bone

Oesophageal irritation

Flu-like symptoms after intravenous injection

Osteonecrosis of the jaw in patients receiving high doses

Atypical fractures of the femur with long-term use

Risk of invasive breast cancer due to estrogen antagonist effects<sup>∇</sup>

Deep venous thromboembolism<sup>A</sup>

Possible adverse immune effects (dermatological side effects and skin infection)

Hypocalcemia

Possibly associated with osteonecrosis of the jaw and atypical fractures of the femur

Contraindicated in conditions with abnormally increased bone turnover, in patients with prior radiation therapy to the skeleton, skeletal malignancies, or bone metastases

Limited to 24 months (risk of osteosarcoma)

Venous thromboembolism risk<sup>A</sup>

Isolated cases of drug rash with eosinophilia and systemic symptoms

## References

1. World Health Organization (1994) Assessment of fracture risk and its application to screening for postmenopausal osteoporosis. WHO technical report series, no. 843. Report of a WHO Study Group, Geneva
2. Rizzoli R, Bianchi ML, Garabedian M, McKay HA, Moreno LA (2010) Maximizing bone mineral mass gain during growth for the prevention of fractures in the adolescents and the elderly. *Bone* 46:294–305
3. Verschuere S, Gielen E, O'Neill TW, Pye SR, Adams JE, Ward KA, Wu FC, Szulc P, Laurent M, Claessens F, Vanderschueren D, Boonen S (2013) Sarcopenia and its relationship with bone mineral density in middle-aged and elderly European men. *Osteoporos Int* 24:87–98
4. Rizzoli R (2008) Nutrition: its role in bone health. *Best Pract Res Clin Endocrinol Metab* 22:813–829
5. Karsenty G, Gershon MD (2011) The importance of the gastrointestinal tract in the control of bone mass accrual. *Gastroenterology* 141:439–442
6. Clowes JA, Riggs BL, Khosla S (2005) The role of the immune system in the pathophysiology of osteoporosis. *Immunol Rev* 208:207–227
7. Sjögren K, Engdahl C, Henning P, Lerner UH, Tremaroli V, Lagerquist MK, Bäckhed F, Ohlsson C (2012) The gut microbiota regulates bone mass in mice. *J Bone Miner Res* 27:1357–1367
8. Wahl DA, Cooper C, Ebeling PR, Eggersdorfer M, Hilger J, Hoffmann K, Josse R, Kanis JA, Mithal A, Pierroz DD, Stenmark J, Stöcklin E, Dawson-Hughes B (2012) A global representation of vitamin D status in healthy populations. *Arch Osteoporos* 7:155–172
9. Adami S, Giannini S, Bianchi G, Sinigaglia L, Di Munno O, Fiore CE, Minosola S, Rossini M (2009) Vitamin D status and response to treatment in postmenopausal osteoporosis. *Osteoporos Int* 20:239–244
10. Stockton KA, Mengersen K, Paratz JD, Kandiah D, Bennell KL (2011) Effect of vitamin D supplementation on muscle strength: a systematic review and meta-analysis. *Osteoporos Int* 22:859–871
11. Kanis JA, McCloskey EV, Johansson H, Cooper C, Rizzoli R, Reginster JY (2013) European guidance for the diagnosis and management of osteoporosis in postmenopausal women. *Osteoporos Int* 24:23–57
12. Marjoribanks J, Farquhar C, Roberts H, Lethaby A (2012) Long term hormone therapy for perimenopausal and postmenopausal women. *Cochrane Database Syst Rev* (7):CD004143

---

## **Part IV**

### **Joints**

---

# Overview

Jessica Bertrand and Jan Hubert

---

## Anatomy and Physiology of Joints

### Joints Classification

Joints are locations at which two or more bones come together. They are often constructed to allow movement and provide mechanical support. Joints can be classified functionally based on the amount of movement allowed: “synarthroses” are immovable, “amphiarthroses” are slightly movable, and “diarthroses” are freely movable.

Joints can also be classified structurally, describing how the bones connect to each other, as fibrous, cartilaginous, and synovial. Synarthroses are fibrous joints that connect bones without allowing any movement and are found, for example, in the skull and pelvis and at the union of the spinous processes and vertebrae. In cartilaginous joints (amphiarthroses), the bones are attached by cartilage, and they allow for only a little movement, such as in the spine or ribs. Synovial joints, also called diarthroses, are of crucial importance for the skeletal function, as they permit a wider

range of movement. The ends of the opposing skeletal elements in synovial joints are covered with articular cartilage. The spaces between the bones in synovial joints are filled with synovial fluid, which helps to lubricate and protect the cartilage and nourishes the tissues. The joint is surrounded by the synovial membrane and held together by the fibrous joint capsule (that insulates the joints from surrounding tissues) and ligaments (that hold the skeletal elements in place) [1].

Synovial joints can be distinguished again into six different types depending on the mobility and type of movement they allow for: gliding, hinge, pivot, condyloid, saddle, “ball and socket,” and compound joints.

The following passages will describe the different structures of synovial joints, with special emphasis on biochemical processes that play a role during joint homeostasis.

### Joint Formation

A process called endochondral ossification mediates the formation of long bones and thereby the formation of articular joints in arms and legs (see chapter “[Overview](#)” under part “Teeth and bones”). During the differentiation of mesenchymal cells into chondrocytes, the expression pattern of extracellular matrix proteins changes. While the expression of collagen I decreases, chondrocytes start producing collagens II, IX, and XI as well as proteoglycans like aggrecan, link protein, and matrix Gla protein [2]. At the ends of

---

J. Bertrand (✉)  
Institute of Experimental Musculoskeletal  
Medicine IEMM, University Hospital Muenster,  
Domagkstrasse 3, Muenster 48149, Germany  
e-mail: [bertrand@uni-muenster.de](mailto:bertrand@uni-muenster.de)

J. Hubert  
Klinik und Poliklinik für Orthopädie,  
Universitätsklinikum Hamburg-Eppendorf,  
Martinistrasse 52, Hamburg 20246, Germany  
e-mail: [j.hubert@uke.de](mailto:j.hubert@uke.de)

the bones, this composition of cartilage matrix is retained, and the chondrocytes do not differentiate any further and form the articular cartilage.

In the bone-forming parts of the embryonic cartilage, chondrocytes differentiate further and become hypertrophic. As part of their hypertrophic differentiation, they start to express collagen X. With beginning bone formation, cartilage undergoes vascularization [2, 3], and the extracellular matrix gets mineralized. Subsequently, a continuous cycle of bone remodeling starts, driven by resorbing osteoclasts and bone-forming osteoblasts (see chapter “[Overview](#)” under part “Teeth and bones”).

During osteoarthritis (see chapter “[Osteoarthritis](#)”), however, articular chondrocytes also undergo prehypertrophic to hypertrophic maturation. This differentiation is accompanied by an increase in expression of certain marker genes, such as alkaline phosphatase [4] and collagen X [5], with subsequent mineralization of the diseased cartilage [5].

---

## Joint-Specific Pathways and Processes

### Bone

The aforementioned balance between bone formation and resorption is regulated by macrophage colony-stimulating factor (M-CSF) and receptor activator of nuclear factor- $\kappa$ B ligand (RANKL) [6, 7]. M-CSF is constitutively expressed in osteoblasts and binds to receptors on monocytes, macrophages, and osteoclasts, thereby inducing osteoclast maturation and differentiation. RANKL, however, is mainly expressed in osteoblasts in response to factors that stimulate bone resorption, such as parathyroid hormone and calcitriol. RANKL binds to its receptor on osteoclast precursors, initiating their maturation. Bone resorption induced by RANKL can be blocked by osteoprotegerin (OPG), which is also secreted by osteoblasts and osteogenic stromal stem cells (see chapter “[Overview](#)” under part “Teeth and bones”).

The Wnt signaling pathways (canonical and noncanonical) play a central role in bone

remodeling in both physiological and pathological conditions. Canonical Wnt signaling promotes differentiation of osteoblast precursor cells (Fig. 1) [8, 9]. Additionally, this pathway suppresses bone resorption by shifting the RANKL/OPG ratio towards OPG in mature osteoblasts [10]. However, the activation of the noncanonical pathway enhances the RANKL-induced osteoclast formation [11].

### Cartilage

Cartilage is a flexible form of connective tissue. The predominant form is hyaline cartilage, named after its glassy, translucent appearance. It is commonly associated with the skeletal system, as it covers the bones and represents the articular cartilage in joints. It is also found between the ribs and the sternum or breastplate, in the trachea and bronchi of the lungs, in the ear, and in the larynx or voice box. Macroscopically, articular cartilage can be divided into the superficial zone, the transitional zone, the radial zone, and the calcified cartilage zone, where the cartilage interfaces with the bone (Fig. 1) [12]. These zones are characterized by a distinct organization of the collagen network, as well as by differences in the amounts and types of proteoglycans. Type II collagen is the principal molecular component in healthy articular cartilage, but collagens III, VI, IX–XII, and XIV all contribute in smaller amounts to the mature matrix [13–15], whereas the collagens IX, X, and XI are specific for cartilage tissue. The main proteoglycan is aggrecan. It is important for the biomechanical properties of articular cartilage because it builds a hydrated gel structure due to its interaction with hyaluronan and link protein. Due to these properties of aggrecan, the cartilage is a rigid and reversibly deformable tissue that has the ability to resist compression.

The only cells found in cartilage are chondrocytes. In adult cartilage, the chondrocytes remain resting in a non-proliferating state, but display moderate metabolic activity and the ability to maintain the surrounding matrix.

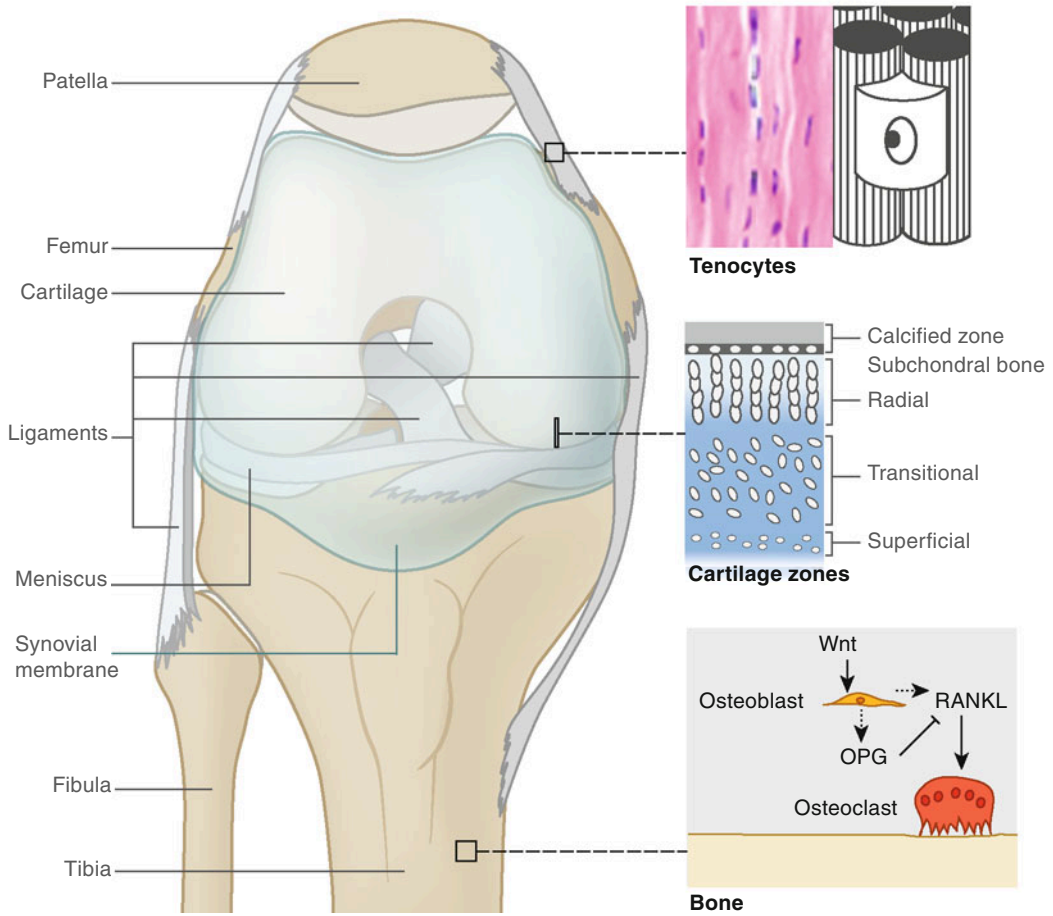

**Fig. 1** Macroscopic and microscopic diagram of the anatomy of the human knee. The knee is a synovial joint; its anatomical structures, bones (patella, femur, fibula, and tibia), ligaments, and meniscus are shown (to the left), including the different cell compartments. The inserts to

the right depict magnifications of important structures and tissue-specific pathways showing, from top to bottom, tendon, cartilage, and bone. Please note that the cartilage zones do not extend along the cartilage but into it, toward the femur, as indicated by the small gray box

### Ligaments and Tendons

Tendons and ligaments are tough, fiber-rich connective tissues characterized by their excellent tensile strength. Both consist of fibroblasts (in tendons called tenocytes), which have long extensions that are located in rows in between the collagen fibrils, and the proteoglycan matrix that is synthesized by the fibroblasts into the intercellular space (Fig. 1). The collagen fibrils consist primarily of collagen type I and very small amounts of elastin and other collagens (types II–V, IX, and X).

Tendons are responsible for the power transmission as well as for the stabilization of joints and skeletal elements. In tendons the collagenous fibers, which are parallel and oriented in tensile direction, are divided by septa of loose connective tissue (peritendineum) to separate bundles. On the outside, the tendon is enveloped by a white fibrous sheath called epitendineum, which merges into the perimysium, the connective tissue surrounding the muscle.

Ligaments mediate the guidance of joints and skeletal elements. They are coarse, fiber-rich connective tissues that connect different skeletal

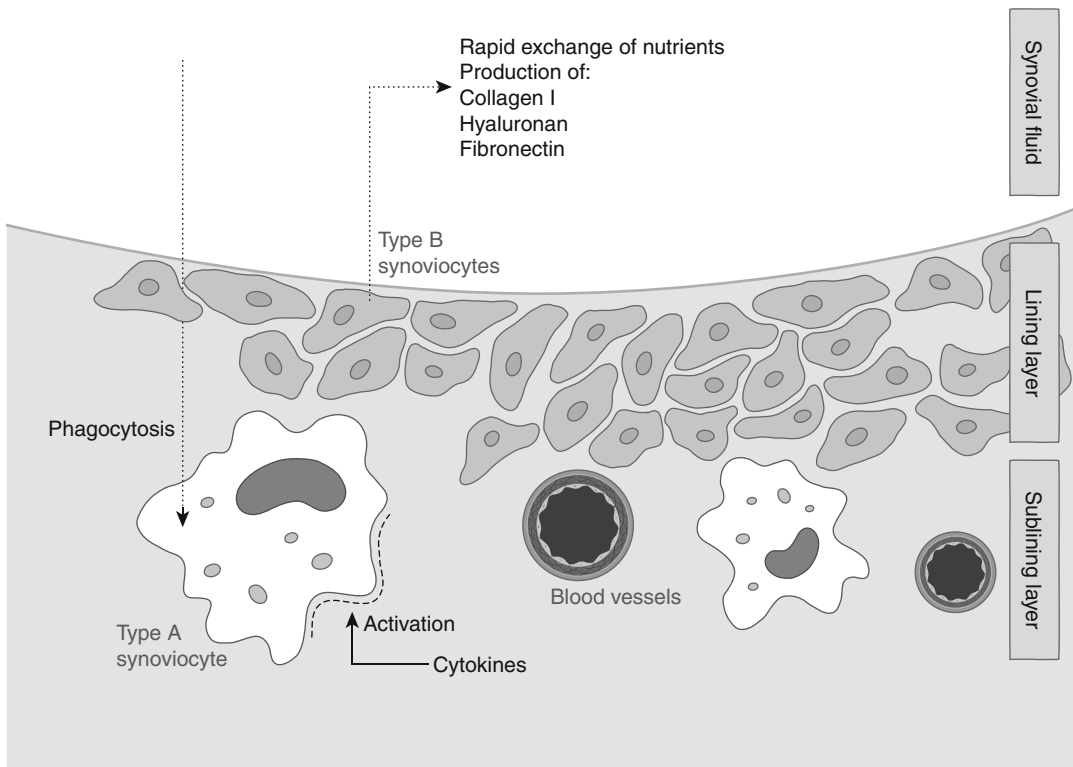

**Fig. 2** Schematic view of the synovial membrane (or synovium) and its cell types. Type A synoviocytes are resident macrophages, which are rare in healthy synovium, and type B synoviocytes are fibroblast-like cells. Basal

functions of these cell types are shown in black. The different layers of the synovium are labeled on the right side. As depicted, the sub-lining is extensively vascularized

elements and have mainly stabilizing functions. The histological structure of the ligament is very similar to the structure of tendons.

Damage of these structures due to a trauma commonly leads to an impairment of the joint function and may possibly result in changes of its biomechanical properties and subsequent osteoarthritis (see chapter “[Osteoarthritis](#)”) [16]. Inflammatory processes, like in rheumatoid arthritis (see chapter “[Rheumatoid arthritis](#)”), can cause a chronic damage to the tendons, tendon sheaths, the articular capsule, and the ligaments, thus deforming the joints [17].

## Synovium

The synovial membrane (or synovium, Fig. 2) is specific to synovial joints and seals the synovial fluid from the surrounding tissue. It is only about

four to five cell layers thick and has no basement membrane, which makes it differ significantly from regular epithelium. The composition of the synovium is very variable, but mostly has two layers: the superficial layer of the synovium is called lining layer and can be separated histologically from the more loose network of fibroblast underneath, which is called sub-lining (Fig. 2). It consists of two cell types, fibroblasts and macrophages, which both differ from similar cells in other tissues. The (resident) macrophages are called type A synoviocytes and are rare in healthy synovium. Their main function is phagocytosis of undesirable substances from the synovial fluid, such as cell debris and dead cell tissues. The fibroblast-like type B synoviocytes provide the synovial cavity with lubricating factors and produce components of the extracellular matrix, including hyaluronan, collagens, and fibronectin. The superficial layer is called



lining layer. This layer of cells lacks the basement membrane and thereby facilitates the rapid exchange of nutrients between blood and the synovium.

The sub-lining is intensely vascularized, providing nutrients to the synovium and the avascular cartilage. During rheumatoid arthritis, type B synoviocytes undergo stable activation, meaning that they proliferate more and produce proinflammatory cytokines (see chapter “[Rheumatoid arthritis](#)”).

---

### Inside-In and Outside-In Signaling: Metabolites Affecting the Joints

Several morphogens and growth factors have been implicated in regulating the sensitive homeostasis of resting chondrocytes. Among others, three groups of soluble proteins regulate chondrocyte differentiation in endochondral ossification: bone morphogenetic proteins (BMPs), growth factors, and Wnts [18]. The stimulation of resting chondrocytes with these factors leads to a loss of the resting phenotype and induces hypertrophic differentiation or proliferation of chondrocytes.

As cartilage tissue is avascular and the chondrocytes are isolated inside their lacunae, the communication between chondrocytes in the superficial zone and chondrocytes in the middle and deeper layers occurs through diffusion. Chondrocytes located in the superficial zone of adult cartilage communicate via gap junction channels consisting of connexin 43 and 45 [19].

The synovium plays an important role in the repair process induced by proinflammatory cytokines that are released in response to intra-articular damage [20]. Exposure to proinflammatory cytokines activates type A synoviocytes, which then function as tissue macrophages. The type B synoviocytes are also proposed to play a critical role in the switch from acute inflammation to adaptive immunity, tissue repair, as well as chronic inflammation. During chronic inflammation they can get stably activated, meaning that they fail to switch off their inflammatory program, leading to inappropriate survival and proliferation of type B synoviocytes and retention of leukocytes within the inflamed

tissue. Due to these inflammatory conditions, there is an increase in vascularization of the sub-lining, facilitating the accumulation of immune cells and perpetuating possible autoimmune processes. These processes together lead to hyperplasia of the synovial membrane, and the resulting tissue is called pannus tissue [21].

---

### Final Remarks

The joint does not only make movement possible, but functions as a highly specialized organ. The different compartments work together with an extensive crosstalk. If one part of the joint is damaged or impaired in function, it affects the whole joint, as seen, for example, during osteoarthritis (see chapter “[Osteoarthritis](#)”) or rheumatoid arthritis (see chapter “[Rheumatoid arthritis](#)”).

---

### References

1. Pacifici M, Koyama E, Iwamoto M (2005) Mechanisms of synovial joint and articular cartilage formation: recent advances, but many lingering mysteries. *Birth Defects Res C Embryo Today* 75:237–248
2. DeLise AM, Fischer L, Tuan RS (2000) Cellular interactions and signaling in cartilage development. *Osteoarthritis Cartilage* 8:309–334
3. Olsen BR, Reginato AM, Wang W (2000) Bone development. *Annu Rev Cell Dev Biol* 16:191–220
4. Pfander D, Swoboda B, Kirsch T (2001) Expression of early and late differentiation markers (proliferating cell nuclear antigen, syndecan-3, annexin VI, and alkaline phosphatase) by human osteoarthritic chondrocytes. *Am J Pathol* 159:1777–1783
5. Fuerst M, Bertrand J, Lammers L, Dreier R, Echtermeyer F, Nitschke Y, Rutsch F, Schäfer FK, Niggemeyer O, Steinhagen J, Lohmann CH, Pap T, Rütter W (2009) Calcification of articular cartilage in human osteoarthritis. *Arthritis Rheum* 60:2694–2703
6. Takahashi M, Hong YM, Yasuda S, Takano M, Kawai K, Nakai S, Hirai Y (1988) Macrophage colony-stimulating factor is produced by human T lymphoblastoid cell line, CEM-ON: identification by amino-terminal amino acid sequence analysis. *Biochem Biophys Res Commun* 152:1401–1409
7. Suda T, Takahashi N, Udagawa N, Jimi E, Gillespie MT, Martin TJ (1999) Modulation of osteoclast differentiation and function by the new members of the tumor necrosis factor receptor and ligand families. *Endocr Rev* 20:345–357

8. Kato M, Patel MS, Levasseur R, Lobov I, Chang BH, Glass DA 2nd, Hartmann C, Li L, Hwang TH, Brayton CF, Lang RA, Karsenty G, Chan L (2002) Cbfa1-independent decrease in osteoblast proliferation, osteopenia, and persistent embryonic eye vascularization in mice deficient in Lrp5, a Wnt coreceptor. *J Cell Biol* 157:303–314
9. Clement-Lacroix P, Ai M, Morvan F, Roman-Roman S, Vayssière B, Belleville C, Estrera K, Warman ML, Baron R, Rawadi G (2005) Lrp5-independent activation of Wnt signaling by lithium chloride increases bone formation and bone mass in mice. *Proc Natl Acad Sci U S A* 102:17406–17411
10. Glass DA 2nd, Bialek P, Ahn JD, Starbuck M, Patel MS, Clevers H, Taketo MM, Long F, McMahon AP, Lang RA, Karsenty G (2005) Canonical Wnt signaling in differentiated osteoblasts controls osteoclast differentiation. *Dev Cell* 8:751–764
11. Tu X, Joeng KS, Nakayama KI, Nakayama K, Rajagopal J, Carroll TJ, McMahon AP, Long F (2007) Noncanonical Wnt signaling through G protein-linked PKCdelta activation promotes bone formation. *Dev Cell* 12:113–127
12. Wong M, Carter DR (2003) Articular cartilage functional histomorphology and mechanobiology: a research perspective. *Bone* 33:1–13
13. Poole AR, Kojima T, Yasuda T, Mwale F, Kobayashi M, Laverty S (2001) Composition and structure of articular cartilage: a template for tissue repair. *Clin Orthop Relat Res* 391(Suppl):S26–S33
14. Eyre DR, Muir H (1975) The distribution of different molecular species of collagen in fibrous, elastic and hyaline cartilages of the pig. *Biochem J* 151:595–602
15. Burgeson RE, Hebdan PA, Morris NP, Hollister DW (1982) Human cartilage collagens. Comparison of cartilage collagens with human type V collagen. *J Biol Chem* 257:7852–7856
16. Fleming BC, Hulstyn MJ, Oksendahl HL, Fadale PD (2005) Ligament injury, reconstruction and osteoarthritis. *Curr Opin Orthop* 16:354–362
17. Ash Z, McGonagle D (2011) Joint appendages: the structures which have historically been overlooked in arthritis research and therapy development. *Best Pract Res Clin Rheumatol* 25:779–784
18. Dreier R (2010) Hypertrophic differentiation of chondrocytes in osteoarthritis: the developmental aspect of degenerative joint disorders. *Arthritis Res Ther* 12:216
19. Mayan MD, Carpintero-Fernandez P, Gago-Fuentes R, Martinez-de-Illarduya O, Wang HZ, Valiunas V, Brink P, Blanco FJ (2013) Human articular chondrocytes express multiple gap junction proteins: differential expression of connexins in normal and osteoarthritic cartilage. *Am J Pathol* 182:1337–1346
20. Smith MD, Barg E, Weedon H, Papangelis V, Smeets T, Tak PP, Kraan M, Coleman M, Ahern MJ (2003) Microarchitecture and protective mechanisms in synovial tissue from clinically and arthroscopically normal knee joints. *Ann Rheum Dis* 62:303–307
21. Neumann E, Lefevre S, Zimmermann B, Gay S, Muller-Ladner U (2010) Rheumatoid arthritis progression mediated by activated synovial fibroblasts. *Trends Mol Med* 16:458–468

---

# Osteoarthritis

Camille Roubille, Johanne Martel-Pelletier,  
and Jean-Pierre Pelletier

---

## Introduction to Osteoarthritis

Osteoarthritis (OA) is the most common form of arthritis, affecting 13.9 % of US adults aged 25 and older, totaling 26.9 million [1]. OA is characterized by degradation and loss of articular cartilage, hypertrophic bone changes with osteophyte formation (bony projections along the joint margin), subchondral bone remodeling, and inflammation of the synovial membrane. Other tissues of the joint including the muscles and ligaments are also altered during the OA process.

OA can be triggered by external factors such as trauma and endogenous predisposing factors including age, genetics, and high body mass index. It results in pain, reduced quality of life, and disability necessitating joint replacement in end-stage disease.

Important advances have been made in understanding its pathological processes, and promising new disease-modifying OA drugs (DMOADs) are being developed that will slow the progression of the disease and improve the current symptomatic treatment.

---

## Pathophysiology of Osteoarthritis

OA is a multifactorial disease resulting in the failure of the articular tissues to maintain a homeostatic balance between matrix synthesis and degradation. An initial phase of cartilage remodeling is characterized by edema, followed by degradation and loss of this tissue. These alterations are associated with synovial inflammation and subchondral bone remodeling (Fig. 1).

In cartilage, there is only one type of cell, the chondrocyte, which is responsible for the maintenance of this tissue's extracellular matrix (ECM, see chapter "Overview" under part "Joints"). Early during the OA process, increased biomechanical stress and/or biochemical stimuli can activate the anabolic function of chondrocytes to repair early cartilage damage. Over time, this anabolic attempt fails and leads to an imbalance favoring degradation. This degradation will induce a vicious circle, in which the degradative fragments of ECM proteins (e.g., fibronectin and collagen) induce synovial membrane inflammation, which in turn will produce catabolic and inflammatory factors [2, 3], thus aggravating the OA process. Increasing evidence suggests that in OA there is a cross talk between the cartilage, synovial membrane, and subchondral bone, which sustains the catabolic process [4, 5]. Synovial inflammation, which is suggested to be secondary to the release of cartilage products into the synovial fluid, and subchondral bone remodeling by its release of soluble mediators, affects the cartilage by sustaining its degradation. The

---

C. Roubille • J. Martel-Pelletier • J.-P. Pelletier (✉)  
Osteoarthritis Research Unit,  
University of Montreal Hospital  
Research Centre (CRCHUM),  
900 Saint-Denis, Tour Viger, Montreal,  
QC H2X 0A9, Canada  
e-mail: [camille.roubille@gmail.com](mailto:camille.roubille@gmail.com);  
[jm@martelppetier.ca](mailto:jm@martelppetier.ca); [dr@jppetier.ca](mailto:dr@jppetier.ca)

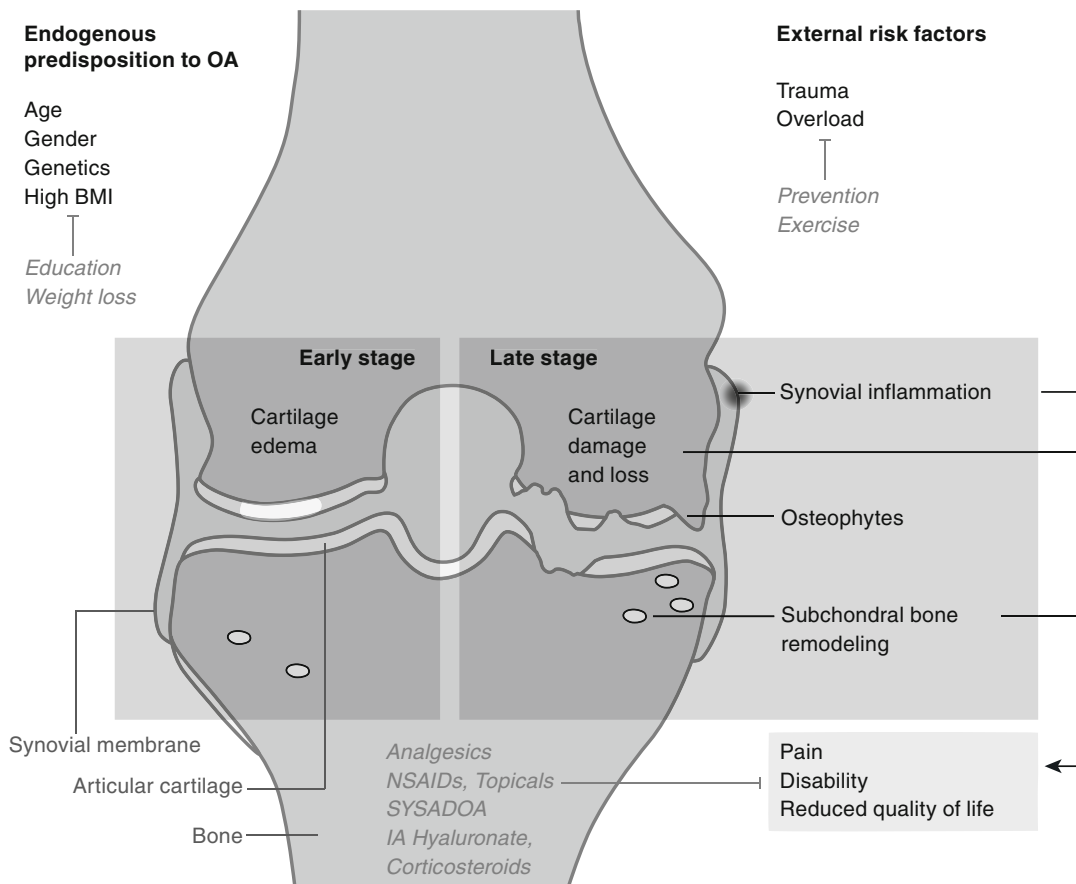
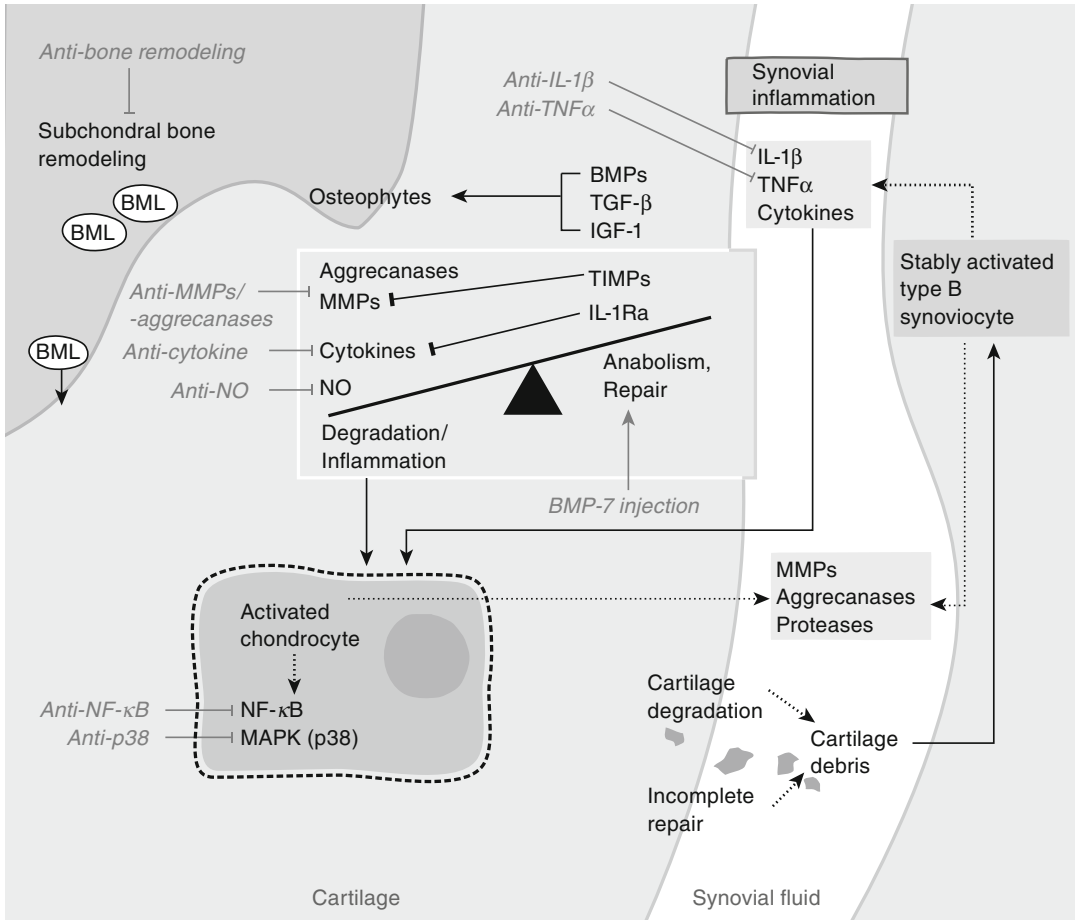

**Fig. 1** A model of global pathophysiology of knee osteoarthritis and of current multimodal management. Osteoarthritis can be triggered by external factors including trauma and endogenous predisposition factors such as age, genetics, and high body mass index (*BMI*). After an initial phase of cartilage edema, cartilage damage and loss occurs, which is associated with synovial inflammation, osteophyte formation, and subchondral bone remodeling. These structural changes generate pain, disability, and

reduced quality of life. Current osteoarthritis management consists of education (on osteoarthritis, its progression, and its risk factors), weight loss (if necessary), prevention of injury, exercise, and pharmacological symptomatic treatment. Common treatments include acetaminophen (paracetamol), nonsteroidal anti-inflammatory drugs (*NSAIDs*), opioids, intra-articular (*IA*) administration of hyaluronate and corticosteroids, and symptomatic slow-acting drugs (*SYSADOA*)

chondrocytes (autocrine pathway) and synovio-  
cytes (see chapter “**Overview**” under part  
“**Joints**”) in the synovial membrane (paracrine  
pathway) release catabolic and proinflammatory  
substances. These include proteinases, e.g.,  
matrix metalloproteinases (*MMPs*) and aggrecan-  
ases, and inflammatory cytokines, including  
interleukin (*IL*)-1 $\beta$  and tumor necrosis factor  $\alpha$   
(*TNF $\alpha$* ), which enhance the synthesis of protein-  
ases and other catabolic factors to degrade the  
ECM of the articular tissues. Soon, these factors  
overwhelm endogenous inhibitors, such as tissue

inhibitors of *MMPs* (*TIMPs*) and proinflamma-  
tory cytokine inhibitors including the *IL*-1 $\beta$   
receptor antagonist (Fig. 2). Additionally, in *OA*,  
the loss of integrity of the osteochondral junc-  
tion is associated with microcracks and the invasion  
of articular cartilage by vascular channels origi-  
nating from the subchondral bone, supporting the  
molecular cross talk between the subchondral  
bone and the cartilage. Continued ECM degrada-  
tion in the articular tissues results, preventing the  
cartilage from withstanding normal mechanical  
factors.



**Fig. 2** A model of cross talk between cartilage, synovial membrane, and subchondral bone leading to an imbalance favoring articular tissue degradation in knee osteoarthritis. Excessive production of proteases such as matrix metalloproteinases (*MMPs*) and aggreganases, nitric oxide (*NO*), and inflammatory cytokines, such as interleukin-1 $\beta$  (*IL-1 $\beta$* ) and tumor necrosis factor  $\alpha$  (*TNF $\alpha$* ) by the chondrocyte contributes to the degradation of articular tissue including the cartilage. This induces a vicious circle in which the cartilage fragments activate synoviocytes (see chapter “[Overview](#)” under part “[Joints](#)”), resulting in enhanced cartilage degradation and synovial

inflammation. The attempt to repair, which could occur via growth factors such as bone morphogenetic proteins (*BMPs*) and transforming growth factor  $\beta$  (*TGF- $\beta$* ), fails to achieve a complete repair of the extracellular matrix. Disease-modifying osteoarthritis drugs, such as inhibitors of *MMPs* and aggreganases, anti-cytokine therapy, anti-bone remodeling, anti-nuclear factor- $\kappa$ B (*NF- $\kappa$ B*), and anti-mitogen-activated protein kinase (*MAPK*), have been developed, which aim to inhibit these factors and pathways. *BML* bone marrow lesion, *IGF-1* insulin-like growth factor 1, *IL-1Ra* interleukin-1 $\beta$  receptor antagonist, *TIMPs* tissue inhibitors of metalloproteinases

## Osteoarthritis Management

A multimodal approach combining non-pharmacological and pharmacological treatment (Fig. 1) [6] is at present the best option for OA management. However, current options are symptomatic treatments, which mostly aim

at reducing joint pain. They are classified into rapid- or slow-acting symptomatic agents, and some of the slow-acting symptomatic drugs may contribute to slow the natural progression of joint structural damage. When combined approaches are unsuccessful, surgical treatments may be considered.

## Non-pharmacological Treatment

The combination of education, improvement of muscle strength, and weight loss (if overweight) are reported to be joint protective and recommended [7], as are orthotic (joint-stabilizing) devices and prevention of injury.

## Pharmacological Treatment: Rapid-Acting Symptomatic Agents

The rapid-acting symptomatic treatments for OA consist mainly of analgesics and nonsteroidal anti-inflammatory drugs (NSAIDs).

Acetaminophen (paracetamol) remains the first-line therapeutic agent for OA [6] because of its low cost, efficacy, and safety profile. Opioids have become more widely prescribed (often in combination with acetaminophen), especially for OA patients who experience lack of efficacy, contraindications, or intolerance to NSAIDs [6] and those who cannot undergo total joint arthroplasty because of comorbidities contraindicating surgery and anesthesia [7]. However, opioids show several, sometimes severe, adverse events, resulting from binding of opioids to  $\delta$ ,  $\kappa$ , and  $\mu$  receptors that also cause analgesia, including sedation, vomiting, and respiratory depression. Another analgesic, duloxetine, may improve knee pain as well as function [8]. Duloxetine is a selective serotonin and norepinephrine reuptake inhibitor. These neurotransmitters are involved in the mediation of endogenous descending inhibitory pain pathways and central sensitization; in chronic pain states, their inhibitory effect is reduced or lost and duloxetine increases their availability and activity [9]. The main adverse events include nausea, constipation, and hyperhidrosis (increased sweating).

A second class of rapid symptomatic treatments that aim to block or reduce joint inflammation is nonselective NSAIDs (such as diclofenac) and cyclooxygenase-2 (COX-2) inhibitors, also named coxibs (such as celecoxib). These are recommended for patients who are unresponsive to acetaminophen, preferentially during inflammatory flares [6]. The use of NSAIDs is limited by gastrointestinal, renal, and cardiovascular side

effects, which increase with age due to comorbidities. Coxibs demonstrate fewer gastrointestinal complications than nonselective NSAIDs but pose a potential cardiovascular risk [10]. Coxibs inhibit prostacyclin production (by COX-2), but do not inhibit thromboxane A<sub>2</sub> release (from platelets, formed by COX-1). This potentially explains the coxib-related cardiovascular risk as such an imbalance could create continued thromboxane A<sub>2</sub> production, thus increasing the risk of thrombosis. Another explanation could be that some coxibs have been found to increase blood pressure. NSAIDs can be used orally or topically with similar efficacy [11]; however, topical application shows fewer gastrointestinal complications but possible local skin reactions.

Corticosteroids are potent anti-inflammatory drugs that inhibit, among other factors, phospholipase A<sub>2</sub>, reducing the release of proinflammatory phospholipids. Intra-articular corticosteroid injection is recommended for OA inflammatory flares [6].

Hyaluronic acid is a glycosaminoglycan component of ECM and synovial fluid. It is involved in the maintenance of joint homeostasis and its concentration is reduced in OA patients. Intra-articular hyaluronic acid injection (viscosupplementation) is recommended for knee OA patients with an inadequate response to initial therapy [7], despite possible induced transient pain and swelling at the injection site [12]. Compared with intra-articular corticosteroids, viscosupplementation has a delayed but prolonged effect [12].

## Pharmacological Treatment: Slow-Acting Symptomatic Drugs

Among the symptomatic slow-acting drugs for OA are glucosamine and chondroitin sulfate, which demonstrate a pain relief effect. Glucosamine sulfate is a substrate for the formation of glycosaminoglycans and shows a protective structural effect [13]. Chondroitin sulfate, a sulfated glycosaminoglycan, improves joint swelling and delays disease progression [13, 14].

Diacerein, an inhibitor of IL-1 $\beta$  and some proteases, is effective in knee [15] and hip OA [16].

Diarrhea is the most frequent adverse event, which likely occurs due to prostaglandin synthesis induced by rhein, the active metabolite of diclofenac, leading to an increase in gut motility.

Treatment with avocado-soybean unsaponifiables reduces pain in knee and hip OA persistently, and the effect is prolonged even after treatment discontinuation [17, 18]. Inhibition of IL-1 $\beta$  and MMPs has been proposed as potential mechanisms of action.

---

## Disease-Modifying Osteoarthritis Drugs

Currently, several classes of DMOADs are in development or tested in clinical trials (Fig. 2).

### Targeting Cartilage Catabolism and Anabolism

MMP inhibitors aim to block ECM degradation. One such drug, doxycycline, showed only a minimal structural benefit and no effect on pain in a clinical trial [19]. An inhibitor of inducible NO synthase (cindunostat) revealed a reduction in joint space narrowing in mild OA in the first year [20]. Finally, intra-articular injection of growth factors such as bone morphogenetic protein 7 (BMP7) aims to repair OA cartilage.

### Targeting Synovial Inflammation by Anti-cytokine Therapy

Blockade of inflammatory cytokines focuses on IL-1 $\beta$  and TNF $\alpha$ . Other potential targets include IL-6, nuclear factor- $\kappa$ B (NF- $\kappa$ B), and mitogen-activated protein kinase (MAPK), as they are part of the inflammation cascade in OA. Intra-articular administration of the IL-1 $\beta$  receptor antagonist anakinra shows controversial results with regard to symptoms [21], probably due to the short half-life of the drug and the protocol used for the clinical studies so far. Moreover, two antibodies against TNF $\alpha$  (adalimumab, infliximab) were shown to relieve symptoms of

hand [22] and knee OA [23], but the results are still controversial [24].

### Targeting Subchondral Bone Remodeling

Strontium ranelate inhibits bone resorption in subchondral bone [25]. This results from decreased differentiation and resorptive activity of osteoclasts and increased osteoclast apoptosis [26]. Strontium ranelate reduces the progression of spinal [27] and knee OA, as assessed in a Phase III trial by both X-rays [28] and MRI [29].

Risedronate, a bisphosphonate with anti-resorptive properties, preserves the structural integrity of the subchondral bone [30], but in a Phase III clinical trial, no significant effect was found on the Western Ontario and McMaster Universities Arthritis Index (WOMAC) or radiographic progression in knee OA [31].

In vitro, calcitonin reduces collagen degradation by inhibiting the expression and activity of MMPs in chondrocytes [32]. Oral and nasal applications of this thyroid hormone involved in calcium homeostasis are currently being tested [33]. Recently, a Phase III clinical trial was terminated early, probably due to an imbalance in prostate cancer events in male subjects [34].

Vitamin D supplementation in one study did not show any symptom or DMOAD benefits [35]. However, another clinical trial evaluating whether vitamin D supplementation can slow knee OA progression is ongoing [36].

A Phase III study evaluating the recombinant human FGF-18 in patients with knee OA is also currently underway [37].

---

## Perspectives

OA management is based on a wide spectrum of therapeutic options to relieve pain and to try to delay progression. The focus is now on the development of DMOADs that could be associated with conventional therapy to provide a more effective treatment, which remains a huge unmet medical need worldwide given that OA prevalence is likely to increase with the aging population.



## References

- Lawrence RC, Felson DT, Helmick CG, Arnold LM, Choi H, Deyo RA, Gabriel S, Hirsch R, Hochberg MC, Hunder GG, Jordan JM, Katz JN, Kremers HM, Wolfe F (2008) Estimates of the prevalence of arthritis and other rheumatic conditions in the United States. Part II. *Arthritis Rheum* 58:26–35
- Martel-Pelletier J, Lajeunesse D, Pelletier JP (2005) Etiopathogenesis of osteoarthritis. In: Koopman WJ, Moreland LW (eds) *Arthritis & allied conditions a textbook of rheumatology*, 15th edn. Lippincott, Williams & Wilkins, Baltimore, pp 2199–2226
- Martel-Pelletier J, Boileau C, Pelletier JP, Roughley P (2008) Cartilage in normal and osteoarthritis conditions. In: Pap T (ed) *Best practice & research clinical rheumatology*, vol 22. Rapid Medical Media, East Sussex, pp 351–384
- Martel-Pelletier J, Lajeunesse D, Pelletier JP (2007) Subchondral bone and osteoarthritis progression: a very significant role. In: Buckwalter JA, Lotz M, Stoltz JF (eds) *Osteoarthritis, inflammation and degradation: a continuum*, 1st edn. IOS Press, Amsterdam, pp 206–218
- Martel-Pelletier J, Pelletier JP (2010) Is osteoarthritis a disease involving only cartilage or other articular tissues? *Eklemler Hastalik Cerrahisi* 21:2–14
- Zhang W, Moskowitz RW, Nuki G, Abramson S, Altman RD, Arden N, Bierma-Zeinstra S, Brandt KD, Croft P, Doherty M, Dougados M, Hochberg M, Hunter DJ, Kwoh K, Lohmander LS, Tugwell P (2008) OARSI recommendations for the management of hip and knee osteoarthritis, Part II: OARSI evidence-based, expert consensus guidelines. *Osteoarthritis Cartilage* 16:137–162
- Hochberg MC, Altman RD, April KT, Benkhalti M, Guyatt G, McGowan J, Towheed T, Welch V, Wells G, Tugwell P (2012) American College of Rheumatology 2012 recommendations for the use of nonpharmacologic and pharmacologic therapies in osteoarthritis of the hand, hip, and knee. *Arthritis Care Res (Hoboken)* 64:455–474
- Hochberg MC, Wohlreich M, Gaynor P, Hanna S, Risser R (2012) Clinically relevant outcomes based on analysis of pooled data from 2 trials of duloxetine in patients with knee osteoarthritis. *J Rheumatol* 39:352–358
- Skljarevski V, Zhang S, Iyengar S, D'Souza D, Alaka K, Chappell A, Wernicke J (2011) Efficacy of duloxetine in patients with chronic pain conditions. *Curr Drug Ther* 6:296–303
- Trelle S, Reichenbach S, Wandel S, Hildebrand P, Tschannen B, Villiger PM, Egger M, Juni P (2011) Cardiovascular safety of non-steroidal anti-inflammatory drugs: network meta-analysis. *BMJ* 342:c7086
- Underwood M, Ashby D, Cross P, Hennessy E, Letley L, Martin J, Mt-Isa S, Parsons S, Vickers M, Whyte K (2008) Advice to use topical or oral ibuprofen for chronic knee pain in older people: randomised controlled trial and patient preference study. *BMJ* 336:138–142
- Bellamy N, Campbell J, Robinson V, Gee T, Bourne R, Wells G (2005) Viscosupplementation for the treatment of osteoarthritis of the knee. *Cochrane Database Syst Rev* (2):CD005321
- Lee YH, Woo JH, Choi SJ, Ji JD, Song GG (2010) Effect of glucosamine or chondroitin sulfate on the osteoarthritis progression: a meta-analysis. *Rheumatol Int* 30:357–363
- Wildi LM, Raynauld JP, Martel-Pelletier J, Beaulieu A, Bessette L, Morin F, Abram F, Dorais M, Pelletier JP (2011) Chondroitin sulphate reduces both cartilage volume loss and bone marrow lesions in knee osteoarthritis patients starting as early as 6 months after initiation of therapy: a randomised, double-blind, placebo-controlled pilot study using MRI. *Ann Rheum Dis* 70:982–989
- Pelletier JP, Yaron M, Haraoui B, Cohen P, Nahir MA, Choquette D, Wigler I, Rosner IA, Beaulieu AD (2000) Efficacy and safety of diacerein in osteoarthritis of the knee: a double-blind, placebo-controlled trial. The Diacerein Study Group. *Arthritis Rheum* 43:2339–2348
- Dougados M, Nguyen M, Berdah L, Mazieres B, Vignon E, Lequesne M, ECHODIAH Investigators Study Group (2001) Evaluation of the structure-modifying effects of diacerein in hip osteoarthritis: ECHODIAH, a three-year, placebo-controlled trial. Evaluation of the Chondromodulating Effect of Diacerein in OA of the Hip. *Arthritis Rheum* 44:2539–2547
- Maheu E, Mazieres B, Valat JP, Loyau G, Le Loet X, Bourgeois P, Grouin JM, Rozenberg S (1998) Symptomatic efficacy of avocado/soybean unsaponifiables in the treatment of osteoarthritis of the knee and hip: a prospective, randomized, double-blind, placebo-controlled, multicenter clinical trial with a six-month treatment period and a two-month followup demonstrating a persistent effect. *Arthritis Rheum* 41:81–91
- Maheu E, Cadet C, Marty M, Moysse D, Kerloch I, Coste P, Dougados M, Mazieres B, Spector TD, Halhol H, Grouin JM, Lequesne M (2014) Randomised, controlled trial of avocado-soybean unsaponifiable (Piascledine) effect on structure modification in hip osteoarthritis: the ERADIAS study. *Ann Rheum Dis* 73:376–384
- Nuesch E, Rutjes AW, Trelle S, Reichenbach S, Juni P (2009) Doxycycline for osteoarthritis of the knee or hip. *Cochrane Database Syst Rev* (4):CD007323
- Hellio le Graverand MP, Clemmer RS, Redifer P, Brunell RM, Hayes CW, Brandt KD, Abramson SB, Manning PT, Miller CG, Vignon E (2013) A 2-year randomised, double-blind, placebo-controlled, multicentre study of oral selective iNOS inhibitor, cindunistat (SD-6010), in patients with symptomatic osteoarthritis of the knee. *Ann Rheum Dis* 72:187–195
- Chevalier X, Goupille P, Beaulieu AD, Burch FX, Bensen WG, Conrozier T, Loeuille D, Kivitz AJ, Silver D, Appleton BE (2009) Intraarticular injection of anakinra in osteoarthritis of the knee: a multicenter, randomized, double-blind, placebo-controlled study. *Arthritis Rheum* 61:344–352



22. Fioravanti A, Fabbroni M, Cerase A, Galeazzi M (2009) Treatment of erosive osteoarthritis of the hands by intra-articular infliximab injections: a pilot study. *Rheumatol Int* 29:961–965
23. Maksymowych WP, Russell AS, Chiu P, Yan A, Jones N, Clare T, Lambert RG (2012) Targeting tumour necrosis factor alleviates signs and symptoms of inflammatory osteoarthritis of the knee. *Arthritis Res Ther* 14:R206
24. Verbruggen G, Wittoek R, Vander Cruyssen B, Elewaut D (2012) Tumour necrosis factor blockade for the treatment of erosive osteoarthritis of the interphalangeal finger joints: a double blind, randomised trial on structure modification. *Ann Rheum Dis* 71: 891–898
25. Tat SK, Pelletier JP, Mineau F, Caron J, Martel-Pelletier J (2011) Strontium ranelate inhibits key factors affecting bone remodeling in human osteoarthritic subchondral bone osteoblasts. *Bone* 49:559–567
26. Martel-Pelletier J, Wildi LM, Pelletier JP (2012) Future therapeutics for osteoarthritis. *Bone* 51:297–311
27. Bruyere O, Delferriere D, Roux C, Wark JD, Spector T, Devogelaer JP, Brixen K, Adami S, Fechtenbaum J, Kolta S, Reginster JY (2008) Effects of strontium ranelate on spinal osteoarthritis progression. *Ann Rheum Dis* 67:335–339
28. Reginster JY, Badurski J, Bellamy N, Bensen W, Chapurlat R, Chevalier X, Christiansen C, Genant H, Navarro F, Nasonov E, Sambrook PN, Spector TD, Cooper C (2013) Efficacy and safety of strontium ranelate in the treatment of knee osteoarthritis: results of a double-blind, randomised placebo-controlled trial. *Ann Rheum Dis* 72:179–186
29. Pelletier J-P, Roubille C, Raynauld JP, Abram F, Dorais M, Delorme P, Martel-Pelletier J (2013) Disease modifying effect of strontium ranelate in the Phase III knee osteoarthritis study SEKOIA using quantitative magnetic resonance imaging: reduction in bone marrow lesions protects against cartilage loss. *Ann Rheum Dis*. doi: 10.1136/annrheumdis-2013-203989
30. Buckland-Wright JC, Messent EA, Bingham CO 3rd, Ward RJ, Tonkin C (2007) A 2 yr longitudinal radiographic study examining the effect of a bisphosphonate (risedronate) upon subchondral bone loss in osteoarthritic knee patients. *Rheumatology (Oxford)* 46:257–264
31. Bingham CO 3rd, Buckland-Wright JC, Garnero P, Cohen SB, Dougados M, Adami S, Clauw DJ, Spector TD, Pelletier JP, Raynauld JP, Strand V, Simon LS, Meyer JM, Cline GA, Beary JF (2006) Risedronate decreases biochemical markers of cartilage degradation but does not decrease symptoms or slow radiographic progression in patients with medial compartment osteoarthritis of the knee: results of the two-year multinational knee osteoarthritis structural arthritis study. *Arthritis Rheum* 54:3494–3507
32. Sondergaard BC, Wulf H, Henriksen K, Schaller S, Oestergaard S, Qvist P, Tanko LB, Bagger YZ, Christiansen C, Karsdal MA (2006) Calcitonin directly attenuates collagen type II degradation by inhibition of matrix metalloproteinase expression and activity in articular chondrocytes. *Osteoarthritis Cartilage* 14:759–768
33. Esenyel M, Icagasioglu A, Esenyel CZ (2013) Effects of calcitonin on knee osteoarthritis and quality of life. *Rheumatol Int* 33:423–427
34. Nordic Bioscience A/S; Novartis. Efficacy and safety of oral salmon calcitonin in patients with knee osteoarthritis (OA 2 Study). In: ClinicalTrials.gov [Internet]. Bethesda (MD): National Library of Medicine (US). 2000- [cited 2014 Mar 5]. Available from <http://clinicaltrials.gov/show/NCT00704847NLMIdentifier:NCT00704847>
35. McAlindon T, LaValley M, Schneider E, Nuite M, Lee JY, Price LL, Lo G, Dawson-Hughes B (2013) Effect of vitamin D supplementation on progression of knee pain and cartilage volume loss in patients with symptomatic osteoarthritis: a randomized controlled trial. *JAMA* 309:155–162
36. Cao Y, Jones G, Cicuttini F, Winzenberg T, Wluka A, Sharman J, Nguo K, Ding C (2012) Vitamin D supplementation in the management of knee osteoarthritis: study protocol for a randomized controlled trial. *Trials* 13:131
37. EMD Serono; Nordic Bioscience Clinical Development AS, Herlev Denmark. A study to investigate the safety and effectiveness of different doses of sprifermin (AS902330) in patients with osteoarthritis of the knee (FORWARD). In: ClinicalTrials.gov [Internet]. Bethesda (MD): National Library of Medicine (US). 2000- [cited 2014 Mar 5]. Available from <http://clinicaltrials.gov/show/NCT01919164NLMIdentifier:NCT01919164>

---

# Rheumatoid Arthritis

Marianna Meroni, Elena Bernero,  
and Maurizio Cutolo

---

## Introduction to Rheumatoid Arthritis

Rheumatoid arthritis (RA) is a chronic and systemic musculoskeletal autoimmune disease, with extra-articular organ involvement, characterized by an imbalance in the neuroendocrine-immune (NEI) system.

The prevalence of RA is suggested to range from 0.5 to 1 % in the world population. In addition, women are more frequently affected. RA is characterized by a chronic inflammatory process of body joints, with a usual symmetrical, centripetal pattern (starting from peripheral, small joints, and gradually involving major joints). Joint inflammation leads to synovial hypertrophy and juxta-articular bone erosion. The phlogistic process manifests both locally (in joints) and systemically (affecting also lung, heart, kidney, and other organs and tissues), causing symptoms like fever, weight loss, and anorexia. Efforts to understand the pathophysiology of these manifestations identified a proinflammatory cytokine network as a leading factor in RA. Tumor necrosis factor  $\alpha$  (TNF $\alpha$ ) is a major inflammatory mediator in RA, and its isolation has

formed the basis of early RA treatments. Other important proinflammatory cytokines include interleukins (ILs) like IL-1, IL-2, IL-6, and IL-17, transforming growth factors  $\alpha$  and  $\beta$ , and interferon  $\gamma$ .

It is known since the nineteenth century that pregnancy improves RA clinical manifestations, and since 1950, correlations between inflammation and steroid hormones, particularly cortisol and sex hormones, have been suggested [1, 2].

In addition, autoimmune diseases in general present a higher incidence in women in reproductive ages, when sex hormone levels are higher, even if advanced-age cases of autoimmune diseases are partially explained by altered peripheral metabolism of sex hormones [3].

Furthermore, by observing the circadian undulation of symptoms in autoimmune diseases, a link between circadian rhythms of the central nervous system, endocrine systems, and immunologically mediated phenomena becomes evident (Fig. 1) [4].

---

## Pathophysiology of Rheumatoid Arthritis and Metabolic Alterations

An integrated network of the nervous, endocrine, and immune systems is now termed as neuroendocrine-immune (NEI) concept.

The NEI system is mainly constituted of the hypothalamic-pituitary-adrenal (HPA) axis, the hypothalamic-pituitary-gonadal axis, and other complex systems such as the vitamin D endocrine system.

---

M. Meroni • E. Bernero • M. Cutolo (✉)  
Research Laboratory and Academic  
Division of Clinical Rheumatology,  
Department of Internal Medicine,  
University of Genova,  
Viale Benedetto XV, 6, Genova 16132, Italy  
e-mail: [marianna.meroni@unige.it](mailto:marianna.meroni@unige.it);  
[elenabernero@gmail.com](mailto:elenabernero@gmail.com); [mcutolo@unige.it](mailto:mcutolo@unige.it)

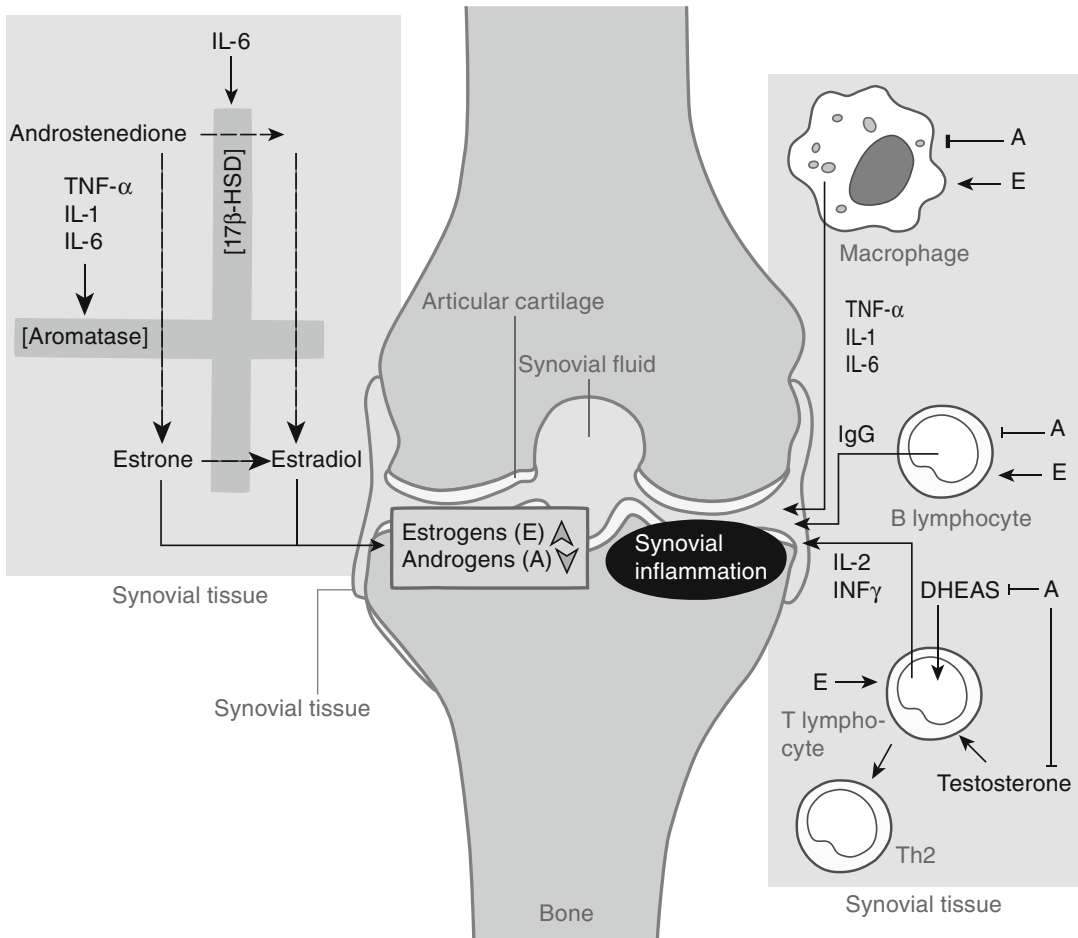

**Fig. 1** Sex hormone synthesis pathways and their influence on cytokine expression in synovial cells. *Left side:* Androgens (such as testosterone) and estrogens (such as estrone and estradiol) originate from common precursors (see chapter “Overview” under part “Reproductive system”). Proinflammatory cytokines promote peripheral (incl. synovial) conversion of estrogens to androgens by acting on the respective enzymes (*light gray boxes*). *Right side:*

Effects of estrogens and androgens on the immune cells and their cytokine production. Estrogens (*E*) may exert stimulatory effects on some activities of macrophages and T-helper 2 ( $T_H2$ ) cells in producing inflammatory cytokines and induce B lymphocytes to secrete IgGs (immunoglobulins G). Androgens (*A*) have an inhibitory effect on the same cells. *TNF $\alpha$*  tumor necrosis factor  $\alpha$ , *IL* Interleukin, *INF $\gamma$*  Interferon  $\gamma$ , *17 $\beta$ -HSD* 17 $\beta$ -Hydroxysteroid dehydrogenase

## The Hypothalamic-Pituitary-Adrenal Axis

The HPA axis (see also chapters “Overview” under part “Brain” and “Major depressive disorder”) influences a number of immunological processes [5, 6].

It involves hypothalamic secretion of corticotropin-releasing hormone (CRH), subsequent synthesis and release of adrenocorticotropic hormone (ACTH) from the pituitary gland,

and resultant production of corticosteroids (glucocorticoid hormones such as cortisol and mineralocorticoids such as aldosterone) in the adrenal cortex. Some intermediates are partially released into the bloodstream and converted to active glucocorticoid hormones [7, 8], androgens, and estrogens in the peripheral tissues (Fig. 1). The conversion of androgens is called intracrinology.

Glucocorticoids possess anti-inflammatory effects on almost all immune cells and can shift the T-cell-mediated immune response from a

cytotoxic T-helper type ( $T_{h1}$ ) to a humoral T-helper type 2 ( $T_{h2}$ ) immune reaction (see chapter “[Overview](#)” under part “[Joints](#)”). They also inhibit the production of proinflammatory cytokines implicated in RA (see above).

Whereas an acute stimulus of the HPA axis triggers a physiological response to cope with stress, chronic stress, e.g., chronic inflammatory diseases or altered psychological status (see chapter “[Major depressive disorder](#)”), impairs and reduces HPA axis activation and compensatory physiological actions [9]. The lack of HPA axis hormones (mainly cortisol and adrenaline), or the reduced adrenal response to acute inflammation, is frequent in RA and other chronic inflammatory conditions and contributes to disease progression. The inhibition (or exhaustion) of the HPA axis finally results in chronically elevated levels of proinflammatory cytokine levels [10]. Therefore, depression and stressful life events are now recognized as main risk factors in chronic inflammatory/autoimmune diseases, notably in RA and systemic lupus erythematosus [11].

### The Hypothalamic-Pituitary-Gonadal Axis

The hypothalamic-pituitary-gonadal (HPG) axis includes hypothalamic production of gonadotropin-releasing hormone, subsequent secretion of follicle-stimulating hormone (FSH) and luteinizing hormone (LH) from the anterior lobe of the pituitary gland, and resultant synthesis of sex hormones (estrogens and androgens) in female or male gonads (see chapter “[Overview](#)” under part “[Reproductive system](#)”). As sex hormones are steroids, they arise from cholesterol and are structurally related to glucocorticoids, thus influencing inflammatory cells [11]. Most importantly, androgens generally prevent the release of proinflammatory cytokines (such as  $TNF\alpha$ , IL-1, and IL-6) from immune cells (within the synovial tissue), whereas estrogens trigger their release (Fig. 1).

Sex hormones can also be created by peripheral steroidal conversion (intracrine metabolism) from precursors. Interestingly, aromatases, which are increased in inflammatory tissues (like RA

synovial tissue), convert peripheral androgens into proinflammatory estrogen metabolites. Fluctuation of symptoms in female RA patients during the menstrual cycle supports an important role of steroid hormones in clinical RA manifestations [12]. More specifically, estrogens trigger the release of proinflammatory cytokines (such as  $TNF\alpha$ , IL-1, and IL-6) from macrophages and T lymphocytes via estrogen receptors A and B (Fig. 1, and see chapters “[Overview](#)” under part “[Reproductive system](#)” and “[Breast cancer](#)”). Effectively, this creates a vicious circle that aggravates RA [13, 14].

### The Vitamin D Endocrine System

The secosteroid vitamin  $D_3$  is generated from the backbone of cholesterol or ingested with the diet. Its inactive form cholecalciferol is created in the skin and further converted into the active forms calcidiol and calcitriol (in the liver and kidney, respectively, see chapter “[Overview](#)” under part “[Teeth and bones](#)”). Too low levels of serum calcidiol are a risk factor for developing autoimmune diseases, such as RA, type 1 diabetes mellitus (see chapter “[Diabetes mellitus](#)”), and others [15, 16].

Vitamin  $D_3$  acts as an immune-modulatory molecule by binding to vitamin D receptors in immune cells. Indeed, several of these cells (e.g., macrophages) can even synthesize calcitriol themselves.

The latter can inhibit the differentiation of B lymphocytes into plasma cells and class-switched memory B cells and can downregulate  $T_{h1}$ -dependent immune responses (see chapters “[Overview](#)” under part “[Joints](#)” and “[Overview](#)” under part “[Gastrointestinal tract](#)”) [17]. In conclusion, vitamin  $D_3$ , cortisol, and sex hormones regulate both innate and adaptive immunity and thus influence RA development [18].

### Circadian Rhythms and the Immune System

Several clinical symptoms in immune-mediated rheumatic diseases (such as RA) are aggravated in the early morning (particularly joint stiffness), since proinflammatory cytokines (such as IL-1, IL-6, and

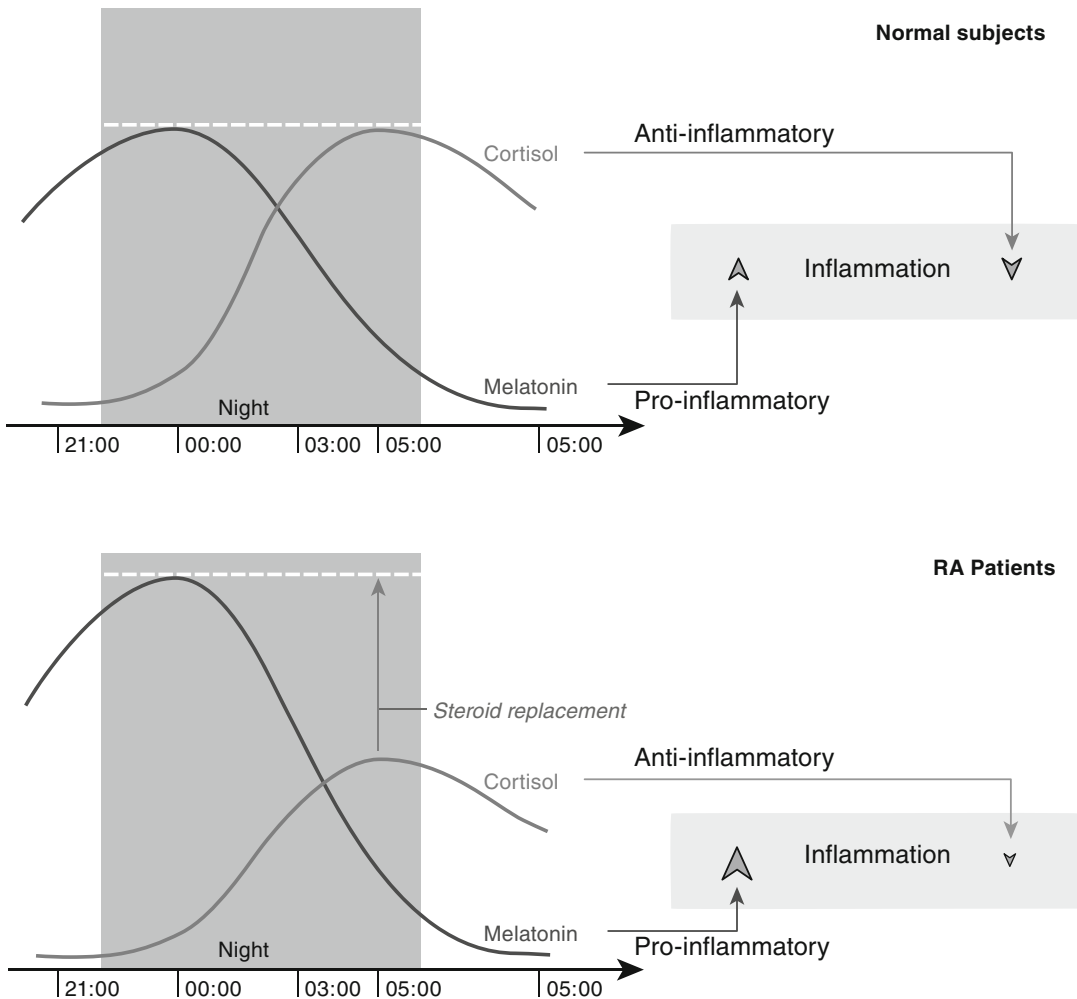

**Fig. 2** Relatively impaired cortisol secretion in rheumatoid arthritis (RA) patients compared to healthy subjects. The cortisol nadir at midnight and the parallel increase of the immune-stimulatory hormone melatonin drive the increase of nightly proinflammatory mediators (not shown). This triggers a delayed expression/release of cortisol, which suppresses the surge in inflammatory tumor necrosis factor

$\alpha$  (*TNF $\alpha$* ), interleukin (IL-)1, and IL-6 mediators at around 5 a.m. In healthy subjects the cortisol secretion is proportional to melatonin levels, whereas in RA patient it is impaired in relation to melatonin, thus favoring immune-inflammatory stimulation. This is the reason why steroid replacement is mandatory as etiological treatment in RA patients and in other inflammatory diseases

TNF $\alpha$ ) display a circadian rhythm, with maximum levels in the early morning [19, 20]. Cortisol also displays a circadian rhythm, increasing until 4–5 am (in response to increased inflammatory cytokines), and thus dampens the cytokine peak.

However, in RA, reduced cortisol production downstream of an impaired HPA axis (relative adrenal insufficiency) is overwhelmed by proinflammatory cytokine action [21]. Such condition generally requires hormonal replacement therapy, i.e., exogenous glucocorticoids (see below, Fig. 2).

### Tailoring Rheumatoid Arthritis Management: Nighttime Modified-Release Glucocorticoid Treatment

The most important treatment option for RA is glucocorticoids to replenish the endogenous pool. This can correct the inflammatory episodes/flares, but of course does not remove the underlying disturbance in the NEI and the already-established damage of the joints in RA. Glucocorticoids are usually given after the patient

awakes in the morning at a time when joint stiffness is already at a maximum. However, this is not optimal. In fact, glucocorticoid administration at 2–3 am is recommended, showing a more marked and significant effect on morning stiffness and serum IL-6 decrease [22].

Consequently, traditional drugs such as prednisone (a synthetic corticosteroid with anti-inflammatory effects and a short half-life) are now administered considering circadian rhythms, to optimize clinical efficacy (Fig. 2) [23]. This tailored administration has the advantage of minimizing steroid treatment-related side effects, like systemic hypertension, hyperglycemia, tachycardia, insomnia, osteopenia/osteoporosis, and, especially, HPA inhibition due to negative feedback [24].

Finally, circannual supplementation therapy with vitamin D (mainly at winter and spring time), in addition to release-modified glucocorticoids, seems to represent an effective NEI treatment strategy in RA management [25, 26].

The role of steroid hormone deficiency in the transition from chronic inflammation to cancer is currently under investigation [27, 28] in particular since RA patients seem at higher risk of developing cancer (see chapter “[Overview](#)” under par “[Cancer](#)”).

---

## Perspectives

The action of different steroid hormones, influenced by the products of activated immune cells, triggers the immune-inflammatory response, targets the organs-specific microenvironments, and influences the rhythms (circadian and circannual) of several other hormones. New therapeutic strategies are based on circadian/circannual rhythms and on the recent knowledge of the complex NEI system that is under such rhythm control.

---

## References

1. Hench PS (1938) The ameliorating effect of pregnancy on chronic atrophic (infectious, rheumatoid) arthritis, fibrositis, and intermittent hydrarthrosis. *Proc Staff Meet Mayo Clin* 13:161–167

2. Hench PS, Slocumb CH, Holley HF, Kendall EC (1950) Effect of cortisone and pituitary adrenocorticotropic hormone (ACTH) on rheumatic diseases. *J Am Med Assoc* 144:1327–1335
3. Straub RH (2007) The complex role of estrogens in inflammation. *Endocr Rev* 28:521–574
4. Webster JI, Tonelli L, Sternberg EM (2002) Neuroendocrine regulation of immunity. *Ann Rev Immunol* 20:125–163
5. Engelmann M, Landgraf R, Wotjak C (2004) The hypothalamic-neurohypophysial system regulates the hypothalamic-pituitary-adrenal axis under stress: an old concept revisited. *Front Neuroendocrinol* 25:132–149
6. Cutolo M, Straub RH, Chrousos GP (2007) Stress and autoimmunity. *Neuroimmunomodulation* 2006, 1st edn. Karger, Switzerland
7. Straub RH, Cutolo M, Buttgereit F, Pongratz G (2010) Energy regulation and neuroendocrine-immune control in chronic inflammatory diseases. *J Intern Med* 267:543–560
8. Labrie F (1991) Intracrinology. *Mol Cell Endocrinol* 78:C113–C118
9. Kanik KS, Chrousos GP, Schumacher HR, Crane ML, Yarboro CH, Wilder RL (2000) Adrenocorticotropin, glucocorticoid, and androgen secretion in patients with new onset synovitis/rheumatoid arthritis: relations with indices of inflammation. *J Clin Endocrinol Metab* 85:1461–1466
10. Straub RH, Paimela L, Peltomaa R, Schölmerich J, Leirisalo-Repo M (2002) Inadequately low serum levels of steroid hormones in relation to IL-6 and TNF in untreated patients with early rheumatoid arthritis and reactive arthritis. *Arthritis Rheum* 46:654–662
11. Straub R, Buttgereit F, Cutolo M (2011) Alterations of the hypothalamic-pituitary-adrenal axis in systemic immune diseases – a role for misguided energy regulation. *Clin Exp Rheumatol* 29:S15–S23
12. Meethal SV, Liu T, Chan HW, Ginsburg E, Wilson AC, Gray DN, Bowen RL, Vonderhaar BK, Atwood CS (2009) Identification of a regulatory loop for the synthesis of neurosteroids: a steroidogenic acute regulatory protein-dependent mechanism involving hypothalamic-pituitary-gonadal axis receptors. *J Neurochem* 110:1014–1027
13. Walker SE, Jacobson JD (2000) Roles of prolactin and gonadotropin-releasing hormone in rheumatic diseases. *Rheum Dis Clin North Am* 26:713–736
14. Cutolo M, Pizzorni C, Sulli A (2011) Vitamin D endocrine system involvement in autoimmune rheumatic diseases. *Autoimmun Rev* 11:84–87
15. Adams JS, Hewison M (2008) Unexpected actions of vitamin D: new perspectives on the regulation of innate and adaptive immunity. *Nat Clin Pract Endocrinol Metab* 4:80–90
16. Cutolo M (2013) Further emergent evidence for the vitamin D endocrine system involvement in autoimmune rheumatic disease risk and prognosis. *Ann Rheum Dis* 72:473–475
17. Chen S, Sims GP, Chen XX, Gu YY, Chen S, Lipsky PE (2007) Modulatory effects of 1,25 dihydroxyvitamin

- D3 on human B cell differentiation. *J Immunol* 179:1634–1647
18. Cutolo M, Plebani M, Shoenfeld Y, Adorini L, Tincani A (2011) Vitamin D endocrine system and the immune response in rheumatic diseases. *Vitam Horm* 86:327–351
  19. Straub RH, Cutolo M (2007) Circadian rhythms in rheumatoid arthritis: implications for pathophysiology and therapeutic management. *Arthritis Rheum* 56:399–408
  20. Cutolo M, Straub RH, Buttgerit F (2008) Circadian rhythms of nocturnal hormones in rheumatoid arthritis: translation from bench to bedside. *Ann Rheum Dis* 67:905–908
  21. Crofford LJ, Kalogeras KT, Mastorakos G, Magiakou MA, Wells J, Kanik KS, Gold PW, Chrousos GP, Wilder RL (1997) Circadian relationships between interleukin (IL)-6 and hypothalamic-pituitary-adrenal axis hormones: failure of IL-6 to cause sustained hypercortisolism in patients with early untreated rheumatoid arthritis. *J Clin Endocrinol Metab* 82:1279–1283
  22. Buttgerit F, Doering G, Schaeffler A, Witte S, Sierakowski S, Gromnica-Ihle E, Jeka S, Krueger K, Szechinski J, Alten R (2008) Efficacy of modified-release versus standard prednisone to reduce duration of morning stiffness of the joints in rheumatoid arthritis (CAPRA-1): a double-blind, randomised controlled trial. *Lancet* 371:205–214
  23. Cutolo M (2012) Chronobiology and the treatment of rheumatoid arthritis. *Curr Opin Rheumatol* 24: 312–318
  24. Cutolo M (2011) Rheumatoid arthritis: circadian and circannual rhythms in RA. *Nat Rev Rheumatol* 7: 500–502
  25. Villaggio B, Soldano S, Cutolo M (2012) 1,25-dihydroxyvitamin D3 downregulates aromatase expression and inflammatory cytokines in human macrophages. *Clin Exp Rheumatol* 30:934–938
  26. Cutolo M (2010) Hormone therapy in rheumatic diseases. *Curr Opin Rheumatol* 22:257–263
  27. Cutolo M (2012) The challenges of using vitamin D in cancer prevention and prognosis. *Isr Med Assoc J* 14:637–639
  28. Cutolo M, Sulli A, Straub RH (2014) Estrogen's effects in chronic autoimmune/inflammatory diseases and progression to cancer. *Expert Rev Clin Immunol* 10(1):31–39. doi:10.1586/1744666X.2014.863149.

---

**Part V**

**Gastrointestinal Tract**



---

## Overview

Satish Keshav and Philip Allan

---

### Anatomy and Physiology of the Gastrointestinal Tract

The gastrointestinal tract (GIT) is divided into distinct subunits, with morphological and functional differences: mouth including teeth, esophagus, stomach, pancreas and biliary tract, liver, duodenum, jejunum, ileum, colon, and anus. The different functions are reflected in macroscopic and microscopic anatomy. Macroscopically the stomach, for instance, has longitudinal, oblique, and circular muscle layers to mix and churn food and so aid digestion. Microscopically, the cells lining the stomach include specialized H cells that produce hydrochloric acid (see below).

In contrast, the ileum is an approximately 3 m long tube-like structure, with circular and smooth muscle optimized for peristalsis, and microscopically, the predominant cell type is the enterocyte, specialized for absorption of nutrients. The surface area of the ileum is increased by internal folds covered with projecting villi. These in turn are microscopically covered with microvilli, which project from the luminal surface of the epithelial cells.

The colon is specialized for extracting water, solidifying waste into feces before excretion. Bacteria in the colon aid metabolism by producing short chain fatty acids (SCFAs) such as butyrate, which is a source of energy for colonic epithelial cells. In this chapter we review important functions of the gastrointestinal tract, particularly the stomach, ileum, and colon, emphasizing nutritional and metabolic implications.

---

### Gastrointestinal Tract-Specific Metabolic/Molecular Pathways and Processes

#### The Stomach

The stomach expands to accommodate food after a meal, initiates the release of hormones that coordinate subsequent events, and secretes hydrochloric acid (HCl), which converts pepsinogen into functional pepsin. Pepsin digests dietary proteins and peptides into smaller peptides that are further digested and absorbed as oligo- and dipeptides in the duodenum, jejunum, and ileum.

HCl creates an environment that is inhospitable to most microorganisms. Epithelial cells are protected from the effects of HCl by a number of mechanisms including gastric mucus. Additionally, gastric acid favors the reduction of iron from ferrous to ferric ( $\text{Fe}^{2+}$  to  $\text{Fe}^{3+}$ ), which promotes its absorption in the proximal duodenum. In addition, intrinsic factor (IF) secreted by

---

S. Keshav (✉) • P. Allan  
Experimental Medicine Division,  
John Radcliffe Hospital,  
Level 5, Room 5800, Headley Way, Headington,  
Oxford OX3 9DU, UK  
e-mail: [satish.keshav@ndm.ox.ac.uk](mailto:satish.keshav@ndm.ox.ac.uk);  
[p.allan@doctors.org.uk](mailto:p.allan@doctors.org.uk)

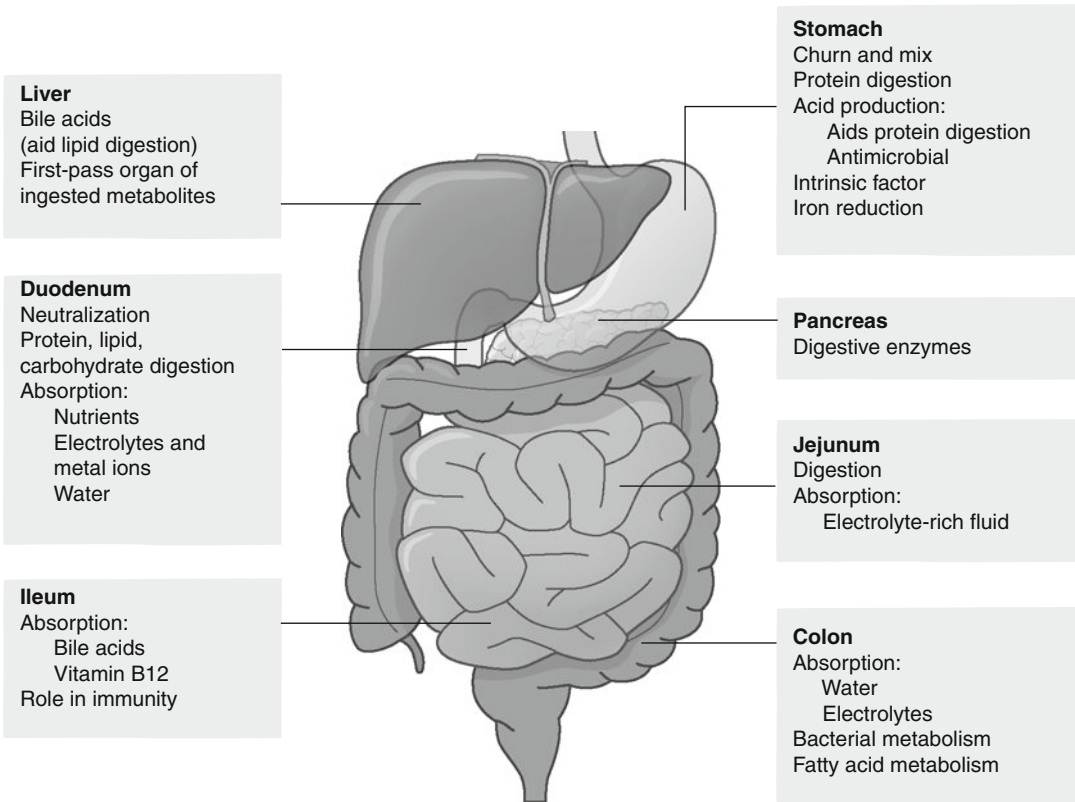

**Fig. 1** Overview of the gut with summary of main functions demonstrating absorption of water and electrolytes, carbohydrate, lipid, proteins, vitamins, and minerals. Gut

physiology is determined by the specialized cells lining the epithelium with absorption of different molecules in different parts of the gut

the gastric mucosa binds to dietary cobalamin, protecting it from digestion and enabling absorption in the terminal ileum (Fig. 1).

### The Small Intestine: Duodenum, Jejunum, and Ileum

The small intestine is differentiated along its length, with distinct functions occurring in duodenum, jejunum, and ileum. Acidic chyme from stomach is released gradually into the duodenum, where it is mixed with alkaline bile and pancreatic secretions rich in  $\text{HCO}_3^-$ . The duodenal mucosa is specialized for absorption.

The pancreas produces the bulk of digestive enzymes for carbohydrates, lipids, and proteins, and bile acids contribute to the formation of mixed micelles of lipid, aiding their digestion.

Intestinal epithelial cells contribute to digestion by secreting enzymes such as lactase (see chapter “[Lactose intolerance](#)”) that are bound to their surface and express in their cell membranes protein transporters that enable nutrients to pass from the lumen of the intestine into the epithelial cell and then out of the cell and into the lymphatic and vascular circulation (lipophilic and hydrophilic substances, respectively). In addition, epithelial cells absorb electrolytes and metallic trace elements such as  $\text{Na}^+$ ,  $\text{K}^+$ ,  $\text{Ca}^{2+}$ ,  $\text{Mg}^{2+}$ ,  $\text{Zn}^{2+}$ ,  $\text{Cu}^{2+}$ , and water. Paracellular movement of water and electrolytes also occurs, and the direction, either into or out of the lumen, depends on osmotic and ionic gradients. Tight junctions between epithelial cells are more effective distally, and paracellular transport in the healthy intestine plays only a minor role.

Digestion and absorption continue in the jejunum, where much of the electrolyte-rich fluid that is secreted by the stomach, pancreas, and duodenum is reabsorbed. Without this reabsorption, total body water,  $\text{Na}^+$ ,  $\text{K}^+$ , and  $\text{Mg}^{2+}$  are rapidly depleted, presenting a clinical problem for patients who undergo intestinal resection leaving them with a jejunostomy or proximal ileostomy.

The terminal ileum is particularly important for the absorption of bile acids and Vitamin  $\text{B}_{12}$ . As a consequence, disease of the ileum can cause vitamin  $\text{B}_{12}$  deficiency and diarrhea caused by loss of the enterohepatic circulation of bile salts (see chapter “[Overview](#)” under part “[Liver](#)”), with consequent excess of these in the colon, where they cause secretion of water and electrolytes [1]. The ileum also acts as a barrier between the large and small intestine, with effects on bacterial populations, and intestinal motility. Finally, the ileum plays a prominent role for the immune system (see below) [2].

Absorption of carbohydrates requires digestion of complex carbohydrates into monosaccharides, as polysaccharides and disaccharides cannot be absorbed. Lactose, a disaccharide of galactose and glucose, is the main sugar in bovine and human milk and is digested by lactase, which is produced by intestinal epithelial cells. Lack of lactase causes lactose intolerance, in which colonic bacteria digest lactose to produce fermentation by-products, which, with the lactose, increases the osmotic gradient and results in diarrhea (see chapter “[Lactose intolerance](#)”). Furthermore, excess lactose may alter colonic bacteria. Avoiding dietary dairy can lead to  $\text{Ca}^+$  deficiency and potentially osteomalacia (Fig. 2).

### **The Large Intestine: Cecum, Colon, and Rectum**

The main function of the specialized colonic epithelium is to reabsorb  $\text{H}_2\text{O}$  from the 3–6 l/day of fluid that enters the cecum, so that approximately 200 ml is excreted as fecal waste. Reabsorbed water is accompanied by electrolytes, particularly  $\text{Na}^+$ ,  $\text{K}^+$ , and  $\text{Mg}^{2+}$ . Colonic bacteria metabolize fats and contribute to the provision of

essential fatty acids. Tight junctions between colonic epithelial cells prevent salt and water loss from the interstitial tissue space and limit the translocation of bacteria and toxins from the colonic lumen into the circulation.

The practical importance of reabsorption is illustrated by patients who have undergone extensive resection of the small intestine. When they have a proximal jejunostomy or ileostomy, loss of salt and water means that they require regular intravenous supplementation, even when absorption of dietary carbohydrate, fat, and protein is sufficient. In such cases, anastomosis of the small intestine to the colon typically reverses dependence on intravenous fluids.

Colonic bacteria contribute metabolically to the host. Food residue in the colon is fermented, yielding gases such as methane ( $\text{CH}_4$ ),  $\text{H}_2$ , and  $\text{CO}_2$  and short chain fatty acids (SCFAs), such as acetate, butyrate, and propionate. However, fermentation can also produce toxic metabolites (see below). Butyrate is a major energy source for colonic epithelial cells and its absence can result in inflammation (see also chapter “[Colorectal cancer](#)”).

Moreover, the mix of colonic bacterial species, termed the microbiome, varies between individuals. This variation may be associated with diseases including obesity and autoimmunity [3].

---

### **Inside-In: Metabolites of the Gastrointestinal Tract Affecting Itself**

Regulation of digestive processes involves structures in the hypothalamus (see chapters “[Overview](#)” under part “[Brain](#)”, “[Diabetes mellitus](#)”, and “[Overview](#)” under part “[Brain](#)”), yet it also occurs to a major part within the gastrointestinal tract, starting with the amount of food intake sensed by chewing and stomach filling. Most importantly, the stomach releases hormones, such as gastrin, cholecystokinin (CCK), and secretin, which in turn promote the release of  $\text{HCl}$ , stimulate contraction of the gallbladder, and promote secretion from the pancreatobiliary system, while enhancing intestinal propulsion.

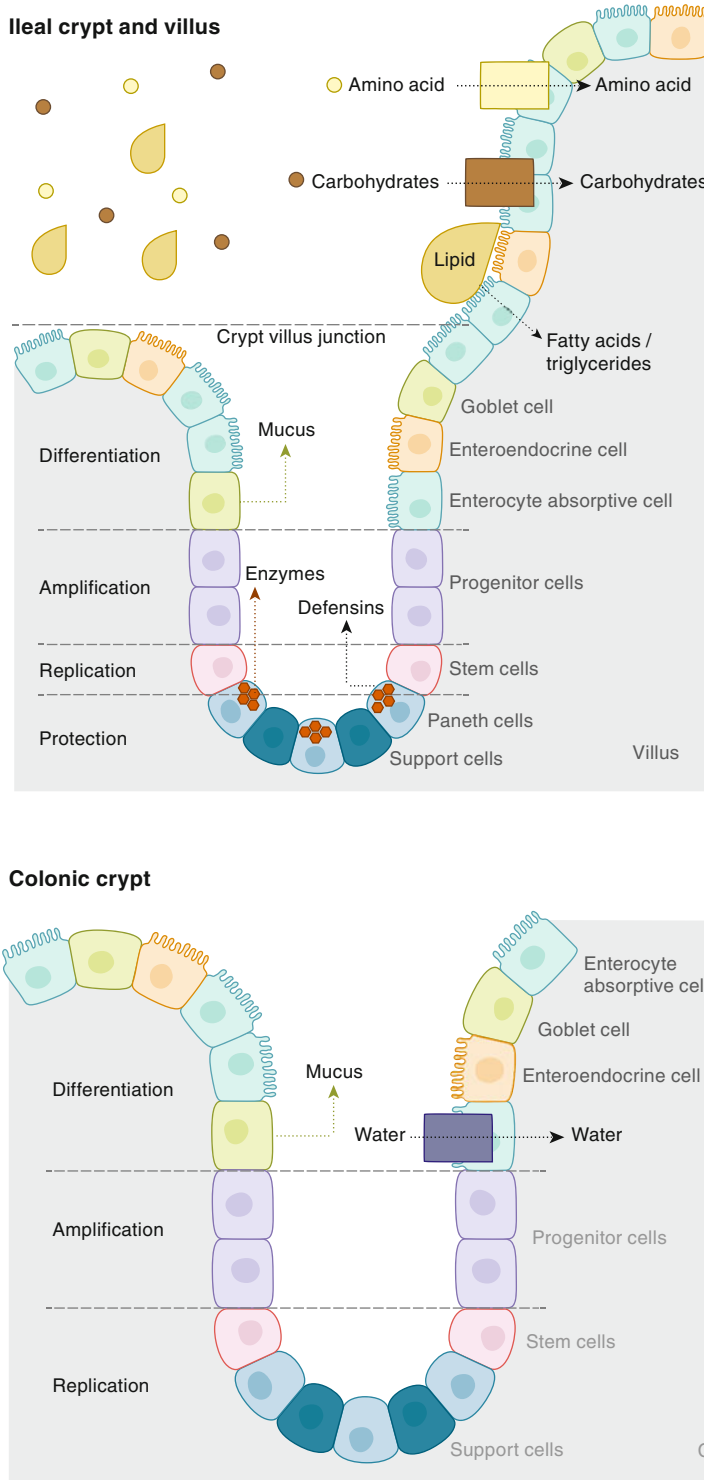

**Fig. 2** Diagram of the microscopic appearance of a stylized crypt-villus unit and colonic crypt, showing specialized cells, enzymes, absorption, secretion, and immune functions

## Outside-In: Metabolites of Other Tissues and External Factors Affecting the Gastrointestinal Tract

### Stomach

*Helicobacter pylori* (*H. pylori*) is an infectious bacterial strain that has adapted to gastric acid by secreting a urease that generates  $\text{NH}_4^+$  from urea, thus raising the local pH. As a consequence, *H. pylori* infection is widespread and is associated with a number of diseases including gastritis, peptic ulcer (see chapter “[Peptic ulcer disease](#)”), and gastric cancer.

Consequently, *H. pylori* can cause metabolic and nutritional problems, with hypochlorhydria, reduced IF production, and gastritis leading to bleeding.

### Small Intestine

There are several examples how circulating hormones and neural signals can regulate intestinal absorption [4]. However, a detailed discussion is not within the scope of this chapter.

Iron transporters particularly are concentrated proximally, where the majority of iron is absorbed. As an example, iron absorption is inhibited by the circulating hormone hepcidin, levels of which are increased by infection and inflammation contributing to the anemia seen in many chronic diseases.

The small intestine is also highly relevant to the interaction with endogenous material and antigens. Thus, intestinal lymphoid tissue is concentrated in the ileum, with many prominent Peyer’s patches, and specialized cells that form part of the innate immune system (see chapter “[Overview](#)” under part “Immune system”), such as Paneth cells, are most abundant in the ileum [2]. Paneth cells and goblet cells, among others, produce many antibacterial proteins such as  $\alpha$  and  $\beta$  defensins, regenerating (REG) proteins, and cathelicidins. Innate and adaptive immune mechanisms, as well the effects of constant propulsion along the intestinal tract, and chemical and mechanical barrier functions of glycosaminoglycan-rich mucus maintain near sterility of the small intestine, with approximately  $10^5$ – $10^7$  bacteria/ml of luminal

content, compared to  $10^{11}$ – $10^{12}$ /ml in the colon. Commensal bacteria in the intestine probably have a symbiotic relationship with the host, preventing colonization by pathogens by competing for the ecological niche and contributing partly to the production of nutrients such as vitamin K.

---

## Inside-Out: Metabolites of the Gastrointestinal Tract Affecting Other Tissues

Obviously, the main function of the gastrointestinal tract is to supply the whole body with nutrients, electrolytes, and trace elements required for regular metabolism and homeostasis.

### Small Intestine

Additionally, the gastrointestinal tract, more specifically the small intestine, can act as an endocrine organ secreting incretins, which act on pancreatic  $\beta$ -cells causing an increase in insulin secretion even before blood glucose is elevated or delay gastric emptying (see chapters “[Overview](#)” under part “Pancreas” and “[Diabetes mellitus](#)”).

### Colon

Fermentation by colonic bacteria can produce toxic metabolites that can be absorbed into the circulation to exert systemic effects (see chapter “[Cirrhosis](#)”). There is therefore now a concerted research effort aimed at understanding how the microbiome interacts with the intestine and the whole body in health and disease.

---

## Typical Pathology of the Gastrointestinal Tract

### Stomach and Small Intestine

Vomiting causes loss of acid. This loss results in concomitant  $\text{K}^+$  loss in the urine to favor retention of hydrogen ( $\text{H}^+$ ) ions (see chapter “[Overview](#)”

under part “Kidney”). The loss of  $K^+$  can be exacerbated by diarrhea, which also causes loss of  $Mg^{2+}$  and  $Ca^{2+}$ . The absorption of vitamins and minerals can also be affected by intestinal transit time and absorptive capacity. Acute illnesses, such as gastroenteritis (see chapter “[Gastroenteritis](#)”), do not typically cause nutritional deficiencies. However, in chronic disease, water-soluble vitamins, e.g., thiamine (B1), riboflavin (B2), pyridoxine (B6), niacin, folate, B12, and ascorbic acid (C), initially, and later fat-soluble vitamins (vitamins A, D, E, and K) may become deficient. Essential minerals, such as  $Zn^{2+}$ ,  $Cu^{2+}$ , selenium, and phosphate, are also typically depleted in chronic malabsorptive states [5].

## Colon

The capacity of the colon to reabsorb water and electrolytes is reduced by inflammation, including infection, ulcerative colitis, and microscopic colitis. Bile acid diarrhea results from colonic secretion stimulated by bile acids that are not reabsorbed in the ileum, when they enter the colon. Laxatives and microbial toxins can also stimulate secretion and cause diarrhea. An example is the heat stable enterotoxin of *E. coli*, STa, which binds to a guanylate cyclase-linked receptor expressed on the surface of colonic epithelial cells, causing secretion of  $Cl^-$  and water secondary to increased intracellular cGMP.

Colorectal cancer (CRC, see chapter “[Colorectal cancer](#)”) is a major cause of morbidity and mortality. The interaction of diet and the microbiome may provide a mechanistic link for these observations. Chronic inflammation of the colon, including longstanding ulcerative colitis increases the risk of CRC [5].

## Final Remarks

The intestine is critically important for nutrition and metabolism and has to meet major challenges posed by the ingestion of food containing potential toxins and pathogens. Specialized structures at the macroscopic and microscopic level contribute to the function of the gastrointestinal tract and are altered in disease. A symbiotic relationship with commensal intestinal microorganisms is only now being understood in more detail, and alterations in this relationship may be a major determinant of health and disease. This introductory chapter is followed by more detailed chapters on important and common intestinal diseases, i.e., *H. pylori* infection (see chapter “[Peptic ulcer disease](#)”), gastroenteritis (see chapter “[Gastroenteritis](#)”), lactose intolerance (see chapter “[Lactose intolerance](#)”), and colorectal cancer (see chapter “[Colorectal cancer](#)”). For further information, the reader is referred to more extensive textbooks of gastroenterology [5, 6].

## References

1. Chiang JY (2013) Bile acid metabolism and signaling. *Compr Physiol* 3:1191–1212
2. Keshav S (2006) Paneth cells: leukocyte-like mediators of innate immunity in the intestine. *J Leukoc Biol* 80:500–508
3. Karlsson F, Tremaroli V, Nielsen J, Bäckhed F (2013) Assessing the human gut microbiota in metabolic diseases. *Diabetes* 62:3341–3349
4. Mourad FH, Saadé NE (2011) Neural regulation of intestinal nutrient absorption. *Prog Neurobiol* 95:149–162
5. Keshav S, Culver E (2011) *Gastroenterology: clinical cases uncovered*, 1st edn. Wiley-Blackwell, New York
6. Keshav S, Bailey E (2012) *The gastrointestinal system at a glance*, 2nd edn. Wiley-Blackwell, New York

---

# Peptic Ulcer Disease

Peter C. Konturek and Stanislaw J. Konturek

---

## Introduction to Peptic Ulcer Disease

Peptic ulcer disease (PUD) is defined as a defect in the lining of the gastrointestinal mucosa, with appreciable depth or involvement of the submucosa [1]. The development of peptic ulceration is a result of an imbalance between factors potentially damaging the gastric mucosa (aggressive) and protective (defensive) factors. The former include endogenous factors (e.g., gastric acid and pepsin) and exogenous factors including chronic *Helicobacter pylori* (Hp) infection, use of nonsteroidal anti-inflammatory drugs (NSAIDs), consumption of alcohol, smoking, and exposure to stress [2]. The latter comprise pre-epithelial defense (secretion of mucus and bicarbonates), epithelial defense (epithelial restitution and replication, extracellular buffers including bicarbonates), and post-epithelial defense (mucosal microcirculation, tissue acid-base balance).

Sometimes the definitive cause of the ulcer cannot be established (“idiopathic ulcer”). The

possible pathogenetic factors associated with this rare peptic ulceration are older age, multimorbidity, recent surgery, underlying sepsis, and medication (other than NSAIDs ulcerogenic drugs).

Peptic ulcer is typically localized in the stomach (gastric ulcer) and duodenum (duodenal ulcer), most commonly in the duodenal bulb (the part of the duodenum closest to the stomach) due to the high exposure to gastric acid. Small areas of the duodenum colonized by Hp, called duodenal gastric metaplasia, may additionally contribute to the pathogenesis of PUD in duodenum [3].

The most common symptoms of PUD are abdominal pain, vomiting, hematemesis (vomiting of blood), and melena (the passage of dark stools stained with altered blood). In contrast, older patients (>80 years) often lack abdominal pain. Pain occurs typically during the night, when gastric acidity is increased (due to circadian changes) and buffering food intake is minimal [4].

Complications of PUD include bleeding, perforation of stomach or duodenum, and gastric outlet obstruction (i.e., an obstructed pylorus) that could be fatal if untreated [5]. More often, gastric outlet obstruction is caused by neoplasia, however.

Duodenoscopy is the current standard for diagnosis of PUD revealing its localization and possible complications (especially bleeding). In addition, endoscopy allows obtaining biopsies from gastric mucosa for detection of Hp infection [6].

---

P.C. Konturek (✉)  
Second Department of Internal Medicine,  
Thuringia Clinic Saalfeld,  
Rainweg 68, Saalfeld/Saale 07318, Germany  
e-mail: [pkonturek@thueringen-kliniken.de](mailto:pkonturek@thueringen-kliniken.de)

S.J. Konturek  
Institute of Physiology,  
Jagiellonian University Cracow,  
Grzegorzeczka Str. 16, Krakow 31-525, Poland  
e-mail: [mpkontur@cyf-kr.edu.pl](mailto:mpkontur@cyf-kr.edu.pl)



## Pathophysiology of Peptic Ulcer Disease and Metabolic Alterations

Among the endogenous aggressive factors, gastric acid and pepsin play a crucial role, as shown by Schwartz' dictum: "no acid, no ulcer" [7]. Both are required for digestion of nutrients but also pose a threat to the gastric mucosa due to acidity and protein degradation capabilities.

Secretion of acid and pepsin in the stomach is stimulated by gastrin and inhibited by prostaglandins, mainly prostaglandin E<sub>2</sub> (PGE<sub>2</sub>). PGE<sub>2</sub> also reinforces the mucosal defense by increased production of bicarbonate and mucus in the stomach (see chapter "Overview" under part "Gastrointestinal tract"). Other defensive factors include mucosal blood flow, nitric oxide (NO), hydrogen sulfide (H<sub>2</sub>S), locally produced mucosal growth factors such as epidermal growth factor (EGF) and vascular endothelial growth factor-A (VEGF-A), and others mediators (Fig. 1) [2, 3].

The mucosal microvasculature is of critical importance as it maintains a relatively high pH in the superficial epithelium and releases prostaglandins, NO, procoagulant factors, and protective growth factors [8]. Chronic Hp infection of gastric mucosa is the most important risk factor for PUD [9]. Hp induces a chronic inflammatory immune response, the intensity of which depends on strain-specific virulence factors, host genetic factors, duration of infection, and the location (antrum-predominant gastritis or gastritis of the whole gastric mucosa, called pangastritis; see chapter "Overview" under part "Gastrointestinal tract") [10].

In antrum-predominant gastritis, the concentration of somatostatin decreases due to the reduction in the number of somatostatin-producing cells in the antrum causing hypergastrinemia. This, in turn, increases gastric acid secretion and causes the appearance of gastric metaplasia, i.e., small surface areas resembling gastric mucosa in the duodenal bulb. Metaplastic epithelium in the duodenal bulb can further become infected by Hp causing an inflammatory response (duodenitis) followed by peptic ulcer formation [11, 12].

In pangastritis, gastric acid output is decreased due to proinflammatory cytokines (interleukin 1 $\beta$ , tumor necrosis factor  $\alpha$ ) and gastric atrophy.

However, the chronic inflammatory response and the increased release of proinflammatory cytokines impair mucus secretion and epithelial defense mechanisms (cell restitution and mucosal reparative mechanisms) resulting in ulceration in the stomach [13].

The second most important cause of PUD is use of NSAIDs (including aspirin and ibuprofen), which may profoundly inhibit the mucosal defense mechanisms and cause peptic ulcer and bleeding, synergistic to Hp. 5–20 % of frequent NSAID users develop PUD. The ulcerogenic effect of many NSAIDs is mainly caused by inhibition of the cyclooxygenases 1 and 2 (COX-1, COX-2) in the gastric mucosa, key enzymes in the synthesis of prostaglandins. This decreases mucus and bicarbonate production, mucosal blood flow, and epithelial cell proliferation and restitution and increases gastric acid secretion. Other pathogenetic factors are also involved in NSAID-induced ulcerogenesis, such as direct topical injury [14]. NSAIDs might also inhibit mucosal generation of growth factors, decrease synthesis of protective polyamines and H<sub>2</sub>S, and increase nitric oxide (NO) release due to upregulation of inducible NO synthase [15].

Other causes of Hp-negative (Hp<sup>-</sup>) ulcers are smoking, alcohol consumption, and the presence of different comorbidities, such as liver cirrhosis (see chapter "Cirrhosis") and chronic renal failure (see chapter "Chronic kidney disease") [16]. Cigarette smoking stimulates basal acid output, increases generation of reactive oxygen species (ROS) in gastrointestinal mucosa, and reduces secretion of EGF and PGE<sub>2</sub> [17]. Alcohol consumption damages the mucosal barrier by inducing a range of effects from subtle mucosal erythema (i.e., redness due to increased blood flow, e.g., as a result of vasodilation) to hemorrhagic (bleeding) gastritis. The damaging effect of ethanol appears as early as 30 min after ingestion of ethanol and reaches a peak at about 60 min. The damaging effect of ethanol is caused by impairment of mucosal microcirculation, declined level of prostaglandins, and increased generation of ROS and NO [18]. Interestingly, coffee consumption shows no association with increased risk for the development of PUD [19].



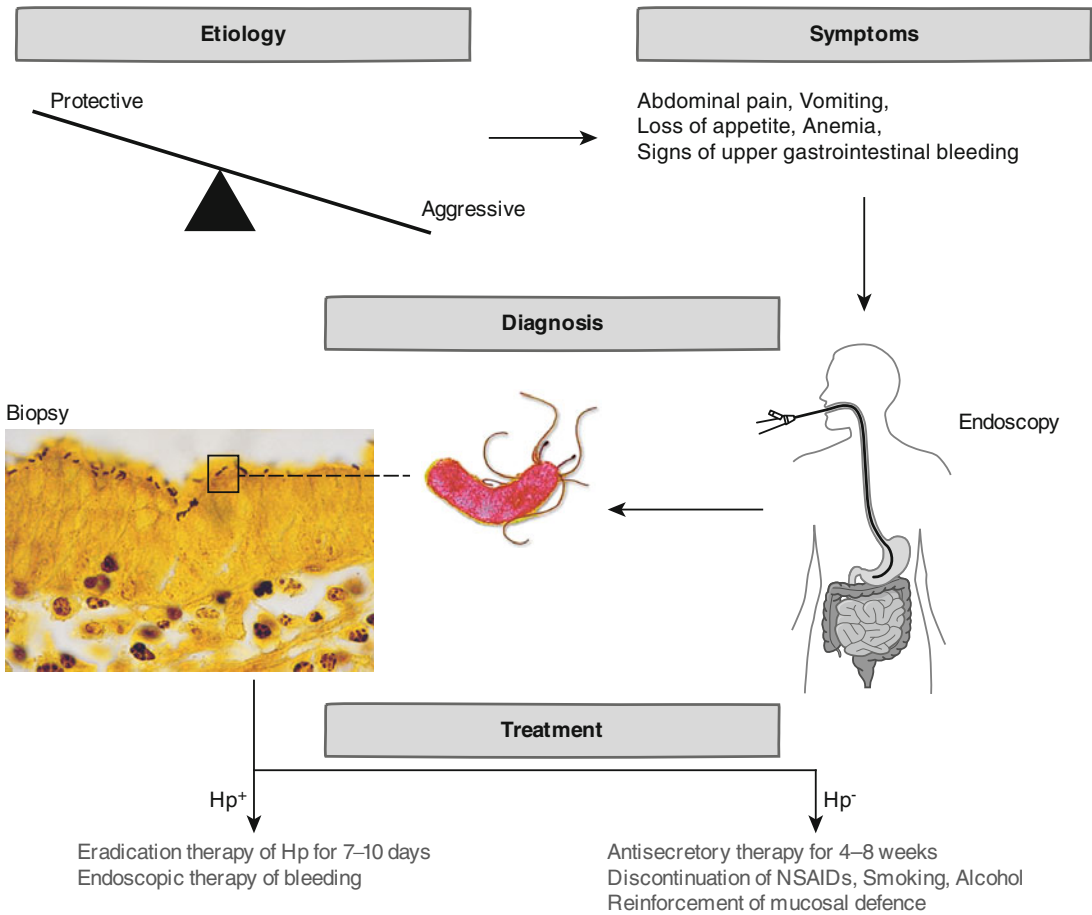

**Fig. 1** Pathogenesis of peptic ulcer disease (PUD). PUD develops due to an imbalance between aggressive and protective factors within the gastric mucosa and commonly causes vomiting, loss of appetite, anemia, and upper gastrointestinal bleeding. It is diagnosed by esophagogastroduodenoscopy (upper endoscopy), which allows localization and treatment (endoscopic hemostasis) of the

ulcer. Additionally, biopsies are taken to determine the presence ( $Hp^+$ ) or absence ( $Hp^-$ ) of *Helicobacter pylori* infection resulting in eradication therapy or treatment with anti-secretory drugs, respectively. Drugs reinforcing mucosal defense can be used instead of anti-secretory drugs. Alcohol and smoking should be avoided

### Treatment of Peptic Ulcer Disease

The treatment strategy of PUD depends on the presence or absence of  $Hp$  infection (Fig. 1).

In  $Hp^+$  ulcers, eradication of  $Hp$  is usually achieved by a combination of acid-inhibiting therapy and two antibiotics (standard triple therapy). Whereas antibiotics specifically kill  $Hp$ , acid inhibitors prevent progression and complications of PUD. Acid inhibitors, especially proton pump inhibitors (PPI), synergize with the antibiotics by effectively increasing gastric pH. However, antibiotic resistance of  $Hp$  is rising,

hampering the eradication rates. Alternative, second-line therapeutic strategies include quadruple therapy (adding treatment with bismuth salts, which shows strong antimicrobial activity), sequential therapy (adding different antibiotics stepwise), or fluoroquinolone-based (antibiotic) regimens [20]. Eradication of  $Hp$  has become the standard prophylaxis treatment to prevent recurrence of PUD [21] and even reduces the incidence of PUD and the risk of peptic ulcer bleeding in NSAID/aspirin users [22].

Treatment of  $Hp^-$  ulcers is governed by reduction of factors that attack the gastroduodenal

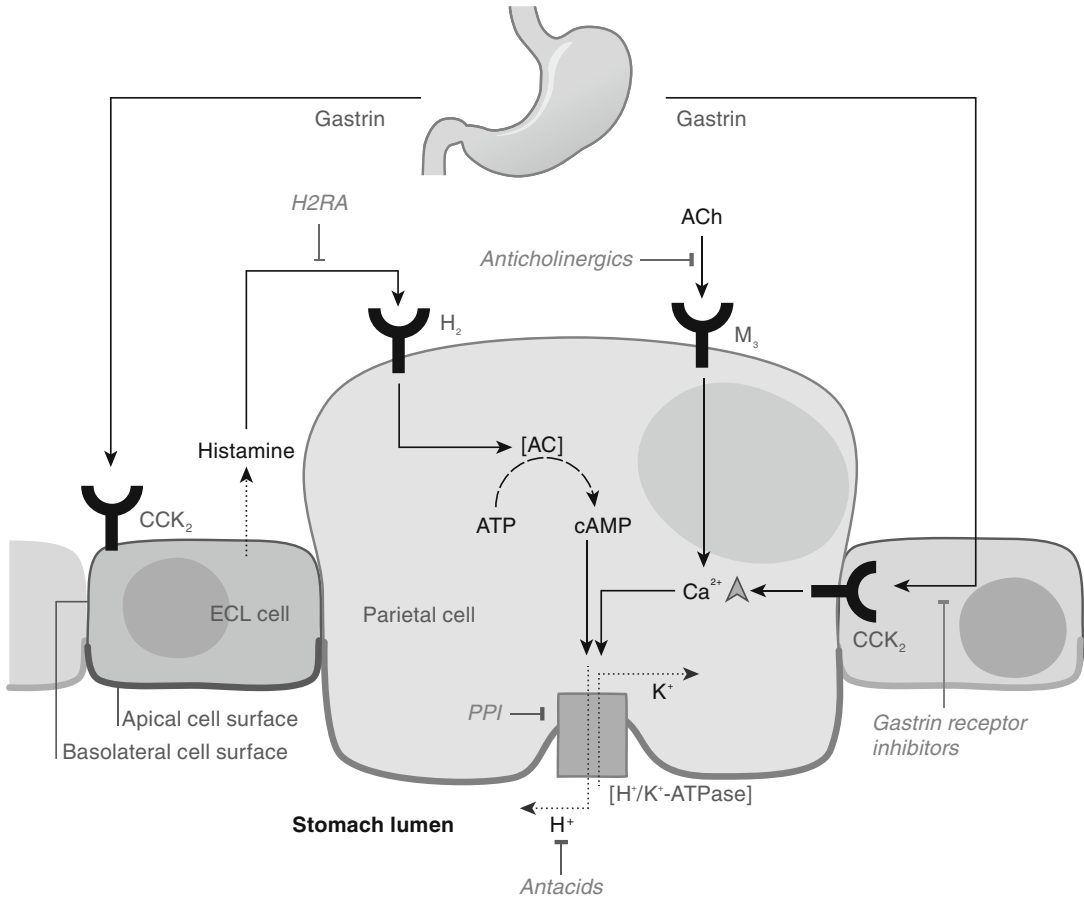

**Fig. 2** Working mechanism of anti-secretory drugs. Anti-secretory drugs prevent the release of gastric acid by acting on the H<sup>+</sup>/K<sup>+</sup>-ATPase. Histamine H<sub>2</sub> receptor (H<sub>2</sub>R) antagonists (H<sub>2</sub>RA) competitively and reversibly block H<sub>2</sub>R, inhibiting signaling via adenylate cyclase (AC) to reduce cAMP levels and thus H<sup>+</sup> secretion. PPIs (proton pump inhibitors) directly inhibit the ATPase.

Anticholinergics block acetylcholine (ACh) effects via the M<sub>3</sub> receptors, decreasing intracellular Ca<sup>2+</sup>. Similarly, blockade of gastrin receptors (CCK<sub>2</sub>) reduces intracellular Ca<sup>2+</sup> but also decreases histamine release from enterochromaffin (ECL) cells. However, these drugs are currently not used in PUD. Antacids directly neutralize acid within the gastrointestinal tract

mucosa (such as gastric acid) or at reinforcement of the mucosal defense mechanisms. Inhibition of aggressive factors includes (1) compounds neutralizing acid, called antacids; (2) inhibitors of acid and pepsin secretion, such as anticholinergics, histamine H<sub>2</sub> receptor antagonists (H<sub>2</sub>RA), and proton pump inhibitors (PPIs); and (3) compounds eliminating potentially cytotoxic elements in the gastroduodenal secretions like bile acids or lecithin (Fig. 2).

H<sub>2</sub>RAs block the stimulatory effect on acid secretion of histamine, released from enterochromaffin cells (ECL). PPIs covalently bind to the H<sup>+</sup>/K<sup>+</sup>-ATPase on parietal cells within the

stomach epithelium (see chapter “[Overview](#)” under part “[Gastrointestinal tract](#)”) to inhibit this transporter and thus acid secretion. PPIs show improved peptic ulcer healing and faster pain relief compared to H<sub>2</sub>RAs [23]. Pharmacological strategies to reinforce the mucosal defense mechanisms increase protective factors (PGE, EGF), gastric mucus and alkaline secretion, and gastric mucosal blood flow, trigger or facilitate reparative mechanisms, and decrease ROS [24].

Bleeding remains an important complication of PUD with a high mortality rate (5–15 %), especially in the elderly due to increased use of low-dose aspirin for prevention of cardiovascular

diseases. Management of bleeding includes multimodal endoscopic techniques to stop the gastrointestinal bleeding (endoscopic hemostasis) followed by pharmacological acid suppression with PPI or H2RA. Moreover, high doses of intravenously administered PPIs are recommended to reduce risk of re-bleeding after endoscopic hemostasis [25]. If repeated endoscopies fail or perforation (of the gastrointestinal wall) is present, surgical therapy is indicated, the exact type of which is controversial, ranging from oversewing to partial gastrectomy [26].

---

## Influence of Treatment on Metabolism and Consequences for Patients

### Therapy of Hp<sup>+</sup> PUD

The commonly used first-line standard triple therapy includes two antibiotics, such as clarithromycin or metronidazole, and amoxicillin along with a PPI, such as omeprazole, lansoprazole, pantoprazole, rabeprazole, or esomeprazole, and is given for 7–14 days. Sequential therapy, which shows significantly higher eradication rates [27], generally consists of PPI and amoxicillin for the first 5 days, followed by PPI along with clarithromycin and metronidazole for 5 days.

Second-line treatment adds bismuth salts or a fluoroquinolone-based antibiotic (e.g., levofloxacin or moxifloxacin) to PPI and the other antibiotics. If second-line therapy fails, further eradication depends on the antibiotic susceptibility [28].

In patients with antrum-predominant gastritis, eradication of Hp restores impaired gastrin-somatostatin link, decreases basal and stimulated acid secretion in the stomach, and restores acid load in the duodenum. However, the atrophy of gastric mucosa does not reverse after successful eradication of Hp [29].

### Therapy of Hp<sup>-</sup> PUD

Most antacids are inorganic salts (magnesium and/or aluminum hydroxide and/or bicarbonate, and calcium carbonate), which neutralize gastric acid

directly. Aluminum additionally increases synthesis of PGE<sub>2</sub> and gastric mucosal microcirculation, yet it may cause constipation. Magnesium can cause diarrhea. Due to their adsorptive capacity, these antacids may hinder intestinal absorption of concurrent medication. Moreover, antacids containing sodium bicarbonate, magnesium hydroxide, and calcium carbonate are contraindicated in patients with renal insufficiency [30].

Anticholinergics (e.g., pirenzepine or telenzepine) speed up the healing of peptic ulcers due to their inhibitory effect on gastric acid secretion. However, side effects include visual disturbances, photophobia, and dryness of the mouth, limiting their use, especially in patients with glaucoma (see chapter “Glaucoma”), enlarged prostate, or stenosis of the pylorus sphincter [31].

H2RAs (e.g., cimetidine, ranitidine, famotidine, nazatidine, roxatidine) competitively and reversibly block the H2R on the basolateral membrane of the parietal cells inhibiting mainly basal and partially meal-stimulated gastric acid secretion. Possible side effects of H2RAs include the development of tolerance and rebound acid hypersecretion (a temporary increase in gastric acid secretion after the abrupt withdrawal of H2RA) [32].

PPIs (e.g., omeprazole, lansoprazole, pantoprazole, and rabeprazole) inhibit acid secretion by the parietal cell [33]. Although gastric acid inhibition is very effective, prolonged suppression favors small intestinal bacterial overgrowth and concomitant malabsorption and facilitates enteric infections (especially with *Clostridium difficile*), as bacteria are no longer effectively eliminated in the stomach [34]. Additionally, osteoporosis (due to parathyroid hyperplasia, see chapter “Osteoporosis”) and hyperplasia of enterochromaffin cells (due to chronic hypergastrinemia) can develop (Fig. 2) [35].

To enhance mucosal defense, initially, misoprostol, a prostaglandin E1 analogue, was used. Unfortunately, its use was limited by abdominal pain and diarrhea due to its stimulatory effect on intestinal motility [36]. Sucralfate exerts protective action by increasing the synthesis of mucosal growth factors, mucosal microcirculation, and by angiogenic actions [37]. Colloidal bismuth subcitrate accelerates ulcer healing by the

formation of occlusive complexes and the accumulation of epidermal growth factor (EGF) in the ulcer crater [38].

Rebamipide is cytoprotective and enhances gastric mucus production, stimulates the release of endogenous prostaglandins, and inhibits the generation of ROS [39].

## Perspectives

Thanks to a declining prevalence of Hp infection and introduction of effective anti-Hp therapies, PUD frequency is decreasing [40], and NSAIDs-induced ulcers now emerge as the most important cause of PUD.

With regard to the increasing resistance rate of Hp and rising frequency of Hp<sup>-</sup> ulcers, novel therapies to strengthen the mucosal defense are urgently needed. New candidates to reinforce the mucosal defense include melatonin, probiotics, H<sub>2</sub>S, NO, and CO [41]. Melatonin enhances gastric microcirculation and exerts antioxidative effects on the gastric mucosa, independently of prostaglandin synthesis [42]. Some probiotics increase production of mucosal growth factors and reduce proinflammatory cytokines [43]. Finally, H<sub>2</sub>S, NO, and CO were shown to increase protective prostaglandins in gastroduodenal mucosa and inhibit the generation of proinflammatory cytokines [44].

## References

1. Malfertheiner P, Chan FK, McColl KE (2009) Peptic ulcer disease. *Lancet* 374:1449–1461
2. Konturek PC (1997) Physiological, immunohistochemical and molecular aspects of gastric adaptation to stress, aspirin and to H. pylori-derived gastrot toxins. *J Physiol Pharmacol* 48:3–42
3. Tytgat GNJ (2011) Etiopathogenetic principles and peptic ulcer disease classification. *Dig Dis* 29: 454–458
4. Choung RS, Talley NJ (2008) Epidemiology and clinical presentation of stress-related peptic damage and chronic peptic ulcer. *Curr Mol Med* 8(4):253–257
5. Milosavljevic T, Kostić-Milosavljević M, Jovanović I, Krstić M (2011) Complications of peptic ulcer disease. *Dig Dis* 29:491–493
6. Graham DY, Kato M, Asaka M (2008) Gastric endoscopy in the 21st century: appropriate use of an invasive procedure in the era of non-invasive testing. *Dig Liver Dis* 40(7):497–503
7. Schwarz K (1910) Über penetrierende Magen- und Jejunalgeschwüre. *Beitr Klin Chir* 67:96–128
8. Tarnawski AS, Ahluwalia A, Jones MK (2012) The mechanisms of gastric mucosal injury: focus on microvascular endothelium as a key target. *Curr Med Chem* 19(1):4–15
9. Graham DY, Lew GM, Klein PD, Evans DG, Evans DJ Jr, Saeed ZA, Malaty HM (1992) Effect of treatment of *Helicobacter pylori* infection on the long-term recurrence of gastric or duodenal ulcer. A randomized, controlled study. *Ann Intern Med* 116(9):705–708
10. Marshall BJ (1995) The 1995 Albert Lasker Medical Research Award. *Helicobacter pylori*. The etiologic agent for peptic ulcer. *JAMA* 274(13):1064–1066
11. Konturek PC, Konturek SJ, Bobrzynski A, Kwiecien N, Obtulowicz W, Stachura J, Hahn EG, Rembiarz K (1997) *Helicobacter pylori* and impaired gastric secretory functions associated with duodenal ulcer and atrophic gastritis. *J Physiol Pharmacol* 48(3): 365–373
12. McColl KE, El-Omar E, Gillen D (2000) *Helicobacter pylori* gastritis and gastric physiology. *Gastroenterol Clin North Am* 29(3):687–703
13. Malfertheiner P, Leodolter A, Peitz U (2000) Cure of *Helicobacter pylori*-associated ulcer disease through eradication. *Baillieres Best Pract Res Clin Gastroenterol* 14(1):119–132
14. Takeuchi K (2012) Pathogenesis of NSAID-induced gastric damage: importance of cyclooxygenase inhibition and gastric hypermotility. *World J Gastroenterol* 18(18):2147–2160
15. Chan FKL, Leung WK (2002) Peptic ulcer disease. *Lancet* 360:933–941
16. Gisbert JP, Calvet X (2009) Review article: *Helicobacter pylori*-negative duodenal ulcer. *Aliment Pharmacol Ther* 30:791–815
17. Maity P, Biswas K, Roy S, Banerjee RK, Bandyopadhyay U (2003) Smoking and the pathogenesis of gastroduodenal ulcer-recent mechanistic update. *Mol Cell Biochem* 253(1–2):329–338
18. Franke A, Teyssen S, Singer MV (2005) Alcohol-related diseases of the esophagus and stomach. *Dig Dis* 23(3–4):204–213
19. Shimamoto T, Yamamichi N, Kodashima S, Takahashi Y, Fujishiro M, Oka M, Mitsushima T, Koike K (2013) No association of coffee consumption with gastric ulcer, duodenal ulcer, reflux esophagitis and non-erosive reflux disease: a cross-sectional study of 8,013 healthy subjects in Japan. *PLoS One* 8(6): e65996
20. Selgrad M, Malfertheiner P (2011) Treatment of *Helicobacter pylori*. *Curr Opin Gastroenterol* 27(6): 565–570
21. Chan FK, Ching JY, Suen BY, Tse YK, Wu JC, Sung JJ (2013) Effects of *Helicobacter pylori* infection on long-term risk of peptic ulcer bleeding in low-dose-aspirin users. *Gastroenterology* 144(34): 528–535

22. Malfertheiner P, Megraud F, O'Morain C, Bazzoli F, El-Omar E, Graham D, Hunt R, Rokkas T, Vakil N, Kuipers EJ (2007) Current concepts in the management of *Helicobacter pylori* infection: the Maastricht III Consensus Report. *Gut* 56(6):772–781
23. Sachs G, Shin JM, Hunt R (2010) Novel approaches to inhibition of gastric acid secretion. *Curr Gastroenterol Rep* 12(6):437–447
24. Holle GE (2010) Pathophysiology and modern treatment of ulcer disease. *Int J Mol Med* 25(4):483–491
25. Holster IL, Kuipers EJ (2011) Update on the endoscopic management of peptic ulcer bleeding. *Curr Gastroenterol Rep* 13:525–531
26. Lee CW, Sarosi GA Jr (2011) Emergency ulcer surgery. *Surg Clin North Am* 91(5):1001–1013
27. Ford AC, Delaney BC, Forman D, Moayyedi P (2006) Eradication therapy for peptic ulcer disease in *Helicobacter pylori* positive patients. *Cochrane Database Syst Rev* (2):CD003840
28. Graham DY, Calvet X (2012) Guide regarding choice of second-line therapy to obtain a high cumulative cure rate. *Helicobacter* 17:243–245
29. McColl KE (1997) *Helicobacter pylori* and acid secretion: where are we now? *Eur J Gastroenterol Hepatol* 9(4):333–335
30. Konturek SJ (1993) New aspects of clinical pharmacology of antacids. *J Physiol Pharmacol* 44(3 Suppl 1):5–21
31. Warner CW, McIsaac RL (1991) The evolution of peptic ulcer therapy. A role for temporal control of drug delivery. *Ann N Y Acad Sci* 618:504–516
32. Huang JQ, HRH (2001) Pharmacological and pharmacodynamic essentials of H<sub>2</sub>-receptor antagonists and proton pump inhibitors for the practising physician. *Best Pract Res Clin Gastroenterol* 15(3):355–370
33. Mössner J, Caca K (2005) Developments in the inhibition of gastric acid secretion. *Eur J Clin Invest* 35(8):469–475
34. Williams C, McColl KE (2006) Review article: proton pump inhibitors and bacterial overgrowth. *Aliment Pharmacol Ther* 23(1):3–10
35. Abraham NS (2012) Proton pump inhibitors: potential adverse effects. *Curr Opin Gastroenterol* 28(6):615–620
36. Reskin JB, White RH, Jackson JE, Weaver AL, Tindall EA, Lies RB, Stanton DS (1995) Misoprostol dosage in the prevention of non-steroidal anti-inflammatory drug-induced gastric and duodenal ulcers: a comparison of three regimens. *Ann Intern Med* 123:344–350
37. Konturek SJ, Brzozowski T, Majka J, Szlachcic A, Bielanski W, Stachura J, Otto W (1993) Fibroblast growth factor in the gastroprotection and ulcer healing: interaction with sucralfate. *Gut* 34(7):881–887
38. Hall DW (1989) Review of the modes of action of colloidal bismuth subcitrate. *Scand J Gastroenterol Suppl* 157:3–6
39. Song KH, Lee YC, Fan DM, Ge ZZ, Ji F, Chen MH, Jung HC, Bo J, Lee SW, Kim JH (2011) Healing effects of rebamipide and omeprazole in *Helicobacter pylori*-positive gastric ulcer patients after eradication therapy: a randomized double-blind, multinational, multi-institutional comparative study. *Digestion* 84:221–229
40. Konturek PC, Bielanski W, Konturek SJ, Hahn EG (1999) *Helicobacter pylori* associated gastric pathology. *J Physiol Pharmacol* 50(5):695–710
41. Al-Jiboury H, Kaunitz JD (2012) Gastroduodenal mucosal defense. *Curr Opin Gastroenterol* 28(6):594–601
42. Celinski K, Konturek SJ, Konturek PC, Brzozowski T, Cichoz-Lach H, Slomka M, Bielanski W, Reiter RJ (2011) Melatonin or L-tryptophan accelerates healing of gastroduodenal ulcers in patients treated with omeprazole. *J Pineal Res* 50(4):389–394
43. Konturek PC, Sliwowski Z, Koziel J, Ptak-Belowska A, Burnat G, Brzozowski T, Konturek SJ (2009) Probiotic bacteria *E. coli* Nissle 1917 attenuates acute gastric lesion induced by stress. *J Physiol Pharmacol* 60(Suppl 6):41–48
44. Wallace JL (2012) Hydrogen sulphide: a rescue molecule for mucosal defence and repair. *Dig Dis Sci* 57(6):1432–1434

---

# Gastroenteritis

Christina Quigley and Xi Jiang

---

## Introduction to Gastroenteritis

Diarrheal disease is responsible for significant morbidity and mortality worldwide, with nearly 1.7 billion cases [1] and at least two million deaths per year, many resulting from consumption of contaminated food [2]. Acute infectious gastroenteritis is defined as disorder of the physiological functions of stomach, small, and large intestine (see chapter “[Overview](#)” under part “Gastrointestinal tract”) due to inflammation of the digestive tract, resulting from bacterial, viral, or parasitic infections (Fig. 1). Noninfectious gastroenteritis may also occur after ingestion of certain types of food and medicines but is less common. Common symptoms include diarrhea, vomiting, abdominal pain, headache, nausea, fatigue, and occasionally fever and chills [3]. Infectious gastroenteritis can occur year-round, but bacterial cases are seen more commonly in warm or summer months because bacterial pathogens can replicate *in vitro* after contamination of food or water. These diseases are more common in developing nations where sanitation conditions are poor and visitors to these nations commonly develop traveler’s diarrhea. Viral pathogens are not able to replicate *in vitro*, but tend to survive longer in cold conditions, which facilitates their

spread via person-to-person contact. Therefore, viral diseases are more common in the fall/winter seasons when people are indoors more often [4].

---

## Pathophysiology of Gastroenteritis

### Bacteria

Normal bacterial flora populates the gut, increasing in numbers from the stomach to the distal colon (see chapter “[Overview](#)” under part “Gastrointestinal tract”) [5]. These bacteria are helpful to the human host by fermenting unused energy substrates; training the immune system; preventing growth of harmful, pathogenic bacteria; regulating the development of the gut; producing vitamins, like vitamin K<sub>2</sub>; and metabolizing estrogen and androgen hormones [6].

Bacterial gastroenteritis can result from invasion of the gut mucosal surface, attachment to mucosal surfaces and release of toxins, or by toxin production in food prior to ingestion.

Invasive bacterial strains, such as *Shigella* and *Campylobacter* sp., usually lead to mucosal ulceration (see chapter “[Peptic ulcer disease](#)”), abscess formation, and inflammation, which can occur due to invasion of the gut alone, but are exacerbated by toxin production [7]. This process results in severe diarrhea due to secretion of water and electrolytes, sometimes containing mucus and/or blood in the feces with fever, abdominal pain, and rectal tenesmus (a feeling of incomplete defecation), known as dysentery [4].

---

C. Quigley • X. Jiang (✉)  
Division of Infectious Diseases, Cincinnati Children’s  
Hospital Medical Center, MLC 7017,  
3333 Burnet Ave., Cincinnati, OH 45229, USA  
e-mail: [christina.quigley@cchmc.org](mailto:christina.quigley@cchmc.org);  
[jason.jiang@cchmc.org](mailto:jason.jiang@cchmc.org)

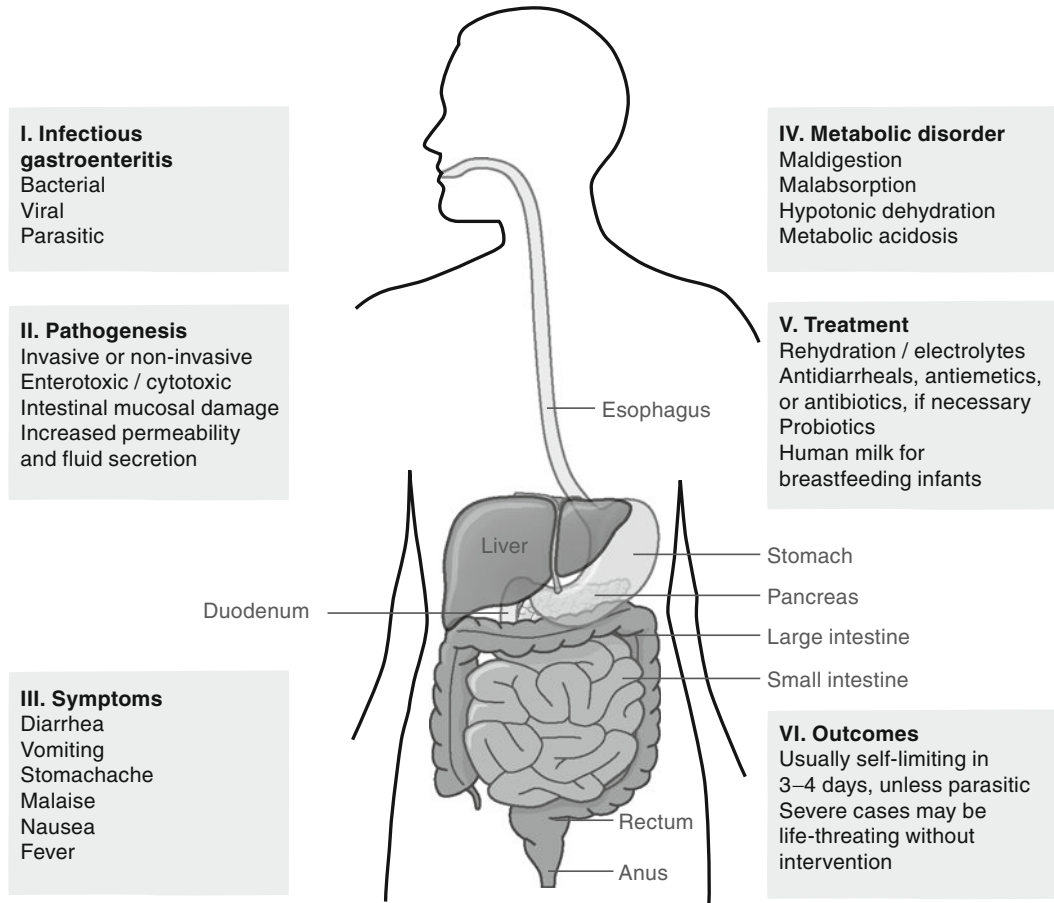

**Fig. 1** Overview of acute infectious gastroenteritis. Acute gastroenteritis is a disease affecting the stomach and small and large intestine (central panel). Causes of infectious gastroenteritis include bacterial, viral, and/or parasitic pathogens (I). These pathogens can be invasive and cause cell damage and produce toxins. Alternatively, the pathogens are noninvasive and damage mainly occurs through enterotoxin production (II). The resulting mucosal damage increases permeability and peristaltic movement and impairs intestinal absorption, resulting in diarrhea and other symptoms (III). The

major metabolic disorders include maldigestion and malabsorption due to impaired intestinal mucosal surfaces with consequences of hypotonic dehydration and metabolic acidosis, which can have severe complications (IV). Rehydration with proper electrolytes is critical for treatment. Antidiarrheals and antiemetics may provide relief from symptoms. Antibiotics are only used for bacterial and parasitic pathogens (V). Gastroenteritis is usually self-limiting in 3–4 days. Parasitic gastroenteritis may last longer. Life-threatening cases occur mostly in young children and the elderly (VI)

Noninvasive bacteria cause similar symptoms by adhering to the gut wall followed by production of enterotoxins, such as *Vibrio cholerae* and enterotoxigenic strains of *Escherichia coli*. Toxin production results in secretory diarrhea with a large volume of watery diarrhea characterized by excessive mucosal secretion due to adenylate cyclase induction resulting in impaired intestinal absorption [7]. In addition, cholera toxins bind to channel proteins, opening chloride channels,

which results in more chloride ions in the lumen of the small intestine and causes water to move into lumen, known as osmotic diarrhea [8].

Finally, some bacterial toxins, such as enterotoxins A to E from *S. aureus*, present in contaminated food [9] may cause symptoms similar to those of noninvasive bacteria, as enterotoxins are heat resistant and thus not destroyed by cooking. Nausea and vomiting may occur more frequently with this form of gastroenteritis



due to excessive gas formation and the body's response to purge the toxins.

In all forms of bacterial gastroenteritis, inflammation as the host's immune response to toxins or pathogens combined with variable entero- and cytotoxic effects can lead to mucosal cell damage and result in overall dysfunction of the gut with maldigestion of food and malabsorption of nutrients. In addition, overgrowth of some pathogenic bacterial strains may further exacerbate these effects on metabolism [10].

On average, the symptoms of bacterial gastroenteritis infections last between 2 and 10 days. Since patients are unable to reabsorb lost fluid, dehydration is the most common severe complication of acute gastroenteritis [11]. Thus, hospitalization is sometimes required in the pediatric and geriatric populations, although generally infections are self-limiting.

## Viruses

Acute viral gastroenteritis is one of the top 5 causes of death worldwide. The major viral gastroenteritis pathogens include rotavirus (RV), norovirus (NoV), astrovirus, and enteric adenovirus [12]. RV is the leading cause of severe diarrhea in children under 5 years with significant mortality in developing nations, although NoV also contributes [13]. In developed nations, NoV infections commonly occur in adults and are responsible for major outbreaks of acute gastroenteritis. These viral pathogens are typically invasive, infecting enterocytes, and cause cell death or toxic effects disturbing the normal function of the gut. Unfortunately, the precise pathogenic mechanisms of most of these viruses remain unknown [12]. RV uses sialic acid, several integrins, and heat shock cognate protein 70 as cell surface receptors, which facilitate virus penetration through the mucosal surface and infection [14]. This may cause structural changes, including villus shortening, which decreases the function of the small bowel mucosa, along with inflammation and mononuclear cell infiltration in the lamina propria (inner layer of the gut mucosa). These changes combined with cell damage lead

to maldigestion and malabsorption, similar to bacterial gastroenteritis. In addition, infected epithelial cells induce villus ischemia and activation of the enteric nervous system that further exaggerate the disease [15]. Recent studies of RV showed that the viral nonstructural protein 4 (NSP4) could act as an enterotoxin, the first identified in viral infections. NSP4 binds integrins  $\alpha1\beta1$  and  $\alpha2\beta1$  [14] and appears to trigger epithelial cell chloride secretion by increasing intracellular  $Ca^{2+}$  through phospholipase C activation [16]. NSP4 also disrupts tight junctions, which is believed to be a new mechanism of pathogenesis leading to malabsorption and dehydration via increased permeability [17]. Symptoms related to viral gastroenteritis usually last 1–3 days and are most often self-limiting. However, severe cases can be life-threatening due to severe dehydration [12].

## Parasites

The most common parasites responsible for gastroenteritis are *Giardia* and *Cryptosporidium*. Like bacteria, they can invade the intestinal mucosa or adhere to the gut wall. Subsequent inflammation and disruption of the gut mucosa lead to watery diarrhea, inadequate digestion of food, and malabsorption of nutrients [18]. The course of parasitic gastroenteritis is longer than both bacterial and viral gastroenteritis with symptoms lasting up to 4 weeks, even if the infection is cleared. It usually resolves without intervention. Due to the longer duration of symptoms, weight loss due to malabsorption, fatigue, and dehydration are commonly observed [11].

---

## Treatment of Gastroenteritis

In most cases of acute gastroenteritis, the infections resolve on their own. However, severe cases with serious dehydration such as those caused by RV infection can be life-threatening. Thus, the most important aspects of symptom management are rehydration and prevention of electrolyte loss. In developing countries where intravenous



**Table 1** Antibiotic treatment guidelines for bacterial and parasitic gastrointestinal infections

Pathogen	Treatment
<b>Bacterial</b>	
<i>Campylobacter</i> sp.	Erythromycin, if administered <4 day after symptom onset
<i>Clostridium difficile</i>	Avoid antibiotic (may prolong infection) Oral Metronidazole may be administered
<i>Escherichia coli</i>	Avoid antibiotic (may prolong infection or cause hemolytic-uremic syndrome)
<i>Salmonella</i> sp.	Antibiotic treatment not recommended for non-typhoid strains, except for immunocompromised patients Ampicillin may be used, but for resistant strains, third-generation Cephalosporins, Fluoroquinolones (not in children), or Trimethoprim-Sulfamethoxazole may be effective
<i>Shigella</i> sp.	Antibiotics not recommended for mild cases Ampicillin may be used for moderate to severe cases Trimethoprim-Sulfamethoxazole for resistant strains Fluoroquinolones for highly resistant strains
<i>Staphylococcus aureus</i>	Antibiotics ineffective (toxin present in contaminated food)
<i>Vibrio cholera</i>	Antibiotic selection is based on resistance
<b>Parasitic</b>	
<i>Cryptosporidium parvum</i>	Antibiotic dependent on age and general immune status
<i>Giardia intestinalis</i>	Commonly: Metronidazole, Paromomycin

rehydration is difficult to access, oral rehydration is strongly recommended [19]. The World Health Organization (WHO) recommendations include glucose electrolyte solutions or rice-based solutions, since they are easily accessible [20]. Other treatments to prevent dehydration include anti-diarrheal over-the-counter medications or prescription antiemetics if vomiting is severe [3]. Anti-diarrheal medications, such as loperamide (Imodium), bind opiate receptors in the gut, inhib-

iting release of acetylcholine and prostaglandins, thereby reducing peristalsis and increasing intestinal transit time [21]. Although this may allow increased water and electrolyte absorption, dehydration is still a risk and fluids should continue to be administered. The antiemetic ondansetron (Zofran) appears to decrease vomiting during acute gastroenteritis by inhibiting serotonin binding to 5-hydroxytryptamine (5-HT) receptors in the small intestine [22]. Probiotics, which consist of nonpathogenic strains of bacteria, are considered during acute gastroenteritis to help rebuild normal bacterial flora in the gut [23].

To combat the infection, feeding of human milk is recommended for breastfeeding infants [24], as it may contain antibodies against many bacterial and viral pathogens, which may reduce the infection [25]. In addition, human milk contains many carbohydrate glycans that may serve as decoy receptors for bacterial and viral pathogens that require a carbohydrate receptor to initiate infection [26].

Some bacterial and parasitic infections may require antibiotic intervention by ciprofloxacin or metronidazole, respectively, for clearance (Table 1). The WHO also recommends antibiotics for young children with bloody diarrhea and fever [27]. It is not generally recommended, however, as viruses remain unaffected.

Bismuth subsalicylate is used to treat diarrhea, since it may reduce secretions [28], bind free bacterial toxins [29], and exert topical effects on gut mucosa [4].

Finally, vaccination is a potential key to prevention. Two vaccines are available to prevent RV, which are highly recommended for children, while vaccines for NoV and others are under development.

## Influence of Treatment on Metabolism

Prompt rehydration is key to stop continued deterioration of the gut and restore normal metabolism. Without proper reabsorption of lost fluid due to mucosal damage, overall fluid deficit can rapidly lead to dehydration, which can lead

to hypovolemic shock, where the heart cannot efficiently pump blood through the body due to severe fluid deficits and even death [30]. Because dehydration is accompanied by loss of electrolytes, rehydration with proper solutions containing sufficient electrolytes is important. Insufficient electrolytes can alter neurologic and myocardial functions, while severe sodium excess (due to decreased water in dehydration) can lead to cerebrovascular damage, hemorrhage, and death [31]. Rehydration plus some antidiarrheal treatment will restore the body's normal functions allowing it to heal damaged mucosal surfaces of the gut. Proper digestion of food and absorption of nutrients also may help to restore the overall conditions of the gut, including normal bacterial flora. However, antidiarrheal treatments are contraindicated if symptoms include fever and/or bloody stool, as they can prolong or exacerbate bacterial infections [19]. Since antimotility agents increase bowel stasis, bacteria may proliferate, creating additional toxins and exacerbating gastroenteritis [32]. Antibiotic intervention also has limitations; because many prescribed antibiotics cannot distinguish between pathogenic bacteria and normal gut flora, treatment may also destroy endogenous bacteria and prolong maldigestion and malabsorption. Thus, more specific antibiotics showing a narrow spectrum (e.g., erythromycin against *Campylobacter* infections) are recommended [33].

---

## Perspectives

Prevention and rehydration are the keys for control of pathogenic acute gastroenteritis. Oral rehydration is critical for patients with severe symptoms and a large volume of body fluid loss. Washing of hands after toilet use and before meals is the most important hygiene practice to prevent spread of these diseases. Most diarrheal pathogens are resistant to environmental conditions and are carried by food and water.

Research on the mechanisms these pathogens use to persist in the environment and the procedures to prevent contamination of food and water are important areas for disease control

and prevention. Current research on NoV and RV recognition of human blood group antigens may shed new light on mechanisms of virus/host interactions, particularly for mucosal infection, potentially revealing new treatment approaches.

Further studies aim to understand the protection of some pathogens from disinfection procedures, such as UV,  $\gamma$ -irradiation, and high pressure. Although research of viral pathogens causing gastroenteritis remains difficult due to the inability to cultivate them *in vitro*, virus surrogates (replacements from other species closely related to human pathogens) provide an important new tool.

Most likely, cases of acute infectious gastroenteritis will continue to occur despite our best efforts to prevent them. Our hope is that increased availability to clean water sources and improved sanitary conditions in developing nations will decrease worldwide infection rates. New and improved vaccines may also decrease infection rates and/or hospitalizations, especially for viral infections. The constantly evolving knowledge and understanding of ideal treatment procedures will hopefully decrease mortality rates and frequency of complications due to acute infectious gastroenteritis.

---

## References

1. World Health Organization (2013) Diarrhoeal disease. Available from: <http://www.who.int/mediacentre/factsheets/fs330/en/index.html>. Accessed 21 June 2013
2. Kosek M, Bern C, Guerrant RL (2003) The global burden of diarrhoeal disease, as estimated from studies published between 1992 and 2000. *Bull World Health Organ* 81:197–204
3. Aranda-Michel J, Giannella RA (1999) Acute diarrhea: a practical review. *Am J Med* 106(6):670–676
4. Thielman NM, Guerrant RL (2004) Clinical practice. Acute infectious diarrhea. *N Engl J Med* 350(1):38–47
5. Hao W-L, Lee Y-K (2004) Microflora of the gastrointestinal tract. *Methods Mol Biol* 268:491–502
6. Festi D, Schiumerini R, Birtolo C, Marzi L, Montrone L, Scaioli E, Di Biase AR, Colecchia A (2011) Gut microbiota and its pathophysiology in disease paradigms. *Dig Dis* 29(6):518–524
7. Navaneethan U, Giannella RA (2008) Mechanisms of infectious diarrhea. *Nat Clin Pract Gastroenterol Hepatol* 5(11):637–647
8. Sellin JH (2001) The pathophysiology of diarrhea. *Clin Transplant* 15(Suppl 4):2–10

9. Le Loir Y, Baron F, Gautier M (2003) Staphylococcus aureus and food poisoning. *Genet Mol Res* 2(1):63–76
10. Schiller LR (2007) Evaluation of small bowel bacterial overgrowth. *Curr Gastroenterol Rep* 9(5):373–377
11. McClarren RL, Lynch B, Nyayapati N (2011) Acute infectious diarrhea. *Prim Care* 38(3):539–564
12. Clark B, McKendrick M (2004) A review of viral gastroenteritis. *Curr Opin Infect Dis* 17(5):461–469
13. Ramani S, Kang G (2009) Viruses causing childhood diarrhoea in the developing world. *Curr Opin Infect Dis* 22(5):477–482
14. López S, Arias CF (2004) Multistep entry of rotavirus into cells: a Versaillesque dance. *Trends Microbiol* 12(6):271–278
15. Ciarlet M, Gilger MA, Barone C, McArthur M, Estes MK, Conner ME (1998) Rotavirus disease, but not infection and development of intestinal histopathological lesions, is age restricted in rabbits. *Virology* 251(2):343–360
16. Dong Y, Zeng CQ-Y, Ball JM, Estes MK, Morris AP (1997) The rotavirus enterotoxin NSP4 mobilizes intracellular calcium in human intestinal cells by stimulating phospholipase C-mediated inositol 1,4,5-trisphosphate production. *Proc Natl Acad Sci* 94(8):3960–3965
17. Lorrot M, Vasseur M (2007) How do the rotavirus NSP4 and bacterial enterotoxins lead differently to diarrhea? *Virol J* 4(1):31
18. Huston CD (2004) Parasite and host contributions to the pathogenesis of amebic colitis. *Trends Parasitol* 20(1):23–26
19. Guerrant RL, Van Gilder T, Steiner TS, Thielman NM, Slutsker L, Tauxe RV, Hennessy T, Griffin PM, DuPont H, Sack RB, Tarr P, Neill M, Nachamkin I, Reller LB, Osterholm MT, Bennish ML, Pickering LK (2001) Practice guidelines for the management of infectious diarrhea. *Clin Infect Dis* 32(3):331–351
20. Practice parameter: the management of acute gastroenteritis in young children. American Academy of Pediatrics, Provisional Committee on Quality Improvement, Subcommittee on Acute Gastroenteritis (1996) *Pediatrics* 97(3):424–435
21. Sandhu BK, Tripp JH, Candy DC, Harries JT (1981) Loperamide: studies on its mechanism of action. *Gut* 22(8):658–662
22. Cubeddu LX, Trujillo LM, Talmaciu I, Gonzalez V, Guariguata J, Seijas J, Miller IA, Paska W (1997) Antiemetic activity of ondansetron in acute gastroenteritis. *Aliment Pharmacol Ther* 11(1):185–191
23. Preidis GA, Hill C, Guerrant RL, Ramakrishna BS, Tannock GW, Versalovic J (2011) Probiotics, enteric and diarrheal diseases, and global health. *Gastroenterology* 140(1):8–14
24. King CK, Glass R, Bresee JS, Duggan C, Centers for Disease Control and Prevention (2003) Managing acute gastroenteritis among children: oral rehydration, maintenance, and nutritional therapy. *MMWR Recomm Rep* 52(RR-16):1–16
25. Hayani KC, Guerrero ML, Morrow AL, Gomez HF, Winsor DK, Ruiz-Palacios GM, Cleary TG (1992) Concentration of milk secretory immunoglobulin A against Shigella virulence plasmid-associated antigens as a predictor of symptom status in Shigella-infected breast-fed infants. *J Pediatr* 121(6):852–856
26. Morrow AL, Ruiz-Palacios GM, Altaye M, Jiang X, Guerrero ML, Meinzen-Derr JK, Farkas T, Chaturvedi P, Pickering LK, Newburg DS (2004) Human milk oligosaccharides are associated with protection against diarrhea in breast-fed infants. *J Pediatr* 145(3):297–303
27. Singh A (2010) Pediatric emergency medicine practice acute gastroenteritis — an update. *Emerg Med Pract* 7
28. Gyles C, Zigler M (1978) The effect of adsorbant and anti-inflammatory drugs on secretion in ligated segments of pig intestine infected with Escherichia coli. *Can J Comp Med* 42(3):260–268
29. Ericsson CD, Evans DG, DuPont HL, Evans DJ, Pickering LK (1977) Bismuth subsalicylate inhibits activity of crude toxins of Escherichia coli and vibrio cholerae. *J Infect Dis* 136(5):693–696
30. Kreimeier U (2000) Pathophysiology of fluid imbalance. *Crit Care* 4(Suppl 2):S3–S7
31. Hirschhorn N (1980) The treatment of acute diarrhea in children. An historical and physiological perspective. *Am Journal Clin Nutr* 33(3):637–663
32. Church J, Fazio V (1986) A role for colonic stasis in the pathogenesis of disease related to Clostridium difficile. *Dis Colon Rectum* 29(12):804–809
33. Ternhag A, Asikainen T, Giesecke J, Ekdahl K (2007) A meta-analysis on the effects of antibiotic treatment on duration of symptoms caused by infection with campylobacter species. *Clin Infect Dis* 44(5):696–700

---

# Lactose Intolerance

Anthony K. Campbell and Stephanie B. Matthews

---

## Introduction to Lactose Intolerance

Lactose intolerance is a biochemical condition caused by the inability to digest fully the sugar in milk, i.e., lactose [1]. The condition of lactose intolerance is better described as “lactose sensitivity,” as everyone can tolerate some lactose, although this amount varies considerably between individuals [2]. It is essential to distinguish lactose intolerance from an allergy to milk proteins as there are major differences in the management of these two conditions and allergy occurs in 3–5 % of infants. Some four billion people around the world express low lactase levels (see below) and are thus potentially sensitive to lactose, suffering a range of gut and systemic symptoms (Fig. 1), unless diagnosed and then managed correctly. Lactose sensitivity is associated with two common gut conditions [3], irritable bowel syndrome (IBS, a disease characterized by abdominal pain, diarrhea, or constipation or both alternating) and inflammatory bowel disease (IBD, a group of inflammatory conditions affecting small intestine and colon, including Crohn’s

disease and ulcerative colitis) [4], and thus should be taken into account when diagnosing and treating these patients [5].

Lactose, galactose-1,4- $\beta$ -glucose, is only found naturally in significant amounts in mammalian milk (cow’s milk 49 g/l; human milk 70 g/l). Lactose is one sixth as sweet as sucrose and provides some 40 % of the energy requirements of a suckling infant. However, adults do not need lactose. Disaccharides (e.g., lactose, sucrose, and isomaltose) cannot be absorbed directly in the intestine, requiring an enzyme to cleave them into monosaccharides. Lactose is cleaved by lactase (lactase-phlorizin hydrolase), which occurs in the small intestinal microvilli. Galactose and glucose are subsequently absorbed into the enterocyte via the sodium-activated glucose transporter 1 (SGLUT1, also called SGLT1). Glucose and galactose are then taken up into the blood by the transporter GLUT2. Galactose is converted to glucose mainly by the Leloir pathway, where galactose is converted to UDP-glucose, particularly in the liver via galactose 1-phosphate (Gal-1-P) and UDP-galactose. Alternatively, humans can use the De Ley-Doudoroff pathway. Inherited mutations of enzymes in the Leloir pathway cause galactosemias, affecting 1 in 55,000 individuals. For example, galactosemia type 1 (galactose-1-phosphate uridylyltransferase deficiency) is seen in suckling infants causing severe illness, including not wanting to drink, vomiting, jaundice, hypoglycemia, enlarged liver (hepatomegaly), enlarged spleen (splenomegaly), proximal tubulus kidney damage, cataract, mental retardation, and failure to thrive.

---

A.K. Campbell (✉)

School of Pharmacy and Pharmaceutical Sciences,  
Cardiff University, Redwood Building,  
King Edward VII Avenue, Cardiff CB10 3NB, UK  
e-mail: [campbellak@cardiff.ac.uk](mailto:campbellak@cardiff.ac.uk)

S.B. Matthews

Welston Court Science Centre, Milton,  
Pembrokeshire SA70 8PS, UK  
e-mail: [matthewss6@cf.ac.uk](mailto:matthewss6@cf.ac.uk)

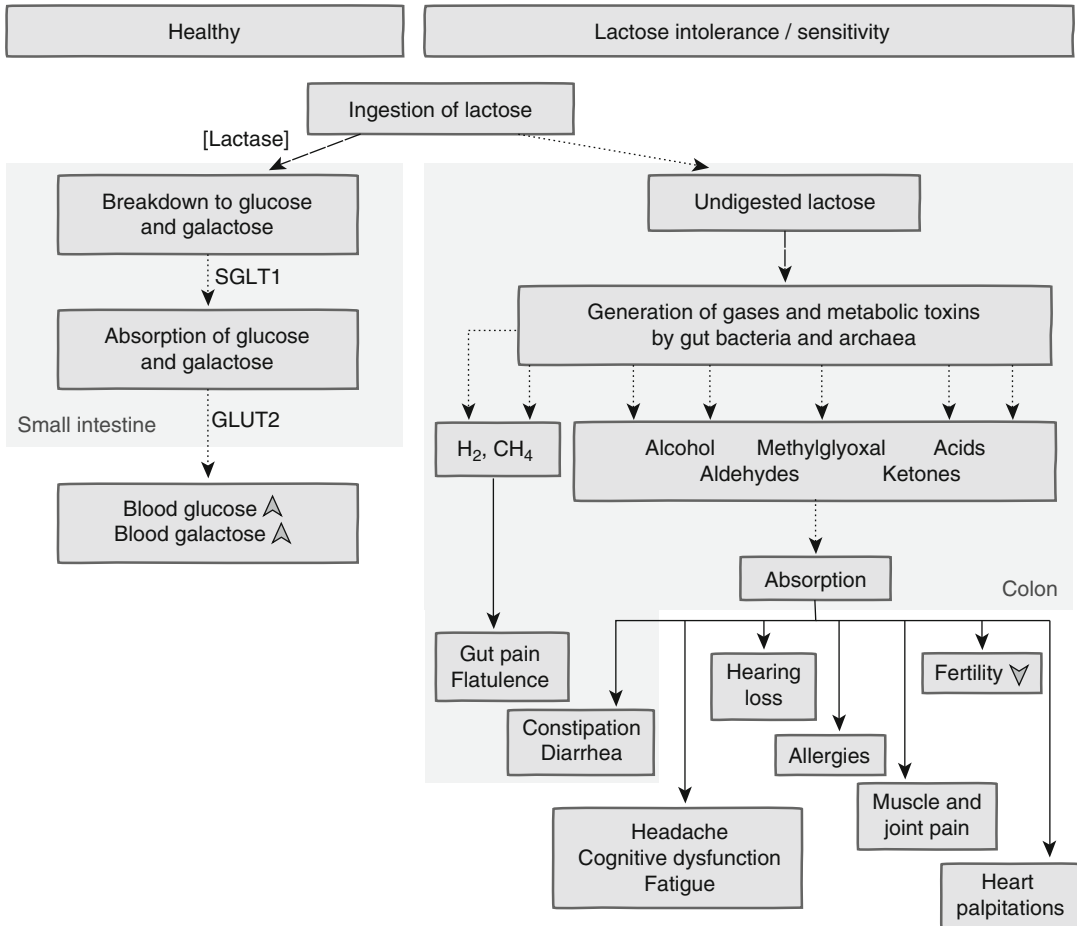

**Fig. 1** Main metabolic changes in lactose intolerance. Under healthy conditions, lactose is digested by lactase and incorporated causing an increase in blood glucose and galactose levels (*left side*). In patients who cannot hydrolyze lactose fully in the small intestine (lactose intolerant/sensitive, *right*

*side*), lactose is transferred to the large intestine and metabolized to metabolic toxins. The metabolic toxin groups are shown, with the respective gut and systemic symptoms. *SGLT1* sodium-activated glucose transporter 1, *GLUT2* glucose transporter 2,  $H_2$  hydrogen,  $CH_4$  methane

Galactose synthesis occurs mainly in the mammary gland, via the reversible conversion of UDP-glucose to UDP-galactose. UDP-galactose then reacts with glucose to form lactose, though 65 % of galactose for lactose comes from the blood. Galactose can also be synthesized *de novo* from glycerol. Galactose has an important role in cerebrosides.

SGLT1 is inhibited by tri- and tetrasaccharides (e.g., raffinose and stachyose) found in root vegetable, pulses, and soya. People who eat a lot of these can exhibit symptoms similar to hypolactasia (lack or reduced amounts of lactase).

A further problem is the increasing prevalence of sensitivity to fructose. There is an increased use of fructose as a sweetener in many foods and drinks, and sensitivity to fructose can lead to similar symptoms to those of lactose intolerance. Fructose is absorbed into the enterocyte by GLUT5. Like, glucose and galactose, fructose is transferred into the blood by GLUT2.

In diagnosis, hypolactasia is often overlooked and not tested for if the patient only complains of systemic symptoms, as opposed to gut symptoms. Yet, in many hypolactasia/lactose intolerant

patients, systemic symptoms can be more significant than those in the gut.

Interestingly, the symptoms that affected Charles Darwin for 50 years match exactly those of lactose intolerance [6]. Yet, he was never diagnosed because his doctors did not understand the link between the gut and the peripheral tissues.

Lactose intolerance is often confused in babies with allergy to milk proteins, particularly  $\alpha$ S1-casein, as symptoms are similar [1]. Protein allergy usually disappears by 3 years, whereas lactose intolerance can get worse with age. The allergy severity ranges from mild to anaphylactic (see chapter “Allergies”). Depending on the allergen, changing the origin of the milk, e.g., to goat’s milk, can be effective, though this is not always the case.

Additionally, many patients suffering from lactose intolerance are also sensitive to other substances in foods, the most common being wheat.

---

### Pathophysiology of Lactose Intolerance and Metabolic Alterations

There are five causes of hypolactasia: (1) congenital loss (very rare); (2) inherited loss on weaning, very common; (3) gut infections, such as rotavirus and *Giardia* (a monocellular parasite; see chapter “Gastroenteritis”); (4) damage to the villi in the small intestine caused by radiotherapy or bacterial overgrowth; and (5) hormonal disturbance (e.g., thyroid), menopause, and aging.

The first two of these are irreversible. In contrast, the last three potentially are reversible [1], after recovery from the gut infection, repair of damage to the villi, or treatment of the hormonal disturbance. Almost all mammals lose lactase after weaning [7]. Thus, inherited hypolactasia is very common, being as high as 90 % in Chinese and >80 % in Asians [1]. In evolution, apes would never see milk after coming off the mother’s breast. Lactase persistency in adult humans is only present in some ethnic groups, such as Bedouins and Northern Europeans (in which it reaches 90 %). Sensitivity to lactose generally increases with southern origins.

The loss after weaning correlates with two polymorphisms – C/T<sub>13910</sub> and G/A<sub>22018</sub> – occurring within introns of a helicase, upstream from the lactase gene on the long arm of chromosome 2 [8]. There is close correlation between the level of lactase and the C and G genotypes, those with CC and GG having the lowest levels. The molecular basis of this correlation is unknown. But, the key is the number of cells expressing lactase rather than the level of lactase in each cell [2]. In Chinese, the loss of lactase can be >90 % by the age of 5 years, but in other races it may take until teenage before the nadir of lactase is reached [1].

Hypolactasia causes a maldigestion of lactose in the small intestine. Lack of lactose uptake does not cause severe symptoms as the human body does not require lactose as such and can synthesize galactose in some non-mammary cells if required. However, undigested lactose is transported to the colon where it is subject to degradation by bacteria or archaeans forming gases such as hydrogen or methane and metabolic toxins such as methylglyoxal and other alcohols, diols, aldehydes, ketones, and acids [9]. Due to the variable tolerance of lactose between individuals [3] and the different degradation products, the resulting symptoms vary in type and severity (Fig. 1) [10].

Gas in the large intestine causes gut symptoms, like distension, borborygmi, and flatulence. Moreover, the metabolic toxins affect the balance of microflora in the gut and cause diarrhea or constipation. This surprising difference between diarrhea or constipation in particular patients reflects whether the bacterial metabolic toxins act to block smooth muscle contraction, and thus cause constipation, or act in an analogous way to cholera or enterotoxin to signal fluid secretion into the large intestine. After absorption into the blood, the bacterial metabolic toxins result in a multitude of systemic symptoms in peripheral tissues, ranging from fatigue, headache, cognitive dysfunction, muscle and joint pain to heart palpitations, exacerbation of allergies [11] (see chapter “Allergies”), and liver and kidney problems (see chapters “Overview” under the part

“Liver” and “**Overview**” under the part “Kidney”). These symptoms are the result of direct effects of the toxins on ionic signaling in peripheral tissues [9]. Most prominently, methylglyoxal reacts with hormones (e.g., insulin) and neurotransmitters (e.g., serotonin and dopamine), inactivating them [9], a biochemical process called Pictet-Spengler reaction. Methylglyoxal also acts on neurons directly, causing pain.

Lactose intolerance is associated with IBS [5] and IBD [4]. The symptoms in IBS are a result of poor lactose digestion and sugar absorption in the small intestine. In IBD, it is not clear whether lactose intolerance is a cause or consequence of the intestinal inflammation. Although there are endogenous mechanisms capable of inactivating bacterial toxins, their role in lactose intolerance, IBS, and IBD is as yet unknown.

### Treatment of Lactose Intolerance

Treatment depends on the reason for the hypolactasia. Failure to treat correctly may leave patients with long-term damage to the intestine or other tissues and also other conditions, such as IBD or celiac disease.

As congenital loss and loss after weaning cannot be “reactivated,” avoidance of lactose in the diet is, in general, inevitable (Fig. 2) [2]. This is difficult, however, because lactose is “hidden” in many foods and drinks, not normally associated with milk (e.g., chocolate, bread, biscuits, processed meat) [3]. It is used in processed foods because it improves shelf life, browning, mouth feel, and flavor. As filler, lactose bulks up expensive ingredients and often replaces fat removed from products in low-fat alternatives.

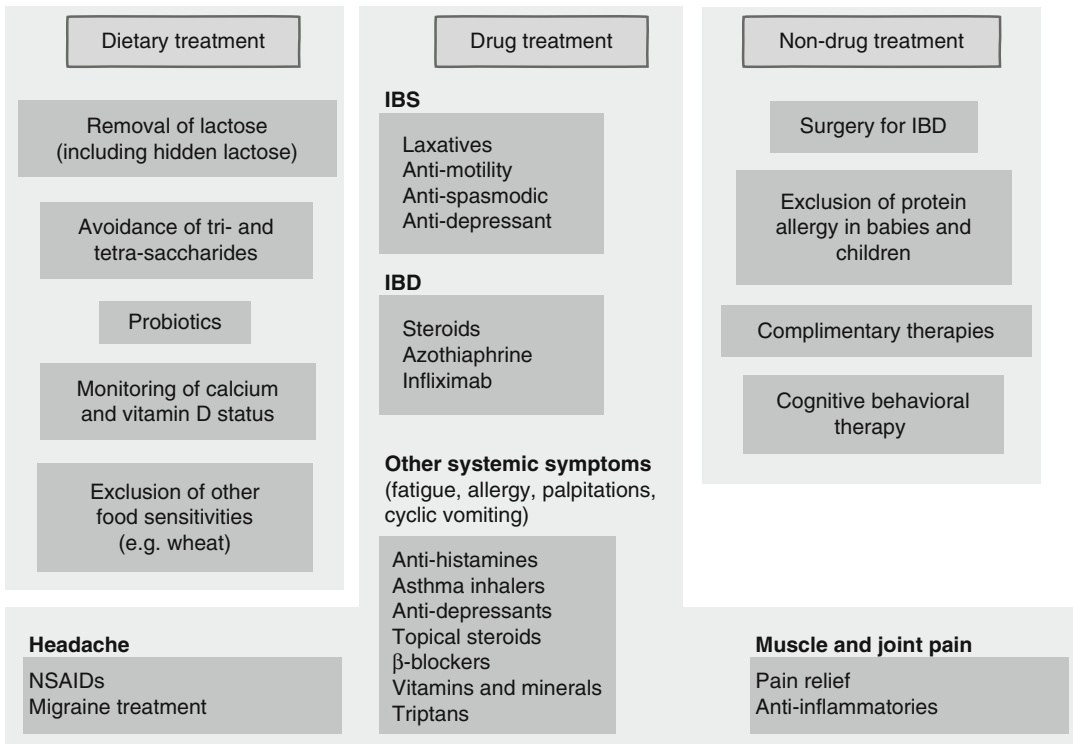

**Fig. 2** Influence of disease treatments on disease. Three general types of treatment are available for the various symptoms in lactose-sensitive patients: (1) dietary manipulation, particularly lactose exclusion; (2) drugs, which are often not very effective, if at all; and (3) nondrug therapy. The most effective and common treatment is removal of lactose from the diet. Other dietary restrictions might

be helpful, as well. Comorbidities and symptoms are often targeted using specific drugs. Cognitive behavioral therapy involves discussions with a psychologist, using standard psychological methods. Complimentary therapies involve acupuncture, reflexology, and exercise. *IBS* irritable bowel syndrome, *IBD* inflammatory bowel disease, *NSAIDs* nonsteroidal anti-inflammatory drugs



Labeling of added lactose is poor as it is commonly part of “flavorings” or “added sugar,” being described as “natural.” It is possible to take the equivalent of a liter of milk in “hidden” lactose, for example, after starting a weight loss regime using meal substitute drinks high in lactose. Symptoms of lactose intolerance are often aggravated by tri- and tetrasaccharides inhibiting SGLUT1 (see above) and leading to unabsorbed sugars reaching the bacteria in the large intestine.

Natural yogurt is often tolerated, since the lactose content is much reduced. Substitutes, such as lactose-free cow’s milk or soya milk, are generally useful, if soya intolerance is excluded.

Symptoms caused only by lactose can disappear within a few days after removing lactose from the diet.

Alternatively, the enzyme marketed as “lactase,” actually  $\beta$ -galactosidase, taken before eating lactose, may alleviate symptoms, as it is supposed to digest lactose similar to the endogenous enzyme.  $\beta$ -galactosidase also hydrolyses lactose to galactose and glucose and is expressed in many bacteria and several molds. Yet, it has no sequence similarity to mammalian lactase, contains only one active center for lactose, and cannot hydrolyze cerebrosides (also known as monoglycosylceramides) as lactase does. The use of  $\beta$ -galactosidase is not routinely recommended, as most of the enzyme is degraded in the stomach. Timing and dose are critical to be effective.

Despite the best therapeutic approach of a lactose-free diet being drug free, many drugs are prescribed, or bought over the counter by people with lactose sensitivity, in an attempt to alleviate gut and systemic symptoms, the most common being IBS.

Treatment of IBS includes antispasmodics (e.g., mebeverine); bulk laxatives; antimotility drugs (e.g., loperamide); antidepressants (e.g., the tricyclic amitriptyline or a serotonin reuptake inhibitor), which reduce pain and cramps; and analgesics. Probiotics can also reduce symptoms [12]. Patients often also take antacids and proton pump inhibitors to reduce stomach acidity and reflux. However, these have

little or no consistent effect on the gut and systemic symptoms caused by lactose. Non-drug treatments of IBS include cognitive behavioral therapy; stress management; complementary therapies, including acupuncture and reflexology; and exercise.

Lactose sensitivity is commonly seen in IBD [4]. IBD treatment involves aminosalicylates, corticosteroids, and immunosuppressants. These are used to reduce the effect of inflammation in the intestine, but do not alleviate the symptoms caused by lactose.

---

### **Influence of Treatment on Metabolism and Consequences for Patients**

Removal of lactose from the diet or uptake of digesting enzymes does not have adverse effects on the patient’s metabolism. It is vital to ensure calcium and vitamin D levels when milk, their major dietary source, is avoided. Advice on the possible use of probiotics is also required. However, dietary removal of lactose may not solve all the problems, if the patient is intolerant to other foods. These need to be identified and treated, most commonly by dietary means.

The systemic symptoms of lactose intolerance lead to unnecessary drug usage. Headaches are treated by regular analgesics and the risk of overuse is high. Migraine and cyclical vomiting syndrome can be controlled by regular  $\beta$ -blockers and triptans (see chapter “[Migraine and cluster headache](#)”). Other commonly used drugs are antihistamines, anti-inflammatories, steroids, and asthma inhalers, taken to alleviate allergic symptoms (see chapter “[Asthma](#)”). Yet, unknown to most asthmatics, many inhalers also contain significant amounts of lactose.

Drug interaction from polypharmacy is a serious potential risk, especially as many of the drugs are self-prescribed. There is also a danger of drug overuse. Furthermore, there can be an iatrogenic problem of taking too much lactose in drugs, as it is often included in pills, which then contributes to morbidity [13].



## Perspectives

In diagnosis, the gold standard [5] for a patient presenting with unexplained gut and systemic symptoms should first be to test for the polymorphism C/T<sub>13910</sub>. All CC should immediately change to a lactose-free diet, whereas CT or TT patients should undergo a hydrogen and methane breath test after lactose ingestion, together with a record of symptoms. A significant number of patients show no positive hydrogen or methane breath test, but will exhibit symptoms after lactose ingestion. Hypolactasia caused by infections, e.g., *Giardia* or rotavirus, which damage the lactase-containing intestinal villi (see chapter “[Overview](#)” under the part “Gastrointestinal tract”), or hormonal imbalance, which can reduce lactase levels, should be investigated, if there is no evidence of family history. If the breath hydrogen or methane is increased, together with induction of symptoms by lactose, the patient should change to a lactose-free diet. All patients with a significant increase in symptoms after the lactose load should undergo a supervised trial to determine their lactose threshold. Every patient should be followed up in 12 weeks for a definitive diagnosis, based on clinical improvement, following lactose removal from the diet.

Lactose sensitivity, and the production of metabolic toxins by gut bacteria and archaeans, provides a new mechanism linking the gut to other illnesses, such as type 2 diabetes (see chapter “[Diabetes mellitus](#)”), Parkinson’s disease (see chapter “[Parkinson’s disease](#)”), Alzheimer’s disease (see chapter “[Alzheimer’s disease](#)”), some cancers (see chapter “[Overview](#)” under the part “[Cancer](#)”), and periodontal disease. The molecular mechanisms responsible for the production of bacterial metabolic toxins are a good target for drug discovery in developing a new treatment for these conditions.

## References

1. Campbell A, Jenkins-Waud J, Matthews S (2005) The molecular basis of lactose intolerance. *Sci Prog* 92: 241–287
2. Campbell AK, Matthews SB (2005) Tony’s lactose free cookbook: the science of lactose intolerance and how to live without lactose. The Welston Press, Pembrokeshire, p 204
3. Matthews SB, Waud JP, Roberts AG, Campbell AK (2005) Systemic lactose intolerance: a new perspective on an old problem. *Postgrad Med J* 81:167–173
4. Eadala P, Matthews SB, Waud JP, Green JT, Campbell AK (2011) Association of lactose sensitivity with inflammatory bowel disease – demonstrated by analysis of genetic polymorphism, breath gases and symptoms. *Aliment Pharmacol Ther* 34:735–746
5. Waud JP, Matthews SB, Campbell AK (2008) Measurement of breath hydrogen and methane, together with lactase genotype, defines the current best practice for investigation of lactose sensitivity. *Ann Clin Biochem* 45:50–58
6. Flatz G (1987) Genetics of lactose digestion in humans. *Adv Hum Genet* 16:1–77
7. Enattah NS, Sahi T, Savilahti E, Terwilliger JD, Peltonen L, Jarvela I (2002) Identification of a variant associated with adult-type hypolactasia. *Nature Genet* 30(2):233–237
8. Campbell AK, Matthews SB, Vassell N, Cox C, Naseem R, Chaichi MJ, Holland IB, Wann KT (2010) Bacterial metabolic ‘toxins’: a new mechanism for lactose and food intolerance, and irritable bowel syndrome. *Toxicology* 278(3):268–276
9. Matthews SB, Campbell AK (2000) When sugar is not so sweet. *Lancet* 355(9212):1330
10. Grimbacher B, Peters T, Peter HH (1997) Lactose intolerance may induce severe chronic eczema. *Int Arch Allergy Immunol* 113(4):516–518
11. Zuccotti G (2008) Probiotics in clinical practice: an overview. *J Int Med Res* 36(1):1–53
12. Eadala P, Waud JP, Matthews SB, Green JT, Campbell AK (2009) Quantifying the ‘hidden’ lactose in drugs used for the treatment of gastrointestinal conditions. *Aliment Pharmacol Ther* 29(6):677–687
13. Campbell AK, Matthews SB (2005) Darwin’s illness revealed. *Postgrad Med J* 81(954): 248–251

---

# Colorectal Cancer

Kishore Vipperla and Stephen J. O’Keefe

---

## Introduction to Colorectal Cancer

Colorectal cancer (CRC) is the most common gastrointestinal cancer. It is the second most common cancer in men and third most common in women by incidence. It represents the fourth most common cause of cancer mortality in both sexes worldwide [1]. It is mainly a disease of the western civilization with almost 60 % of the cases recorded in the developed countries. Nearly 90 % of CRCs are sporadic and caused by a complex interplay between genetic, host, and (most importantly) dietary factors. A “western” diet rich in red and processed meat and animal fat and of low fiber content is a well-recognized risk factor [2]. Recent research has further highlighted the key role of microbiota in mediating the dietary risk of colon cancer [3]. In addition, other environmental factors such as alcohol and smoking, inflammatory bowel disease, and obesity increase the CRC risk [4].

---

K. Vipperla  
Division of General Internal Medicine,  
University of Pittsburgh Medical Center,  
200 Lothrop Street, 933W MUH,  
Pittsburgh, PA 15213, USA  
e-mail: [vipperlak@upmc.edu](mailto:vipperlak@upmc.edu)

S.J. O’Keefe (✉)  
Division of Gastroenterology, Hepatology, and Nutrition,  
University of Pittsburgh School of Medicine,  
200 Lothrop Street, PUH Mezzanine Level – C Wing,  
Pittsburgh, PA 15213, USA  
e-mail: [sjokeefe@pitt.edu](mailto:sjokeefe@pitt.edu)

---

## Pathophysiology of Colorectal Cancer

CRC results from a stepwise accumulation of genetic defects and clonal proliferation of mutated colonic epithelial cells in an adenoma-carcinoma transformation sequence of normal colonic mucosa, a protuberant growth known as polyp or adenoma (Fig. 1), and ultimately adenocarcinoma [5]. Mutations of the adenomatous polyposis colon (APC) tumor suppressor gene are the most common (~80 %) genetic defects observed in sporadic CRC. The non-mutated protein product of the APC gene prevents the accumulation of  $\beta$ -catenin protein, its nuclear translocation, and inappropriate activation of gene transcription via the canonical Wnt pathway that promotes cell proliferation [6]. A plethora of carcinogens, e.g., present in tobacco smoke, reach the colonic mucosal epithelium and cause genetic mutations. Poor folate intake among heavy alcoholics and interference of its absorption by alcohol can result in genetic defects from impaired folate-mediated DNA synthesis, DNA methylation, and repair processes [7]. The proliferative influence of high levels of insulin-like growth factors (IGF-1 and IGF-2) on colonocytes during hyperinsulinemia and inflammation is believed to contribute to a higher CRC risk in obesity (see chapter “[Metabolic syndrome](#)”) [8]. There is also a convincing evidence of a positive association between consumption of red and processed meat and CRC, whereas

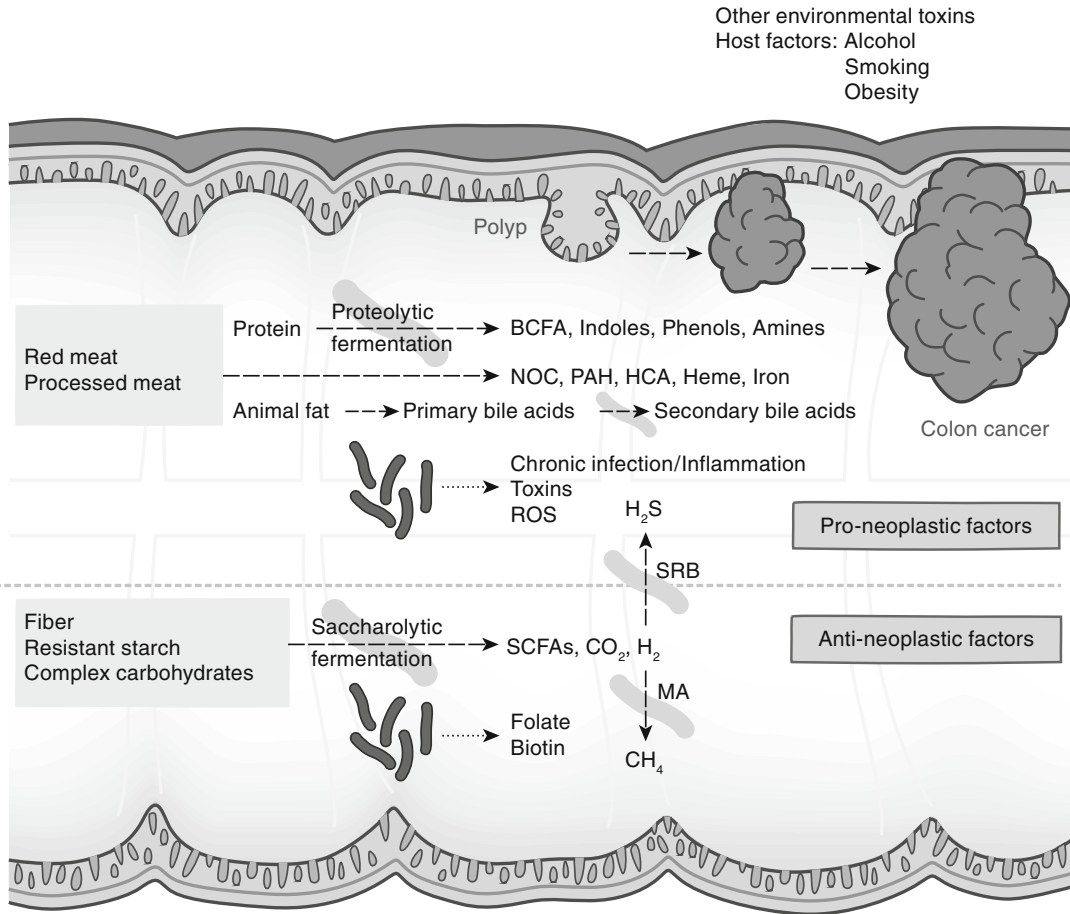

**Fig. 1** Dietary factors and microbial metabolites mediating the risk of colorectal cancer. The balance between health-promoting and proinflammatory metabolites determines the risk of colorectal cancer (CRC). Their production is dependent on both food compositions and (food metabolizing) microbiota. High fiber and resistant starch diet promote saccharolytic bacterial fermentation and enhance production of anti-inflammatory short-chain

fatty acids (SCFAs), whereas high dietary red meat and fat promote production of proinflammatory proteolytic bacterial fermentation end products and carcinogenic secondary bile acids. MA methanogenic archaea, SRB sulfate-reducing bacteria, BCFA branched-chain fatty acids, NOC N-Nitroso compounds, PAH polyaromatic hydrocarbons, HCA heterocyclic amines, ROS reactive oxygen species

dietary fibers appear to be protective (Fig. 1) [9]. Evidence supporting the cancer-protective effect of dietary components such as vitamin D, folate, fish, fruits, vegetables, and selenium is suggestive but limited. Interestingly, colonic microbiota (see chapter “Overview” under the part “Gastrointestinal tract”) seem to play a crucial role in mediating the influence of diet on CRC (see below).

### Pathophysiologic Role of the Colonic Microbiota and Its Metabolites

Beside its role in regulation of fluid conservation, electrolyte balance, and terminal conduit of undigested human excreta, the colon is inhabited by approximately 100 trillion microbes belonging to a diverse group of microorganisms, termed

microbiome, which holds a rich repertoire of metabolic functions [10]. In a symbiotic relationship, the microbiota are dependent on undigested food residues and in turn produces essential metabolites (see below).

The microbiota include ~800 different bacterial species with over 7,000 strains. Recent advances in molecular identification and characterization techniques have led to a better understanding of the microbial composition and appreciation of their metabolic potential [10]. Interestingly, microbial analyses revealed fundamentally different microbiomes among people of different origins, which even allow categorization into human fecal enterotype categories [11].

While ~90 % of protein and carbohydrate are digested and absorbed along the small intestine, residual food is metabolized by the colonic microbiota through fermentation, producing protective and vital metabolites, such as short-chain fatty acids (SCFAs), or vitamins such as folate and biotin that are essential for DNA synthesis and repair. However, the microbiota can also produce toxins and detrimental metabolites such as hydrogen sulfide (H<sub>2</sub>S), reactive oxygen species (ROS), and secondary bile acids (BAs) promoting inflammation and neoplastic progression (see below).

Chronic inflammation is triggered and perpetuated by some microbiota through signaling pathways such as induction of Toll-like receptors, upregulation of cyclooxygenase-2 (COX-2), and activation of mitogen-activated protein kinases (MAPKs) that promote proinflammatory cytokine release, cell proliferation, genetic mutation, and neoplastic transformation [12]. It is the fine balance between the beneficial and harmful microbiota and their metabolites that determines the state of health versus disease (Fig. 1). A disturbed microbial composition and function result in a state of dysbiosis, a key predecessor of diseases such as diabetes (see chapter “[Diabetes mellitus](#)”), obesity (see chapter [Metabolic syndrome](#)), inflammatory bowel disease, and CRC.

Indeed, diet is the cause of over 90 % of gastrointestinal cancers, the risk differing significantly

based on dietary habits [13]. Whereas native Africans consume a diet rich in indigestible fiber and resistant starch and low in animal products, African Americans consume more animal protein, red meat, and saturated fat and lower amounts of complex carbohydrates, resulting in a ten times higher CRC incidence [14].

Indigestible fiber, resistant starch, and complex carbohydrates undergo saccharolytic fermentation predominantly in the proximal colon yielding SCFAs (acetate, propionate, and butyrate), ethanol, and gases such as carbon dioxide (CO<sub>2</sub>) and hydrogen (H<sub>2</sub>; Fig. 1) [15]. Acetate and propionate are the major (~85 %) fraction of SCFAs but are absorbed mostly into the systemic circulation, with acetate being taken up by the liver for cholesterol synthesis and propionate participating in gluconeogenesis [16]. Butyrate, on the other hand, is the most important pluripotent SCFA that exerts its principal actions locally in the colon serving as the chief energy source for the colonocytes, regulator of the epithelial growth and differentiation, and anti-inflammatory and antineoplastic factor [17]. It causes hyperacetylation of histones by inhibiting histone deacetylase and modulates transcription factors to regulate gene expression and cell function [18]. Its actions are also mediated by signaling pathways involving upregulation of peroxisome proliferator-activated receptor- $\gamma$  (PPAR $\gamma$ ), suppression of nuclear factor- $\kappa$ B (NF- $\kappa$ B) activation, and G-protein-coupled receptor signaling [16]. Finally, butyrate plays a critical role in reinforcing the gut mucosal defense barrier by enhancing mucin gene expression and induction of trefoil factors (i.e., secretory proteins with a short trefoil motif involved in mucosal stabilization, protection, and regeneration), antimicrobial peptides, and transglutaminase activity (that cross-links and stabilizes proteins) [19].

On the contrary, undigested protein residues reaching the distal colon undergo proteolytic fermentation by bacteria producing branched-chain fatty acids and inflammatory nitrogenous metabolites such as phenolic and indolic compounds that have been shown to cause colonocyte DNA

damage in experimental models (Fig. 1) [20]. High consumption of red meat promotes proteolytic fermentation by providing large amounts of undigested protein residues. Red meat is also responsible for increasing CRC risk in several other ways. Hydrogen ( $H_2$ ), produced during fermentation, is generally excreted in the breath (directly or as methane). However, it can also be converted to hydrogen sulfide ( $H_2S$ ) by sulfide-reducing bacteria using methionine and cysteine from animal protein [21].  $H_2S$  induces mucosal hyperproliferation and free radical-mediated genotoxicity, effects that can be reversed by butyrate [22]. Aromatic amino acids, which are abundant in red meat, undergo bacterial decarboxylation and N-nitrosation resulting in formation of N-nitroso compounds (NOC) [23]. In a rat model, dietary heme was shown to promote colonocyte proliferation by causing epithelial injury, inhibition of apoptosis, and crypt cell hyperplasia, the precursors of carcinogenesis [24]. In addition, meat processing and cooking practices that expose meat to very high temperatures also result in formation of several mutagens (such as NOC, polycyclic aromatic hydrocarbons, and heterocyclic amines) that cause DNA base alkylation and formation of base adducts, biomarkers of chemical carcinogenesis [23, 25].

Finally, high dietary fat increases BA synthesis and consequently BA transition to the colon allowing bacterial conversion to secondary BAs (such as deoxycholic acid and lithocholic acid), which have strong inflammatory properties and cause oxidative DNA damage and genomic instability of the colonocytes [26]. High-fat diet also stimulates delivery of sulfur-rich taurine conjugates to the colon promoting certain detrimental bacterial strains and inducing colitis by proinflammatory  $T_H1$ -mediated immune responses and bacterial by-products such as  $H_2S$  and secondary BAs [27].

---

## Treatment and Influence on Metabolism

### Prevention

In general, adopting a healthy lifestyle with increased physical activity, limited consumption

of alcohol, avoidance of tobacco use, and, most importantly, dietary modifications (see below) can mitigate CRC risk.

## Dietary Modifications for Minimizing Risk of Colorectal Cancer

In light of the decisive influence of diet on CRC risk, it is prudent to consume a balanced diet that can modulate the microbial composition to produce beneficial metabolites such as butyrate. Enhancing butyrate production can mitigate the mutagenic effects of secondary BAs, proliferative effects of  $H_2S$ , and DNA damage induced by red meat [28]. Chlorophyll (present in green leafy vegetables) has been shown to ameliorate the toxic effects of heme [29]. Increasing our dietary fiber, resistant starch, and complex carbohydrate content and moderating red meat and animal fat portions seem to be a simple step for promoting colonic mucosal health. This diet is well tolerated even if patients are used to a more traditional diet. Reduction of red meat does not disturb general metabolism. Our demand for dietary protein, important for our structural and metabolic needs, can quite easily be met by consumption of other protein-rich diets such as white meat, fish, and legumes.

## Cancer Screening and Chemoprevention

The adenoma-carcinoma sequence usually takes 7–10 years offering an adequate window period to screen and intervene. At least 60 % of deaths from CRC can be prevented by early detection of precancerous polyps through diligent screening of people who are 50 years or older (or earlier in case of higher risk) using high-sensitivity fecal occult blood testing (meaning detection of blood in the stool), flexible sigmoidoscopy (i.e., an investigation of the rectum and last third of the colon by insertion of a camera mounted on a flexible scope into the anus and its guidance through the rectum into the colon), and/or colonoscopy (or coloscopy, i.e., an endoscopic examination of the large bowel with a flexible tube inserted via

the anus) with the latter allowing the removal of polyps (surgical prevention) [30]. Several pharmacological agents such as aspirin and other nonsteroidal anti-inflammatory agents (NSAIDs), statins, calcium, vitamin D, selenium, and postmenopausal hormone replacement therapy potentially reduce the incidence or recurrence of adenoma (chemoprevention) [4]. Significant associated risks (e.g., gastrointestinal bleeding with NSAIDs) render chemoprevention less attractive for the general population, yet it can be considered when the potential benefits outweigh the risks especially in those with high CRC risk.

### Treatment of Colorectal Cancer

Surgery, chemotherapy (including targeted monoclonal antibody therapies), and/or radiotherapy are the common therapeutic modalities, utilized either alone or in combination. Tumor location and stage at diagnosis (local extent, spread to lymph nodes, or distant metastasis) determine the treatment strategy [31]. Surgery is the cornerstone of CRC treatment, and resection can be curative when the tumor is localized to the colon or rectum and sometimes even when isolated metastatic foci in the liver or lung are amenable to resection. Systemic chemotherapy is used in combination with surgery either postoperatively (adjuvant therapy) when regional lymph nodes are involved or preoperatively (neoadjuvant chemoradiotherapy; see also chapter “[Breast cancer](#)”) to shrink metastatic foci before resection. Chemotherapy alone is used to prolong survival and for palliation in non-resectable advanced or metastatic CRC patients. 5-Fluorouracil (5-FU) in combination with leucovorin, capecitabine, oxaliplatin, and irinotecan and monoclonal antibody therapy targeting vascular endothelial growth factor-A (bevacizumab; see also chapter “[Age-related macular degeneration](#)”) or epidermal growth factor receptor (cetuximab, panitumumab) are the traditional chemo-immunotherapeutic agents. Better screening and treatment options have helped to improve the 5-year survival rates for CRC to 90 % (local cancer), 70 % (regional spread), and 12 % (distant metastasis) based on the staging at diagnosis [32].

### Perspectives

Our ability to manipulate microbiota and their metabolic profiles in order to minimize CRC risk through administration of probiotics needs to be validated further through rigorous research. Moreover, better understanding of the molecular characteristics of CRC and their variations that can affect prognosis and response to treatment and development of novel-targeted antibody therapies in the present era of “personalized medicine” could enhance therapeutic success rates immensely. Advances in minimally invasive surgical techniques can help to improve tumor resectability and minimize surgical complications.

With the pandemic of obesity, the incidence rate of CRC is expected to rise. However, a preemptive strategy of addressing and mitigating the risk factors complemented by a diligent screening strategy can help to decrease the incidence of CRC.

### References

1. <http://globocan.iarc.fr/factsheets/cancers/colorectal.asp>. Worldwide Cancer Statistics. Last Accessed 14 Oct 13
2. Gonzalez CA, Riboli E (2010) Diet and cancer prevention: contributions from the European Prospective Investigation into Cancer and Nutrition (EPIC) study. *Eur J Cancer* 46:2555–2562
3. O’Keefe SJ, Ou J, Aufreiter S et al (2009) Products of the colonic microbiota mediate the effects of diet on colon cancer risk. *J Nutr* 139:2044–2048
4. Chan AT, Giovannucci EL (2010) Primary prevention of colorectal cancer. *Gastroenterology* 138:2029–2043
5. Vogelstein B, Fearon ER, Hamilton SR et al (1988) Genetic alterations during colorectal-tumor development. *N Engl J Med* 319:525–532
6. Schneikert J, Behrens J (2007) The canonical Wnt signalling pathway and its APC partner in colon cancer development. *Gut* 56:417–425
7. Giovannucci E (2004) Alcohol, one-carbon metabolism, and colorectal cancer: recent insights from molecular studies. *J Nutr* 134:2475S–2481S
8. Bardou M, Barkun AN, Martel M (2013) Obesity and colorectal cancer. *Gut* 62:933–947
9. Wiseman M (2008) The second World Cancer Research Fund/American Institute for Cancer Research expert report. Food, nutrition, physical activity, and the prevention of cancer: a global perspective. *Proc Nutr Soc* 67:253–256
10. Tremaroli V, Backhed F (2012) Functional interactions between the gut microbiota and host metabolism. *Nature* 489:242–249



11. Arumugam M, Raes J, Pelletier E et al (2011) Enterotypes of the human gut microbiome. *Nature* 473:174–180
12. Terzic J, Grivennikov S, Karin E, Karin M (2010) Inflammation and colon cancer. *Gastroenterology* 138:2101–2114
13. Doll R, Peto R (1981) The causes of cancer: quantitative estimates of avoidable risks of cancer in the United States today. *J Natl Cancer Inst* 66:1191–1308
14. O'Keefe SJ, Chung D, Mahmoud N et al (2007) Why do African Americans get more colon cancer than Native Africans? *J Nutr* 137:175S–182S
15. Cummings JH, Englyst HN (1991) Measurement of starch fermentation in the human large intestine. *Can J Physiol Pharmacol* 69:121–129
16. Roy CC, Kien CL, Bouthillier L, Levy E (2006) Short-chain fatty acids: ready for prime time? *Nutr Clin Pract* 21:351–366
17. Vipperla K, O'Keefe SJ (2012) The microbiota and its metabolites in colonic mucosal health and cancer risk. *Nutr Clin Pract* 27:624–635
18. Davie JR (2003) Inhibition of histone deacetylase activity by butyrate. *J Nutr* 133:2485S–2493S
19. Willemsen LE, Koetsier MA, Van Deventer SJ, Van Tol EA (2003) Short chain fatty acids stimulate epithelial mucin 2 expression through differential effects on prostaglandin E(1) and E(2) production by intestinal myofibroblasts. *Gut* 52:1442–1447
20. Hughes R, Magee EA, Bingham S (2000) Protein degradation in the large intestine: relevance to colorectal cancer. *Curr Issues Intest Microbiol* 1:51–58
21. Gibson GR, Macfarlane GT, Cummings JH (1993) Sulphate reducing bacteria and hydrogen metabolism in the human large intestine. *Gut* 34:437–439
22. Attene-Ramos MS, Wagner ED, Gaskins HR, Plewa MJ (2007) Hydrogen sulfide induces direct radical-associated DNA damage. *Mol Cancer Res* 5:455–459
23. Mirvish SS (1995) Role of N-nitroso compounds (NOC) and N-nitrosation in etiology of gastric, esophageal, nasopharyngeal and bladder cancer and contribution to cancer of known exposures to NOC. *Cancer Lett* 93:17–48
24. De Vogel J, Van-Eck WB, Sesink AL, Jonker-Termont DS, Kleibeuker J, Van Der Meer R (2008) Dietary heme injures surface epithelium resulting in hyperproliferation, inhibition of apoptosis and crypt hyperplasia in rat colon. *Carcinogenesis* 29:398–403
25. Cross AJ, Ferrucci LM, Risch A et al (2010) A large prospective study of meat consumption and colorectal cancer risk: an investigation of potential mechanisms underlying this association. *Cancer Res* 70:2406–2414
26. Bernstein C, Holubec H, Bhattacharyya AK et al (2011) Carcinogenicity of deoxycholate, a secondary bile acid. *Arch Toxicol* 85:863–871
27. Devkota S, Wang Y, Musch MW et al (2012) Dietary-fat-induced taurocholic acid promotes pathobiont expansion and colitis in IL10<sup>-/-</sup> mice. *Nature* 487:104–108
28. Fung KY, Cosgrove L, Lockett T, Head R, Topping DL (2012) A review of the potential mechanisms for the lowering of colorectal oncogenesis by butyrate. *Br J Nutr* 108:820–831
29. De Vogel J, Jonker-Termont DS, Van Lieshout EM, Katan MB, Van Der Meer R (2005) Green vegetables, red meat and colon cancer: chlorophyll prevents the cytotoxic and hyperproliferative effects of haem in rat colon. *Carcinogenesis* 26:387–393
30. Levin B, Lieberman DA, McFarland B et al (2008) Screening and surveillance for the early detection of colorectal cancer and adenomatous polyps, 2008: a joint guideline from the American Cancer Society, the US Multi-Society Task Force on Colorectal Cancer, and the American College of Radiology. *Gastroenterology* 134:1570–1595
31. Cunningham D, Atkin W, Lenz HJ et al (2010) Colorectal cancer. *Lancet* 375:1030–1047
32. Siegel R, Desantis C, Virgo K et al (2012) Cancer treatment and survivorship statistics, 2012. *CA Cancer J Clin* 62:220–241

---

**Part VI**

**Pancreas**



---

## Overview

Alexandra E. Folias and Matthias Hebrok

---

### Anatomy and Physiology of the Pancreas

Ingestion of a meal stimulates the physiological response to control the digestion, absorption, and assimilation of nutrients. The pancreas is integral to this process, communicating with other organs through hormones and metabolites to efficiently obtain and use energy sources [1]. Following the intake of food, the exocrine compartment (made up of acinar, duct, and centroacinar cells; Fig. 1) releases digestive fluid to facilitate the intestinal breakdown and absorption of nutrients [2]. In contrast, pancreatic endocrine cells ( $\alpha$ -,  $\beta$ -,  $\delta$ -, and pancreatic polypeptide cells) release hormones [3] that control how cells use and store energy fuels (i.e., glucose, lipids, and proteins) during different metabolic transitions (i.e., feeding, fasting, and exercise) [4].

Located in the abdominal region, the “head” of the pancreas is nestled in the curve of the small intestine (Fig. 1a), while the “tail” is situated next to the spleen [5]. The lobes of the pancreas surround a branching network of ducts that merge into one main tube that carries digestive enzymes (made by pancreatic acinar cells) and bicarbonate-rich fluid (made by pancreatic duct cells) across

the pancreas into the duodenum of the small intestine [2]. On a cellular level, exocrine acinar cells make up ~95 % of the pancreas and form flower-like clusters that connect with terminal ducts located at the tips of the ductal tree (Fig. 1b, c). Centroacinar cells line the edges of the terminal ducts and create an interface between duct and acinar cells (Fig. 1c) [2]. The endocrine cells of the pancreas aggregate in clusters to form islets of Langerhans that make up ~1–2 % of the pancreas (Fig. 1b, d). Human islets are mainly composed of four different hormone-secreting cell types,  $\alpha$ -cells (secreting glucagon; 20–30 % of the cells in the islet),  $\beta$ -cells (secreting insulin; 60–70 %),  $\delta$ -cells (secreting somatostatin; <10 %), and pancreatic polypeptide cells (secreting pancreatic polypeptide; <3–5 %) (Fig. 1d) [6]. Ghrelin-expressing  $\epsilon$ -cells are a fifth islet cell type that are rare in the adult pancreas but found primarily during gestational development [7, 8]. These islet endocrine cells are the major source of hormones responsible for regulating systemic energy levels and require an extensive capillary network to efficiently monitor, detect, and release hormones in a manner that accommodates the changing energy needs of the body [3].

---

### Pancreas-Specific Metabolic Pathways and Processes

Glucose is one of the three major metabolic fuels and is particularly important for satisfying quick energy demands. To use glucose and other energy

---

A.E. Folias • M. Hebrok (✉)  
Department of Medicine, UCSF Diabetes Center,  
513 Parnassus Avenue, HSW 1116, 0540,  
San Francisco, CA 94143, USA  
e-mail: [afolias@diabetes.ucsf.edu](mailto:afolias@diabetes.ucsf.edu);  
[mhebrok@diabetes.ucsf.edu](mailto:mhebrok@diabetes.ucsf.edu)

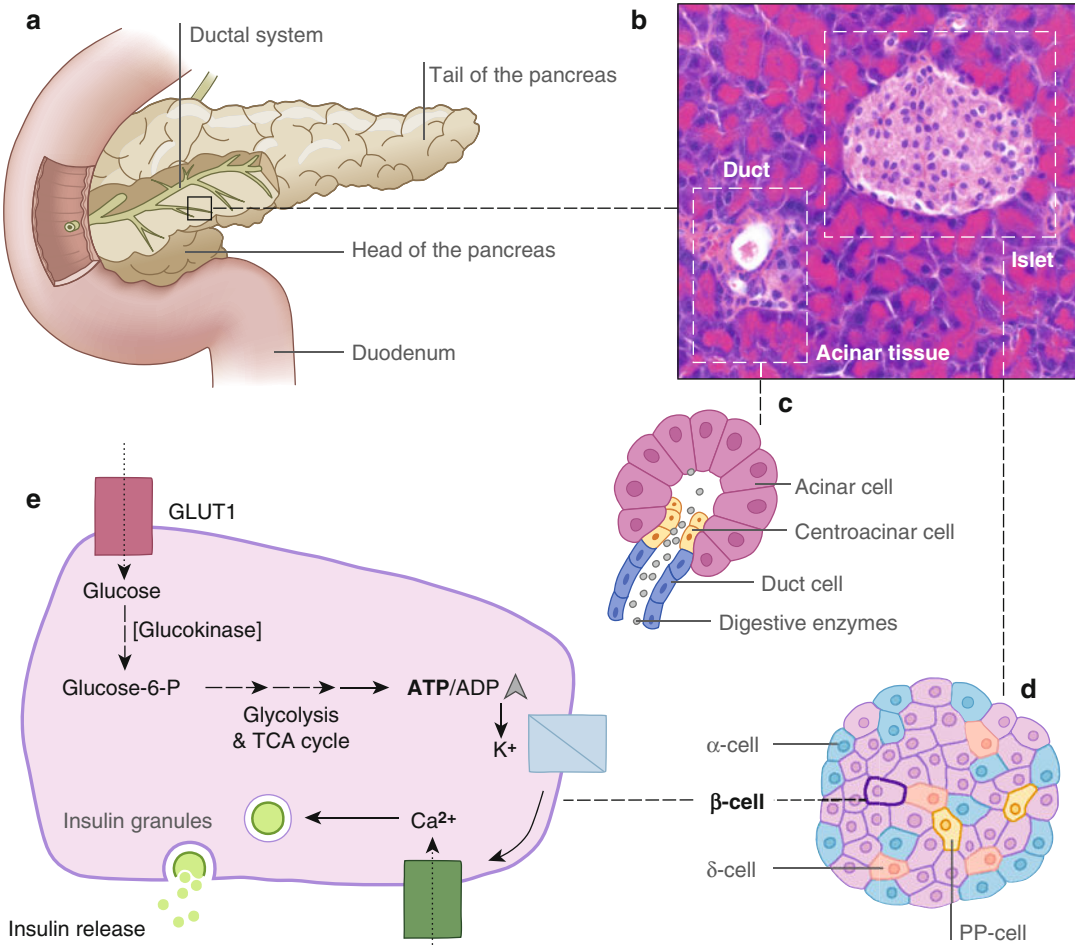

**Fig. 1** Anatomy of the pancreas. (a): Diagram showing the head of the pancreas located adjacent to the small intestine and the pancreatic ductal system that transports digestive enzymes into the duodenum of the intestine. (b): Microscopic image of the pancreas (stained with hematoxylin and eosin) showing the separated exocrine (acinar, centroacinar, and duct cells) and endocrine (islet cells) compartments. (c): Schematic of digestive enzyme release from the flower-like structure formed by acinar cells into a terminal duct lined with centroacinar cells. (d): Schematic of the four main hormone-secreting endocrine cells that make up the islets of Langerhans:  $\alpha$ -cells (glucagon),  $\beta$ -cells

(insulin),  $\delta$ -cells (somatostatin), and pancreatic polypeptide (PP) cells (pancreatic polypeptide). (e): Schematic of glucose-stimulated insulin secretion in a  $\beta$ -cell. Glucose enters the cell via glucose transporter 1 (*GLUT1*) and is phosphorylated by glucokinase and metabolized in glycolysis and the tricarboxylic acid (TCA) cycle. This increases cellular ATP and the ATP/ADP ratio inducing closure of the ATP-sensitive  $K^+$  channels. Subsequent depolarization of the cell causes voltage-gated  $Ca^{2+}$  channels to open and allows an influx of  $Ca^{2+}$  ions that stimulate the exocytosis of insulin secretory granules

sources, cells must first transport these nutrients from the bloodstream into the cell. The hormone insulin (synthesized and released by  $\beta$ -cells) is one of the main drivers of glucose uptake by tissues, and disruption in the synthesis, secretion, or signaling of insulin can lead to the manifestation of diabetes (see chapter “[Diabetes mellitus](#)”) [4]. Both serious long-term (heart disease, blindness)

and short-term (coma) complications can arise from hyperglycemia (elevated blood glucose) and hypoglycemia (too little blood glucose), highlighting the importance of regulating insulin release to maintain blood glucose levels within a specific range [1, 4].

Insulin is released in response to nutritional and hormonal signals, with the primary regulator

being glucose.  $\beta$ -cells use the metabolism of glucose as a way to determine both the levels of glucose present in the bloodstream and the corresponding amount of insulin to release in a process known as glucose-stimulated insulin secretion (Fig. 1e) [9]. As glucose is metabolized, ATP levels and thus the cellular ATP/ADP ratio increase, causing the ATP-sensitive  $K^+$  channels to close and a depolarization of the membrane. This change in membrane potential opens voltage-gated  $Ca^{2+}$ -channels. Influx of  $Ca^{2+}$  then triggers the exocytosis of secretory granules storing insulin (Fig. 1e). The released, active form of insulin is derived from the proteolytic cleavage of proinsulin that removes the C-peptide portion to allow direct association of the A and B chains via disulfide bonds [10].

To act as “glucose sensors,”  $\beta$ -cells can efficiently sample and metabolize a wide range of glucose levels. Glucose is first transported into the  $\beta$ -cell at levels proportional to the bloodstream by a transporter with low-affinity/high-capacity characteristics for glucose called glucose transport protein 1 (GLUT1, Fig. 1e) [11]. Glucose is subsequently phosphorylated to retain glucose inside the cell and allow entry into glycolysis. Hexokinase catalyzes this rate-limiting (slowest) step, acting as a regulator over the flux of the pathway [12]. There are several isozymes of hexokinase that differ in amino acid sequence but catalyze the same reaction. Glucokinase is the form of hexokinase expressed in the liver and insulin-secreting  $\beta$ -cells (Fig. 1e). In addition to tissue-specific expression, glucokinase also has a very high  $K_m$  (the substrate concentration that produces half-maximal velocity) for glucose in comparison to other hexokinases. This high  $K_m$  (10 mmol/l) allows the  $\beta$ -cell to metabolize and “sense” a range of glucose levels without becoming saturated. Other tissues, such as the brain, express a hexokinase with a significantly lower  $K_m$  (50  $\mu$ mol/l) for glucose to ensure the glycolytic needs of the brain are satisfied even during states of low blood glucose [13].

Additionally, characteristics of the subunits that make up the  $K_{ATP}$  channel also impact how insulin is secreted. The Kir6.2 ( $K^+$  inward rectifying)  $\alpha$ -subunits of the  $K_{ATP}$  channel contain an

inhibitory ATP-binding site, while the SUR1 (sulfonylurea receptor 1)  $\beta$ -subunits can induce closure of the channel independent of ATP levels in response to antidiabetic sulfonylurea drugs (see chapter “Diabetes mellitus”). In humans, elevated insulin release occurs with loss of function mutations in either SUR1 or Kir6.2, while decreased insulin secretion is found in cases of  $K_{ATP}$  activating mutations that hyperpolarize the  $\beta$  cell [14]. Ultimately, the fine-tuned interactions between glucose transport and glucokinase activity and the characteristics of the ATP-sensitive  $K^+$  channels and voltage-gated  $Ca^{2+}$  channels contribute to the threshold triggering insulin release in response to high blood glucose.

---

### Inside-In: Metabolites of the Pancreas Affecting Itself

The regulation of pancreatic hormone secretion directly occurs within the islet itself, tailoring the release of insulin and glucagon to match the diverse and fluctuating metabolic demands of the body. The anatomical organization of cells within the islet (Fig. 1d) is considered to be important for efficient function, allowing regulation to occur intimately via cell-cell interactions. Direct communication between  $\beta$  cells contributes to appropriate insulin release by inhibiting the basal release of insulin secretion but enhancing glucose-stimulated insulin secretion [15]. Additionally, as  $\beta$ -cells and  $\alpha$ -cells are activated under different metabolic conditions, release of factors from  $\beta$ -cells (insulin,  $\gamma$ -amino butyric acid, and zinc) [16, 17] can directly inhibit glucagon release from  $\alpha$ -cells [18]. Lastly, the intra-islet release of somatostatin from  $\delta$ -cells can inhibit both  $\alpha$ - and  $\beta$ -cell function, contributing to the fine-tuning of endocrine response to external signals [19, 20].

While endocrine hormones (such as pancreatic polypeptide released by  $\delta$ -cells) impact exocrine function, most of this regulation is believed to be via indirect mechanisms. However, there is some evidence that endocrine hormones can directly stimulate (insulin) or inhibit (somatostatin) exocrine enzyme release [21].

## Outside-In: Metabolites of Other Tissues Affecting the Pancreas

The intake of food stimulates both neuronal pathways, as well as the release of nutrients and gastrointestinal hormones that regulate how the endocrine and exocrine compartments of the pancreas function (see chapter “[Overview](#)” under the part “Gastrointestinal tract”). This molecular communication between the gastrointestinal organs is what couples food digestion with nutrient uptake and utilization in peripheral tissues.

Pancreatic release of digestive enzymes and endocrine hormones can be regulated by neurotransmitters and peptide hormones released by sympathetic (i.e., adrenergic; flight-or-fight response) and parasympathetic (i.e., cholinergic; rest and digest) neurons that innervate the pancreas [22]. Neuronal innervation affects insulin and glucagon secretion to stabilize blood glucose levels during states of stress, hypo- and hyperglycemia [18], as well as stimulates the release of insulin and digestive enzymes even before food has reached the gastrointestinal tract to optimize digestion efficiency [23].

Following food intake, intestinal hormones that regulate pancreatic function are released in response to the composition of dietary input. The hormone cholecystokinin, produced in the duodenum and jejunum of the small intestine (see chapter “[Overview](#)” under the part “Gastrointestinal tract”), stimulates acinar cells to manufacture and secrete digestive enzymes to facilitate macronutrient breakdown (Fig. 1c) [24]. As partially digested food moves through the duodenum, intestinal production of secretin stimulates the release of bicarbonate-rich fluid from pancreatic ductal cells to neutralize gastric acid and create an environment where pancreatic digestive enzymes can work effectively [23]. Incretins are gastrointestinal hormones released in response to orally ingested nutrients that affect insulin and glucagon release (see chapter “[Overview](#)” under the part “Gastrointestinal tract”) [5]. For example, glucagon-like peptide (GLP)-1 and glucose-dependent insulintropic polypeptide (GIP) are two major incretins that increase glucose-stimulated insulin secretion and

proliferation and survival of  $\beta$  cells. Additionally, GLP-1 suppresses glucagon release. Its levels increase rapidly in response to nutrient intake despite being released by cells located in the distal small intestine/colon. Since secretion of GLP-1 occurs before nutrients have reached this area, neural and/or endocrine factors are thought to trigger GLP-1 release [25].

GIP produced in the duodenum is also secreted in response to nutrient intake similarly to insulin, rising rapidly after food ingestion and declining during the fasted state [26], possibly explaining why oral glucose stimulates higher insulin release than intravenous glucose application.

Collectively, the beneficial effects of incretins, such as GLP-1 and GIP, on islet function have made these intestinal hormones attractive candidates for clinical use in patients with impaired blood glucose regulation.

---

## Inside-Out: Metabolites of the Pancreas Affecting Other Tissues

Optimal absorption of macronutrients requires digestion by enzymatic hydrolysis to yield monomers and oligomers that can be taken up by enterocytes in the small intestine (see chapter “[Overview](#)” under the part “Gastrointestinal tract”). Pancreatic enzymes are released into the duodenum to facilitate carbohydrate digestion (amylase), protein digestion (trypsin, chymotrypsin, carboxypolypeptidase, elastase) and lipid digestion (lipases and cholesterol esterase) [24]. To prevent degradation and harm to the pancreatic tissue, exocrine cells manufacture, store, and secrete digestive enzymes as proenzymes (inactive precursors) that are subsequently activated in the small intestine [1, 24]. Exocrine function is critical to nutrient absorption, and this is highlighted by the detrimental malabsorption that occurs in cases of exocrine insufficiency and decreased enzymatic output [24].

Glucose and other energy sources are absorbed after a meal (fed state) and released into the bloodstream and stimulate  $\beta$  cells to release insulin, the anabolic hormone that promotes the uptake and storage of glucose, lipids, and amino

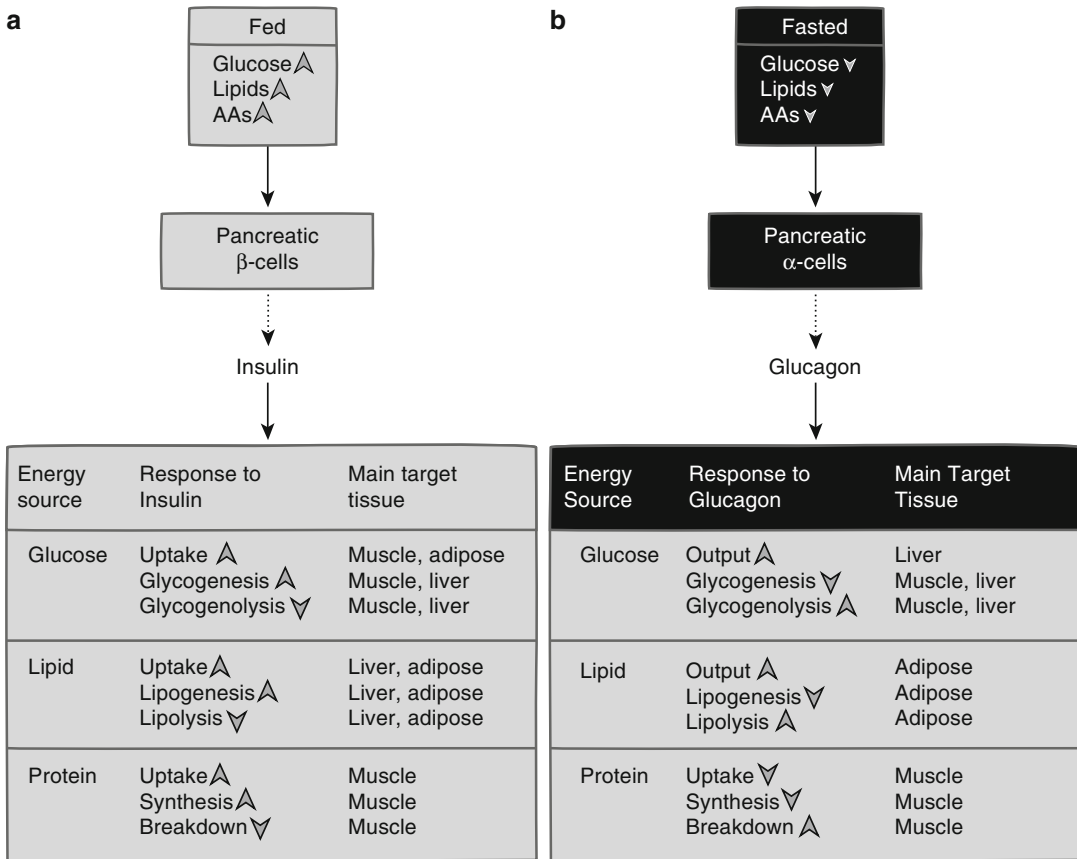

**Fig. 2** How pancreatic metabolites affect other tissues. (a): The anabolic hormone insulin is secreted by  $\beta$  cells when nutrient levels are high (fed state) to promote the uptake and storage of energy sources. (b): The catabolic

hormone glucagon released by  $\alpha$ -cells counter-regulates insulin by stimulating the mobilization of fuels, particularly glucose, during states of low fuel availability (fasting/exercise). AAs amino acids

acids (Fig. 2a). Insulin acts to promote the synthesis of glycogen (the storage form of glucose found in the muscle and liver, glycogenesis) as well as suppress glycogenolysis (glycogen breakdown). Additionally, fatty acid synthesis (lipogenesis) and protein synthesis are increased by insulin, while lipid breakdown (lipolysis) and protein breakdown are inhibited (Fig. 2a) [4]. Conversely, the catabolic hormone glucagon counter-regulates insulin by stimulating the mobilization of fuels, particularly glucose, during states of low fuel availability (fasting/exercise, Fig. 2b) [27]. Glucagon elevates blood glucose levels by stimulating hepatic glucose output via the breakdown of glycogen (glycogenolysis) as well as promoting the conversion of other carbon sources (pyruvate, lactate, glycerol,

and gluconeogenic amino acids) into glucose (gluconeogenesis). Unlike the liver, the glucose yielded from glycogen breakdown in the muscle is used only within the skeletal muscle. Additionally, glucagon also decreases processes that remove glucose from the bloodstream, including glycogenesis and glycolysis (Fig. 2b) [28].

### Final Remarks

Both the endocrine and exocrine compartments of the pancreas are vital to proper digestion, absorption, and assimilation of nutrients. The exocrine compartment (acinar, duct, and centroacinar cells) releases digestive enzymes and bicarbonate fluid to aid in the intestinal

breakdown of lipids, carbohydrates, and proteins. As these nutrients are absorbed, the endocrine cells of the islet ( $\alpha$ -,  $\beta$ -,  $\delta$ -, and pancreatic polypeptide cells) release hormones that affect how cells use and store these macronutrients. Insulin release by  $\beta$ -cells controls the uptake and storage of nutrients following a meal, while glucagon release by  $\alpha$ -cells promotes mobilization of energy stores during times when food intake is low. The importance of proper pancreatic function is highlighted by conditions that can occur in cases of exocrine insufficiency (nutrient malabsorption) and impaired endocrine function (diabetes, see chapter “[Diabetes mellitus](#)”).

## References

- Thompson JL, Manore MM, Vaughan LA (2008) The science of nutrition. Pearson Benjamin Cummings, San Francisco
- Reichert M, Rustgi AK (2011) Pancreatic ductal cells in development, regeneration, and neoplasia. *J Clin Invest* 121:4572–4578
- Murtaugh LC, Melton DA (2003) Genes, signals, and lineages in pancreas development. *Annu Rev Cell Dev Biol* 19:71–89
- Saltiel AR, Kahn CR (2001) Insulin signalling and the regulation of glucose and lipid metabolism. *Nature* 414:799–806
- Cummings DE, Overduin J (2007) Gastrointestinal regulation of food intake. *J Clin Invest* 117:13–23
- Cabrera O, Berman DM, Kenyon NS, Ricordi C, Berggren PO, Caicedo A (2006) The unique cytoarchitecture of human pancreatic islets has implications for islet cell function. *Proc Natl Acad Sci U S A* 103:2334–2339
- Arnes L, Hill JT, Gross S, Magnuson MA, Sussel L (2012) Ghrelin expression in the mouse pancreas defines a unique multipotent progenitor population. *PLoS One* 7:e52026
- Andralojc KM, Mercalli A, Nowak KW, Albarello L, Calcagno R, Luzi L, Bonifacio E, Doglioni C, Piemonti L (2009) Ghrelin-producing epsilon cells in the developing and adult human pancreas. *Diabetologia* 52:486–493
- Muoio DM, Newgard CB (2008) Mechanisms of disease: molecular and metabolic mechanisms of insulin resistance and beta-cell failure in type 2 diabetes. *Nat Rev Mol Cell Biol* 9:193–205
- Uchizono Y, Alarcón C, Wicksteed BL, Marsh BJ, Rhodes CJ (2007) The balance between proinsulin biosynthesis and insulin secretion: where can imbalance lead? *Diabetes Obes Metab* 9(Suppl 2): 56–66
- Matschinsky FM (2009) Assessing the potential of glucokinase activators in diabetes therapy. *Nat Rev Drug Discov* 8:399–416
- Matschinsky FM, Glaser B, Magnuson MA (1998) Pancreatic beta-cell glucokinase: closing the gap between theoretical concepts and experimental realities. *Diabetes* 47:307–315
- Murray RK, Granner DK, Mayes PA, Rodwell VW (2000) Harper’s biochemistry, 25th edn. Appleton and Lange, Stamford, pp 215–216
- Jentsch TJ, Hübner CA, Fuhrmann JC (2004) Ion channels: function unravelled by dysfunction. *Nat Cell Biol* 6:1039–1047
- Konstantinova I, Nikolova G, Ohara-Imaizumi M, Meda P, Kucera T, Zarbalis K, Wurst W, Nagamatsu S, Lammert E (2007) EphA-Ephrin-A-mediated beta cell communication regulates insulin secretion from pancreatic islets. *Cell* 129:359–370
- Ishihara H, Maechler P, Gjinovci A, Herrera PL, Wollheim CB (2003) Islet beta-cell secretion determines glucagon release from neighbouring alpha-cells. *Nat Cell Biol* 5:330–335
- Xu E, Kumar M, Zhang Y, Ju W, Obata T, Zhang N, Liu S, Wendt A, Deng S, Ebina Y, Wheeler MB, Braun M, Wang Q (2006) Intra-islet insulin suppresses glucagon release via GABA-GABAA receptor system. *Cell Metab* 3:47–58
- Gromada J, Franklin I, Wollheim CB (2007) Alpha-cells of the endocrine pancreas: 35 years of research but the enigma remains. *Endocr Rev* 28:84–116
- Rutter GA (2009) Regulating glucagon secretion: somatostatin in the spotlight. *Diabetes* 58:299–301
- Hauge-Evans AC, King AJ, Carmignac D, Richardson CC, Robinson IC, Low MJ, Christie MR, Persaud SJ, Jones PM (2009) Somatostatin secreted by islet delta-cells fulfills multiple roles as a paracrine regulator of islet function. *Diabetes* 58:403–411
- Barreto SG, Carati CJ, Toouli J, Saccone GT (2010) The islet-acinar axis of the pancreas: more than just insulin. *Am J Physiol Gastrointest Liver Physiol* 299:G10–G22
- Chandra R, Liddle RA (2012) Neurohormonal regulation of pancreatic secretion. *Curr Opin Gastroenterol* 28:483–487
- Williams JA (2010) Regulation of acinar cell function in the pancreas. *Curr Opin Gastroenterol* 26:478–483
- Keller J, Layer P (2005) Human pancreatic exocrine response to nutrients in health and disease. *Gut* 54(Suppl 6):1–28
- Drucker DJ (2006) The biology of incretin hormones. *Cell Metab* 3:153–165
- Yip GC, Wolfe MM (2000) GIP biology & fat metabolism. *Life Sci* 66:91–103
- Habegger KM, Heppner KM, Geary N, Bartness TJ, DiMarchi R, Tschöp MH (2010) The metabolic actions of glucagon revisited. *Nat Rev Endocrinol* 6:689–697
- Jiang G, Zhang BB (2003) Glucagon and regulation of glucose metabolism. *Am J Physiol Endocrinol Metab* 284:E671–E678



---

# Diabetes Mellitus

Alena Welters and Eckhard Lammert

---

## Introduction to Diabetes Mellitus

Diabetes mellitus (*diabetes* Greek, pass through/siphon; *mellitus* Latin, honey sweet) is a heterogeneous, multifactorial metabolic disorder characterized by chronic hyperglycemia. This is in part because insulin secretion is insufficient to maintain blood glucose levels in a physiological range [1]. On the one hand, diabetes can be diagnosed based on classical symptoms, i.e., polyuria (excessive production of urine) and polydipsia (excessive fluid intake) due to osmotic diuresis following glucosuria. The presence of glucose in urine is caused by blood glucose levels exceeding the capacity of renal tubular sodium-glucose linked transporters (SGLTs) to reabsorb glucose from the primary urine. On the other hand, the World Health Organization (WHO) criteria define diabetes either as a fasting blood glucose level at or above 7 mmol/l or as a level at or above 11.1 mmol/l 2 h post glucose challenge during an oral glucose tolerance test (2-h plasma glucose). The WHO further describes criteria of a prediabetes that comes with a strongly increased risk to develop diabetes. These include an impaired fasting blood glucose between 6.1 mmol/l and 6.9 mmol/l. In addition,

an impaired glucose tolerance as indicated by a 2-h plasma glucose between 7.8 mmol/l and 11 mmol/l or glycated hemoglobin between 5.7 and 6.4 % points to prediabetes [2].

Diabetes mellitus currently affects more than 350 million people worldwide, and the incidence continues to increase in both adults and children [3]. The disorder can be divided into two major classes: type 1 diabetes mellitus (T1DM), also known as juvenile diabetes, accounting for up to 10 % of all cases, and type 2 diabetes mellitus (T2DM), also known as adult-onset diabetes accounting for around 90 % of all cases. Additional classes include type 3 diabetes, which is subdivided into inherited monogenetic forms of diabetes (termed “maturity-onset diabetes of the young,” Type 3A) and drug- and chemical-induced diabetes (Type 3E), and type 4 diabetes, defined as the onset of glucose intolerance during pregnancy, termed gestational diabetes [4]. The latter occurs in approximately 7 % of pregnancies (range 1–14 %, depending on the population studied) and is associated with an increased risk for the development of T2DM later in life, for both mother and child [5].

In all types of diabetes, a combination of genetic predisposition and environmental factors contributes to the onset of diabetes. Moreover, all share common long-term complications, largely due to the elevated blood glucose levels that particularly affect the cardiovascular and nervous system (see chapters “[Overview](#)” under the part “Brain”, “[Overview](#)” under the part “Heart”, and “[Overview](#)” under the part “Blood vessels”).

---

A. Welters • E. Lammert (✉)

Department of Biology, Institute of Metabolic Physiology, German Diabetes Center, Heinrich Heine University Düsseldorf, Universitätsstraße 1, 40225 Düsseldorf, Germany  
e-mail: [lammert@hhu.de](mailto:lammert@hhu.de);  
[alena.welters@med.uni-duesseldorf.de](mailto:alena.welters@med.uni-duesseldorf.de)

## Pathophysiology of Diabetes Mellitus and Metabolic Alterations

### Type 1 Diabetes

T1DM is regarded as an autoimmune disease, in which the insulin-producing  $\beta$ -cells of the pancreatic islets (see chapter “[Overview](#)” under the part “Pancreas”) are destroyed. Various immunologic, environmental, and genetic events lead to the activation of autoreactive CD4<sup>+</sup> and CD8<sup>+</sup> T cells (see chapter “[Overview](#)” under the part “Immune system”) that initiate an inflammatory process, termed insulinitis. This is followed by the activation of B lymphocytes or B cells, which start to produce autoantibodies, and by the activation of the innate immune system. Once immune destruction of the pancreatic  $\beta$  cells has been initiated, several released islet autoantigens trigger activation of new autoreactive T cells and production of islet-specific autoantibodies [1]. The latter can be detected in the serum of pre-symptomatic individuals and can in combination with a genetic analysis predict the onset of type 1 diabetes, especially in first-degree relatives of diabetic patients, and when multiple antibodies are present that persist over time [6]. T1DM clinically manifests when 80–95 % of the  $\beta$  cells are destroyed.

Different genetic loci associate with an increased or decreased risk to develop T1DM, predominantly within genes encoding for human leukocyte antigens (HLA) that present peptides from professional antigen-presenting cells, such as B cells, to T cells (see chapter “[Overview](#)” under the part “Immune system”). Triggering environmental factors include several viral infections (especially with Coxsackie B or congenital rubella virus), childhood nutrition (e.g., early exposure to cow milk or gluten), and childhood vaccination [7] (e.g., against hepatitis B and Haemophilus influenzae type b) that all might introduce peptides with amino acid sequences similar to islet autoantigens to the developing immune system, thus initiating autoimmunity against  $\beta$  cells (a process called molecular mimicry) [8]. Other factors, including low birth weight, also increase the risk to develop T1DM.

### Type 2 Diabetes

A crucial step in the development of T2DM is the decreased biological response to insulin, termed peripheral insulin resistance, which affects different organs, including the liver, skeletal muscle, and white adipose tissue. Particularly, hepatic insulin resistance and a concomitant increase in endogenous glucose production play a key role in the development of hyperglycemia in T2DM patients. In early disease stages, increasing insulin secretion from  $\beta$ -cells compensates for peripheral insulin resistance (hyperinsulinemic phase). However, over time,  $\beta$ -cell dysfunction develops (see below) and insulin secretion declines, ultimately resulting in hyperglycemia (hypoinsulinemic phase).

Obesity and physical inactivity strongly associate with insulin resistance and the incidence of T2DM. If the mass of white adipose tissue, particularly visceral and deep subcutaneous depots, increases, adipocytes mainly secrete factors (adipokines; see chapter “[Overview](#)” under the part “Fat Tissue”) that negatively affect insulin sensitivity,  $\beta$ -cell function, and survival. In addition, immune cells such as monocytes and macrophages infiltrate the adipose tissue contributing to local and systemic inflammation. Altogether, this results in increased levels of proinflammatory cytokines such as tumor necrosis factor  $\alpha$  (TNF $\alpha$ ), interleukin (IL)-6, IL-1 $\beta$ , monocyte chemoattractant protein-1 (MCP-1), and hormones such as leptin [9, 10]. Leptin regulates food intake and glycemia through the activation of leptin receptors expressed by hypothalamic neurons. Hyperleptinemia in obese patients thus suggests central leptin resistance. Importantly, leptin also induces inflammatory responses and activates immune cells to produce proinflammatory cytokines while suppressing the production of anti-inflammatory cytokines [10, 11]. In addition, the release of nonesterified fatty acids (NEFAs) and glycerol from adipocytes is chronically elevated in many obese individuals due to enhanced lipolysis. These fatty acids aggravate insulin resistance, inhibit insulin secretion, and induce  $\beta$ -cell apoptosis, in a process called lipotoxicity (Fig. 1) [12]. Obesity



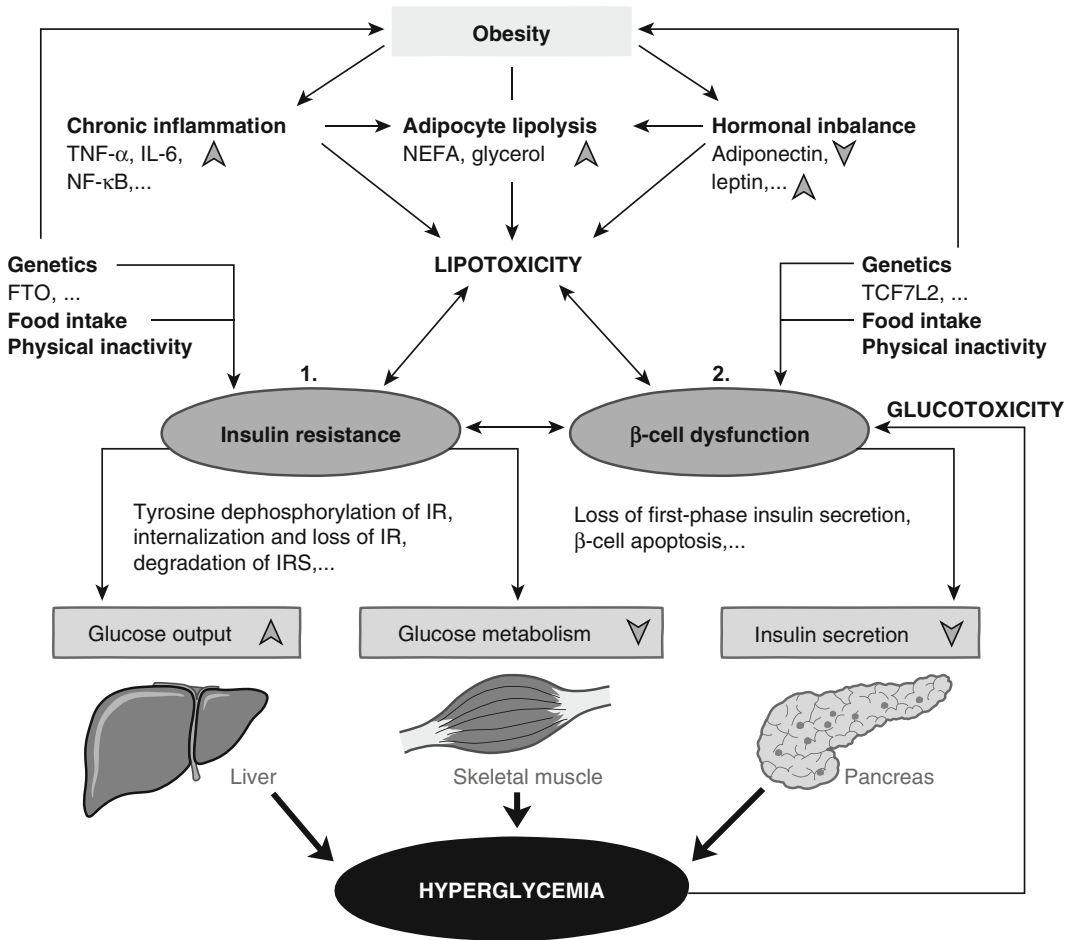

**Fig. 1** Pathogenesis of type 2 diabetes mellitus. Two main pathophysiological features contribute to the manifestation of type 2 diabetes mellitus: insulin resistance (1) and  $\beta$ -cell dysfunction (2). Both insulin resistance and  $\beta$ -cell dysfunction develop in the setting of genetic background and environmental factors. Initially, peripheral insulin resistance (1) can be overcome by an increased insulin secretion. Over time, this compensatory mechanism can fail due to mild but progressive increase in blood

glucose (glucotoxicity) and an inflammatory response of the adipose tissue (lipotoxicity), both leading to  $\beta$ -cell dysfunction (2). Thus, peripheral insulin resistance paves the way for the onset of type 2 diabetes. *TNF $\alpha$*  tumor necrosis factor  $\alpha$ , *IL* interleukin, *NF- $\kappa$ B* nuclear factor- $\kappa$ B, *NEFA* nonesterified fatty acids, *FTO* fat mass and obesity-associated protein, *TCF7L2* transcription factor 7-like 2, *IR* insulin receptor, *IRS* IR substrate

also correlates with a decline in circulating levels of anti-inflammatory adipokines such as adiponectin, secreted frizzled-related protein 5 (SFRP5), visceral adipose tissue-derived serine protease inhibitor (vaspin), and omentin-1 [10]. For instance, adiponectin acts as an insulin sensitizer by suppressing hepatic gluconeogenesis, enhancing glucose uptake in skeletal muscle, and inhibiting lipolysis [12].

As exposure to high glucose concentrations is toxic to  $\beta$ -cells, both lipotoxicity and gluco-

toxicity are suggested to contribute to  $\beta$ -cell dysfunction and death (Fig. 1). There is evidence that glucotoxicity is likely mediated by an increased amount of reactive oxygen species (ROS) following oxidative glucose metabolism in the  $\beta$ -cell [13]. Several genes and mutations are also implicated in the development of T2DM. For example, variants of the gene encoding the fat mass and obesity-associated protein (FTO) associate with obesity and metabolic syndrome (see chapter “Metabolic syndrome”). Moreover,

single nucleotide polymorphisms (SNPs) within the gene locus for the transcription factor 7-like 2 (TCF7L2), also known as transcription factor 4, are linked to an approximately 1.5-fold increased risk to develop T2DM. However, nongenetic features such as a large waist circumference appear to have a better predictive value [14].

In general, obesity, insulin resistance, glucotoxicity, and lipotoxicity develop over several years and ultimately result in a decline of functional  $\beta$ -cell mass to 40–60 % of normal, thus leading to an overt T2DM [15].

## Complications

Hyperglycemia is associated with acute life-threatening complications, such as ketoacidosis or hyperosmolar hyperglycemic state, and with serious long-term complications particularly affecting the cardiovascular system (see chapters “[Atherosclerotic heart disease](#)”, “[Heart failure](#)”, and “[Stroke](#)”). Cardiovascular disease accounts for approximately 70 % of all causes of death in patients with T2DM [16].

Chronic hyperglycemia causes vascular complications in part via an increased formation of advanced glycation end products (AGEs), production of ROS, or activation of the renin-angiotensin-aldosterone system (RAAS, see chapter “[Overview](#)” under the part “[Kidney](#)”) [17, 18]. AGEs are formed by nonenzymatic glycosylation of proteins, lipids, and nucleic acids, which is accelerated in diabetes due to increased blood glucose concentrations. The activation of the receptor for AGE (RAGE) elicits oxidative stress and vascular inflammation, thus leading to endothelial and smooth muscle cell dysfunction [19].

Subsequently, an imbalance in vasoconstriction and vasodilation, failure in the regulation of angiogenesis and blood flow, and changes in platelet function and coagulation contribute to microvascular disease resulting in retinopathy (see chapter “[Overview](#)” under the part “[Eye](#)”), nephropathy (see chapter “[Chronic kidney disease](#)”), neuropathy, and macrovascular disease, such as atherosclerosis, thrombosis, and thromboembolism (see chapters “[Atherosclerotic heart](#)

[disease](#)”, “[Overview](#)” under the part “[Blood vessels](#)”, and “[Stroke](#)”) [20].

---

## Diabetes Treatment and Its Influence on Metabolism

The main goal in the treatment of diabetes is to maintain the blood glucose level within a physiological range, e.g., by decreasing insulin resistance, by activating endogenous insulin secretion, or by exogenous administration of recombinant insulin.

Of note, increasing endogenous insulin secretion requires yet functional  $\beta$  cells.

In T1DM, where the functional  $\beta$ -cell mass is already significantly reduced once symptoms occur, patients immediately require insulin replacement therapy.

Traditionally, exogenous insulin is administered by subcutaneous injection. Today, insulin therapy is individualized and varies regarding insulin preparation (rapid- and short-acting insulin vs. intermediate- and long-acting insulin), application system (pen vs. insulin pump), and regimen (conventional vs. intensified regimen; see below).

To mimic physiological insulin secretion, an intensified regimen is recommended for T1DM that combines the application of a long-acting insulin (e.g., insulin glargine or insulin detemir), mimicking basal insulin secretion, with premeal bolus application of a rapid- or short-acting insulin (e.g., insulin lispro or insulin aspart) adjusted for the amount of carbohydrate intake and current blood glucose level.

By contrast, current treatment guidelines in T2DM recommend a stepwise approach starting with lifestyle changes, such as physical activity and weight reduction, and follow up with drug treatment, typically with metformin (see below and Fig. 2). Initially, most patients can be treated with an oral glucose-lowering drug (see below and Fig. 2). However, over time, due to the progressive nature of the disease, many patients require a combination of two or more antidiabetic drugs (Fig. 2). The benefit of glucose-lowering treatment is judged by the concentration of glycosylated hemoglobin (called HbA1c)

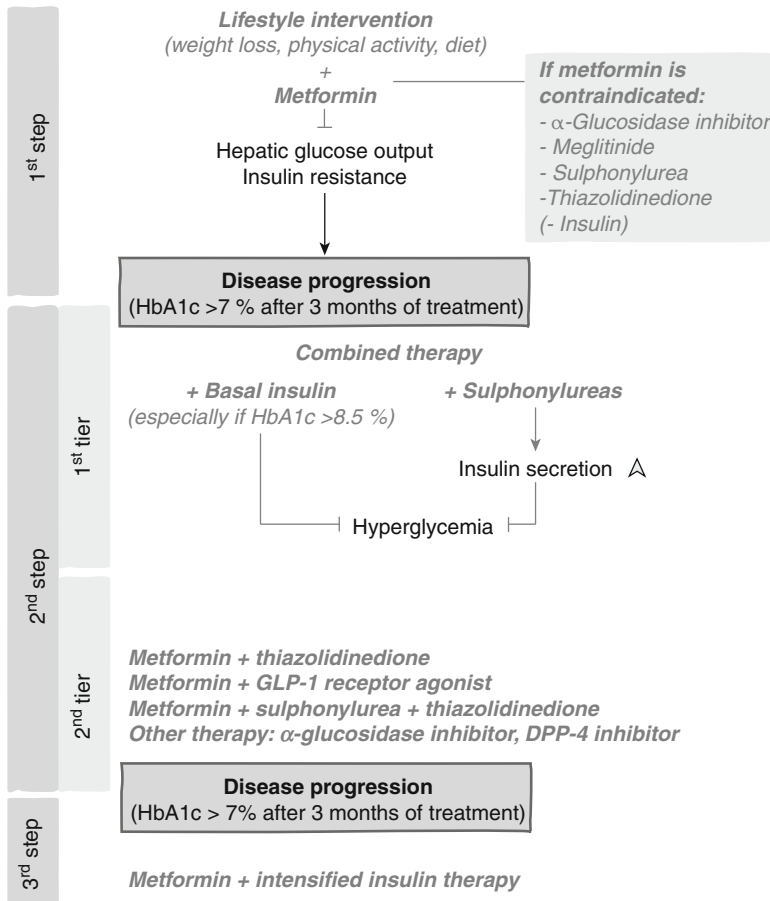

**Fig. 2** Long-term management of hyperglycemia in type 2 diabetes mellitus. Treatment of type 2 diabetes mellitus (T2DM) generally starts with lifestyle intervention and an oral antidiabetic drug, typically metformin (1st step). If glycated hemoglobin (HbA1c) continues to be >7% after 3 months of therapy, treatment is intensified by addition of a second oral antidiabetic drug, typically a sulphonylurea, or basal insulin therapy (2nd step, 1st tier). Importantly, treatment of T2DM is individualized for each patient. Depending on comorbidities and/or contraindications to

certain drugs, some patients might require medications other than metformin or sulphonylureas to achieve glycaemic control (2nd step, 2nd tier). If the disease further progresses (as indicated by HbA1c measurement after 3 months of therapy), a combination of metformin and an intensified insulin therapy is recommended (3rd step) (Adapted from the American Diabetes Association/ European Association for the Study of Diabetes (ADA/ EASD) consensus algorithm [26])

representing a patient’s average blood glucose level over the past 4 months. A level of 7% is often recommended.

To date, there are several glucose-lowering, oral drugs on the market that differ in their modes of action and safety profiles (Fig. 2). These include oral drugs that directly stimulate insulin secretion (sulphonylureas, meglitinides), reduce hepatic glucose output and increase insulin sensitivity (biguanides such as metformin), delay the digestion and absorption of intestinal car-

bohydrates ( $\alpha$ -glucosidase inhibitors), improve insulin action (thiazolidinediones such as pioglitazone), or increase endogenous concentrations of the incretin glucagon-like-peptide-1 (GLP-1, see chapter “Overview” under the part “Pancreas”) by inhibiting the protease dipeptidyl peptidase-4 (DPP-4), which degrades GLP-1 (DPP-4 inhibitors). In addition, homologues or mutated forms of GLP-1 (GLP-1 receptor agonists) can be injected, increasing insulin secretion in response to food intake and promoting  $\beta$ -cell survival.

However, many approved antidiabetic drugs can cause serious adverse effects, such as hypoglycemia (insulin, sulfonylureas, meglitinides), weight gain (insulin, sulfonylureas, meglitinides, thiazolidinediones), gastrointestinal disturbances ( $\alpha$ -glucosidase inhibitors, biguanides), peripheral edema, fractures, and an increased risk for congestive heart failure (see chapter “[Heart failure](#)”) without an associated increase in mortality (pioglitazone), or severe lactic acidosis (biguanides) [21, 22]. Incretin homologues have been shown to induce pancreatitis and possibly pancreatic hyperplasia [23].

## Perspectives

Recently, SGLT-2 inhibitors have been developed to inhibit renal glucose reabsorption, thus leading to increased glucose excretion and reduction of hyperglycemia [24]. Moreover, novel insulin delivery systems are currently tested such as sensor-augmented insulin pumps or fully automated closed-loop systems (also referred to as the “artificial pancreas”) that continuously sense the blood glucose level and automatically deliver insulin [25].

Importantly, none of the current therapies is curative, necessitating lifelong diabetes treatment. Thus, identification of a curative drug taken for a short period of time to prevent  $\beta$ -cell destruction and trigger  $\beta$ -cell regeneration is the long-term goal of current diabetes research. A more detailed understanding of the molecular mechanisms leading to progressive  $\beta$ -cell death and dysfunction in diabetes is therefore required to develop such treatments.

## References

1. Bluestone JA, Herold K, Eisenbarth G (2010) Genetics, pathogenesis and clinical interventions in type 1 diabetes. *Nature* 464:1293–1300
2. WHO/IDF (2006) Definition and diagnosis of diabetes mellitus and intermediate hyperglycemia; Report of a WHO/IDF consultation; ISBN: 978-92-4-159493-6
3. Sherwin R, Jastreboff AM (2012) Year in diabetes 2012: the diabetes tsunami. *J Clin Endocrinol Metab* 97:4293–4301
4. American Diabetes Association (2012) Diagnosis and classification of diabetes mellitus. *Diabetes Care* 35(Suppl 1):S64–S71
5. American Diabetes Association (2004) Gestational diabetes mellitus. *Diabetes Care* 27(Suppl 1):S88–S90
6. Boitard C (2012) Pancreatic islet autoimmunity. *Presse Med* 41:e636–e650
7. Peng H, Hagopian W (2006) Environmental factors in the development of type 1 diabetes. *Rev Endocr Metab Disord* 7:149–162
8. Classen JB, Classen DC (2001) Vaccines and the risk of insulin-dependent diabetes (IDDM): potential mechanism of action. *Med Hypotheses* 57:532–538
9. Kahn SE, Hull RL, Utzschneider KM (2006) Mechanisms linking obesity to insulin resistance and type 2 diabetes. *Nature* 444:840–846
10. Kwon H, Pessin JE (2013) Adipokines mediate inflammation and insulin resistance. *Front Endocrinol* 4:71
11. Coppari R, Bjorbaek C (2012) Leptin revisited: its mechanism of action and potential for treating diabetes. *Nat Rev Drug Discov* 11:692–708
12. Stumvoll M, Goldstein BJ, van Haeften TW (2005) Type 2 diabetes: principles of pathogenesis and therapy. *Lancet* 365:1333–1346
13. Robertson RP, Harmon J, Tran PO, Poitout V (2004) Beta-cell glucose toxicity, lipotoxicity, and chronic oxidative stress in type 2 diabetes. *Diabetes* 53(Suppl 1):S119–S124
14. Siren R, Eriksson JG, Vanhanen H (2012) Waist circumference a good indicator of future risk for type 2 diabetes and cardiovascular disease. *BMC Public Health* 12:631
15. Weir GC, Cavelti-Weder C, Bonner-Weir S (2011) Stem cell approaches for diabetes: towards beta cell replacement. *Genome Med* 3:61
16. Laakso M (1999) Hyperglycemia and cardiovascular disease in type 2 diabetes. *Diabetes* 48:937–942
17. Yamagishi S (2011) Role of advanced glycation end products (AGEs) and receptor for AGEs (RAGE) in vascular damage in diabetes. *Exp Gerontol* 46:217–224
18. Furukawa M, Gohda T, Tanimoto M, Tomino Y (2013) Pathogenesis and novel treatment from the mouse model of type 2 diabetic nephropathy. *Scientific World Journal* 2013:928197
19. Sho-ichi Y (2010) Role of advanced glycation end products (AGEs) and receptor for AGEs (RAGE) in vascular damage in diabetes. *Exp Gerontol* 46:217–224
20. Costa PZ, Soares R (2013) Neovascularization in diabetes and its complications. Unraveling the angiogenic paradox. *Life sci* 92:1037–1045
21. Lincoff AM, Wolski K, Nicholls SJ, Nissen SE (2007) Pioglitazone and risk of cardiovascular events in patients with type 2 diabetes mellitus: a meta-analysis of randomized trials. *JAMA* 298:1180–1188
22. Black C et al (2007) Meglitinide analogues for type 2 diabetes mellitus. *Cochrane Database Syst Rev* 18;(2):CD004654

23. Butler AE et al (2013) Marked expansion of exocrine and endocrine pancreas with incretin therapy in humans with increased exocrine pancreas dysplasia and the potential for glucagon-producing neuroendocrine tumors. *Diabetes* 62:2595–2604
24. Riser Taylor S, Harris KB (2013) The clinical efficacy and safety of sodium glucose cotransporter-2 inhibitors in adults with type 2 diabetes mellitus. *Pharmacotherapy* 33:984–999
25. Yaturu S (2013) Insulin therapies: current and future trends at dawn. *World J Diab* 4:1–7
26. Nathan DM et al (2009) Medical management of hyperglycemia in type 2 diabetes: a consensus algorithm for the initiation and adjustment of therapy: a consensus statement of the American Diabetes Association and the European Association for the Study of Diabetes. *Diabetes Care* 32:193–203

---

## **Part VII**

### **Liver**

---

# Overview

Dieter Häussinger

---

## Anatomy and Physiology of the Liver

The liver is one of the metabolically most active and versatile organs. It has a dual blood supply: about 25 % comes via the hepatic artery and about 75 % is delivered via the portal vein, which drains blood coming from the intestine. Accordingly, it is the first organ to get in contact with intestinally absorbed nutrients, ingested toxins, and products from intestinal microorganisms. Thus, major tasks of the liver are (1) to process and store nutrients contained in the intestinal or splanchnic blood and to guarantee an adequate nutrient supply for other organs during both the absorptive and postabsorptive state; (2) to detoxify and excrete xeno- and endobiotics into the bile; (3) to participate in pathogen defense and immune functions and to trigger acute phase responses in inflammation; and (4) to fulfill other homeostatic functions such as maintenance of acid-base and glucose homeostasis (see chapter “[Diabetes mellitus](#)”), synthesis of most plasma proteins (see chapter “[Overview](#)” under the part “[Blood](#)”), triglyceride and cholesterol metabolism and transport (see chapter “[Hyperlipidemia](#)”), and hormone processing and secretion. Furthermore, bile acids

(BAs) are synthesized in the liver, which aid in triglyceride digestion in the intestine (see chapter “[Overview](#)” under the part “[Gastrointestinal tract](#)”) and are increasingly recognized as important signaling molecules and coordinators of interorgan metabolism.

Seventy percent of the hepatic cell mass are made up by liver parenchymal cells (PCs, also called hepatocytes), whereas the remainder comprises different non-parenchymal cell types. These include the fenestrated sinusoidal endothelial cells, Kupffer cells as liver-resident macrophages, vitamin A storing hepatic stellate cells, large granular lymphocytes called pit cells, cholangiocytes, and progenitor cells (called “oval cells” in rodents). The latter are located at the canals of Hering (intrahepatic bile ductules) and can differentiate into PCs or cholangiocytes. Hepatic stellate cells are mesenchymal stem cells and are located in the space of Disse (Fig. 1), which has characteristics of a stem cell niche [1]. Following liver injury, liver regeneration is primarily achieved by division of preexisting PCs, but under conditions of impaired replication ability of PCs, stem cell-based liver regeneration comes into play, which involves oval cells and hepatic stellate cells [2].

The various cell types in the liver are embedded in the liver acinus into a structural-functional organization with complex intra- and intercellular communication. The acinus represents the functional unit of the liver and extends from the terminal portal venule along the sinusoid to the terminal hepatic venule (Fig. 1). Along the acinus,

---

D. Häussinger  
Clinic for Gastroenterology, Hepatology and  
Infectious Diseases, University Hospital Düsseldorf,  
Heinrich Heine University Düsseldorf,  
Moorenstraße 5, 40225 Düsseldorf, Germany  
e-mail: [haeussin@uni-duesseldorf.de](mailto:haeussin@uni-duesseldorf.de)

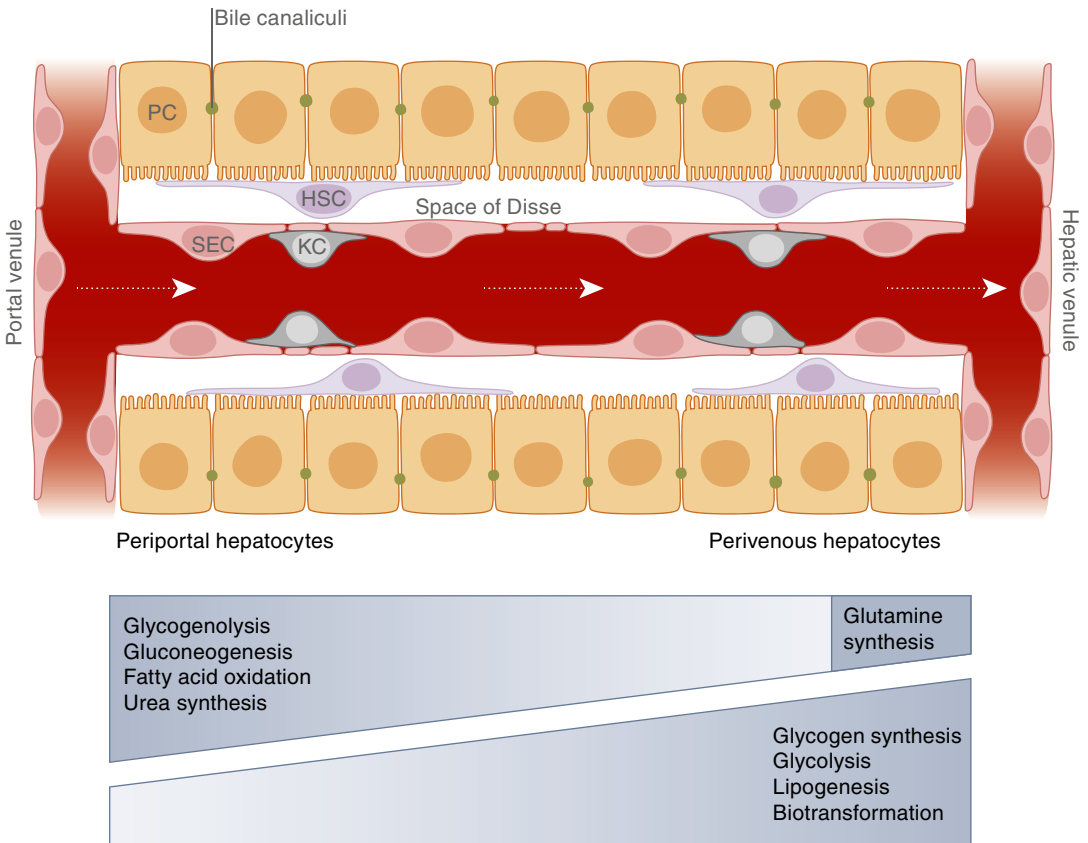

**Fig. 1** Acinar organization and metabolic zonation. The liver acinus is the functional unit of the liver and extends from the terminal portal venule to terminal hepatic venule. Schematic presentation of the cells constituting the acinus, i.e., parenchymal cells (PCs, also called hepatocytes), liver macrophages (Kupffer cells, KCs), sinusoidal

endothelial cells (SECs), and hepatic stellate cells (HSCs) located in the space of Disse. PCs are polar cells and adjacent PCs form the bile canaliculus with their apical membrane. Along the acinus, metabolic pathways show gradients or are heterogeneously distributed (“metabolic zonation”)

the portal-venous blood, which mixes with blood from the hepatic artery in the inflow segment of the acinus, passes 20–30 PCs. These are morphologically very similar but differ in their enzyme and transporter equipment (the so-called PC heterogeneity or metabolic zonation) [3]. Metabolite, hormone, and oxygen gradients but also signals from neighboring cells are thought to be responsible for this metabolic zonation. Periportal PCs, i.e., those located at the sinusoidal inflow, are primarily engaged in gluconeogenesis, fatty acid oxidation, and urea synthesis, whereas glycolysis, lipogenesis, and biotransformation predominate in perivenous PCs (located at the sinusoidal outflow). Glutamine synthetase is exclusively

localized in a small perivenous PC subpopulation, the so-called perivenous scavenger cells, which eliminate ammonia, eicosanoids, and other signaling molecules with high affinity before the sinusoidal blood enters the systemic circulation.

## Liver-Specific Metabolic Pathways and Processes

### Plasma Protein Synthesis

Except for immunoglobulins, most circulating plasma proteins are synthesized in the liver. These include albumin, which is responsible for transport



of some lipophilic substances (in the bloodstream) and regulation of oncotic pressure, and acute phase proteins, which are synthesized and secreted by PCs in response to cytokines such as tumor necrosis factor  $\alpha$  (TNF $\alpha$ ), interleukin-1, and interleukin-6, which are produced by macrophages including Kupffer cells, endothelial cells, and fibroblasts at sites of injury. The plasma concentrations of acute phase proteins (such as C-reactive protein) can increase within hours after a local inflammatory reaction up to several hundredfold and apart from opsonization (see chapter “[Overview](#)” under the part “Immune system”); their role mainly resides in a local restriction of inflammatory processes.

## Nutrient Metabolism

The liver is the central organ of glucose homeostasis and acts as a “glucostat.” In the absorptive phase, when plasma insulin levels increase, the liver synthesizes and stores glycogen from gluconeogenic precursors in periportal PCs and from absorbed glucose in perivenous PCs, whereas glucose becomes mobilized from glycogen in the postabsorptive state, when insulin levels are low and glucagon levels are high (see chapters “[Overview](#)” under the part “Pancreas” and “[Diabetes mellitus](#)”). After exhaustion of glycogen stores, gluconeogenesis mainly from glucogenic amino acids, glycerol, and lactate is stimulated through induction of enzymes of amino acid metabolism, gluconeogenesis, and the urea cycle, whereas glycolytic enzymes become repressed in perivenous PCs. The shift from net glucose consumption to net glucose output in the postabsorptive state is therefore accomplished by increasing the flux through the periportal gluconeogenic pathway and a simultaneous decrease of glycolytic flux in perivenous PCs [3]. The liver is also a major organ for synthesis of triglycerides, cholesterol, and sphingolipids and secretes very low-density lipoproteins (see chapter “[Hyperlipidemia](#)”). In the postabsorptive state, fatty acid oxidation provides energy for the liver; ketogenesis and ketone body release from the liver can provide energy for other organs, such as the brain (see chapter “[Overview](#)” under the part “Brain”).

## Urea Synthesis and Acid-base Homeostasis

One liver-specific pathway is urea synthesis [4] from bicarbonate ( $\text{HCO}_3^-$ ) and ammonium ( $\text{NH}_4^+$ ), which are generated in almost stoichiometric amounts during complete amino acid oxidation. Urea synthesis can be viewed as an energy-driven neutralization of the strong base  $\text{HCO}_3^-$  by the weak acid  $\text{NH}_4^+$ :

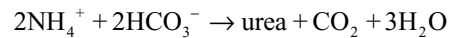

Thus, the role of urea synthesis resides not only in the removal of potentially toxic ammonium ions but also in the removal of bicarbonate. Through a pH-regulated partitioning of hepatic ammonium disposal via either bicarbonate-consuming urea synthesis or via glutamine synthesis (from glutamate and ammonium), the liver can adjust the rate of bicarbonate disposal to the needs of systemic acid-base homeostasis. The structural-functional organization of urea and glutamine synthesis in the liver acinus allows for this role: in periportal PCs, ammonium is disposed of via urea synthesis, whereas downstream perivenous scavenger cells maintain ammonia homeostasis by high-affinity disposal via glutamine synthesis. In the kidney, ammonia is then liberated from glutamine by renal glutaminase and excreted into the urine. Glutamine uptake, glutaminase, and carbonic anhydrase V in periportal PCs are major sensitively acid-base regulated steps, which adjust flux through the  $\text{HCO}_3^-$ -disposing urea cycle. Selective destruction of perivenous scavenger cells or specific knockdown of glutamine synthetase in these cells triggers hyperammonemia.

## Bile Formation and Bile Acid Secretion

Another liver-specific pathway is biliary excretion of endo- and xenobiotics and bile formation [5]. PCs are polar cells, in which the basolateral (sinusoidal) membrane faces the bloodstream, whereas the apical (canalicular) membrane of

two adjacent PCs forms the bile canaliculus, which is sealed by tight junctions. Bile formation is an osmotic process, which is driven by the coordinated action of transport systems in the sinusoidal and canalicular membranes of the PC and subsequent water flow. PCs metabolize cholesterol to lipid-soluble, unconjugated BAs, which are later conjugated to become water-soluble. At the sinusoidal membrane, conjugated BAs are taken up by the  $\text{Na}^+$ -taurocholate cotransporting protein (NTCP), whereas sinusoidal uptake of unconjugated BAs, bilirubin (a catabolite of heme), and other anions is accomplished by the organic anion transporting protein (OATP) family (Fig. 2). Canalicular secretion is achieved by transport ATPases, such as the bile salt export pump (BSEP), and the bilirubin-transporting multidrug resistance-related protein (MRP2, Fig. 2).

In addition to bilirubin and BAs, cholesterol, phospholipids, and other substances are also secreted into the canaliculi via specific transporters, such as the aminophospholipid transporter FIC1 (from familial intrahepatic cholestasis), the cholesterol transporter ABCG5/G8 (ATP-binding cassette G5/G8), and the multidrug resistance protein 1 and 3, the latter of which acts as a flip-pase and transports phospholipids from the inner to the outer leaflet of the canalicular membrane (Fig. 2).

The BSEP and MRP2 are regulated at the level of gene expression but also on short-term time scale by dynamic insertion/retrieval of the transporters into/from the canalicular membrane. High BA concentration (overload) in PCs activates the nuclear transcription factor farnesoid X receptor (FXR), which upregulates the BSEP and MRP2 expression and downregulates expression of NTCP and cholesterol-7 $\alpha$ -hydroxylase, a rate-controlling step of BA synthesis. In cholestasis, a condition of impaired bile formation, compensatory BA efflux pathways via MRP3 and 4 located at the sinusoidal part of the PC membrane become activated (Fig. 2). These responses protect PCs against intracellular BA accumulation, which is toxic and can lead to PC apoptosis [5].

In addition to FXR, bile acids can activate TGR5, a G protein-coupled BA receptor in the plasma membrane of cholangiocytes, Kupffer cells, sinusoidal endothelial cells, and other cell types. This triggers cAMP formation, which

protects sinusoidal endothelial cells and cholangiocytes against BA-induced apoptosis, increases bile flow through stimulation of  $\text{Cl}^-$  secretion by cholangiocytes, and ameliorates cytokine formation by Kupffer cells.

A small fraction of BAs is reabsorbed from the bile duct by the apical sodium-dependent bile salt transporter (ASBT), excreted into the blood via the organic solute and steroid transporter  $\alpha\beta$  (OST $\alpha\beta$ ), and recirculated to the liver, a process called cholehepatic shunting (Fig. 2).

## Detoxification

Detoxification of endo- and xenobiotics involves biotransformation of these compounds. Such reactions convert lipophilic compounds into polar, water-soluble metabolites. In a first step (biotransformation phase I), such compounds become hydroxylated or N- or O-dealkylated by cytochrome P450 enzymes and undergo oxidative deamination or hydrolysis. Such reactions introduce or expose reactive groups, which are used in phase II of biotransformation for conjugation reactions, leading to the formation of hydrophilic compounds, which can be excreted into the bile or urine. Such conjugation reactions include glucuronidation, sulfation, or coupling to glutathione or amino acids such as glycine, taurine, or glutamine. Phase III of biotransformation describes the excretion of such conjugates into bile or blood via canalicular transporters (e.g., MRP2) or sinusoidal OATPs, respectively.

Phase I–III enzyme activities can be induced by endo- and xenobiotics after their binding to nuclear receptors, such as constitutive androstane receptor or the pregnane X receptor (also called steroid and xenobiotic-sensing nuclear receptor). After heterodimerization with the retinoid X receptor, these act as transcription factors inducing a variety of genes involved in biotransformation, such as cytochrome P450 family 3A (CYP3A), glutathione-S-transferases, or OATP2. Aromatic hydrocarbons are sensed by the aryl hydrocarbon receptor (AHR), which together with the aryl hydrocarbon receptor nuclear translocator (ARNT) acts as a ligand-activated transcription factor, which regulates the expression of phase I and II enzyme activities. Biotransformation reactions can also give rise to toxic products. One

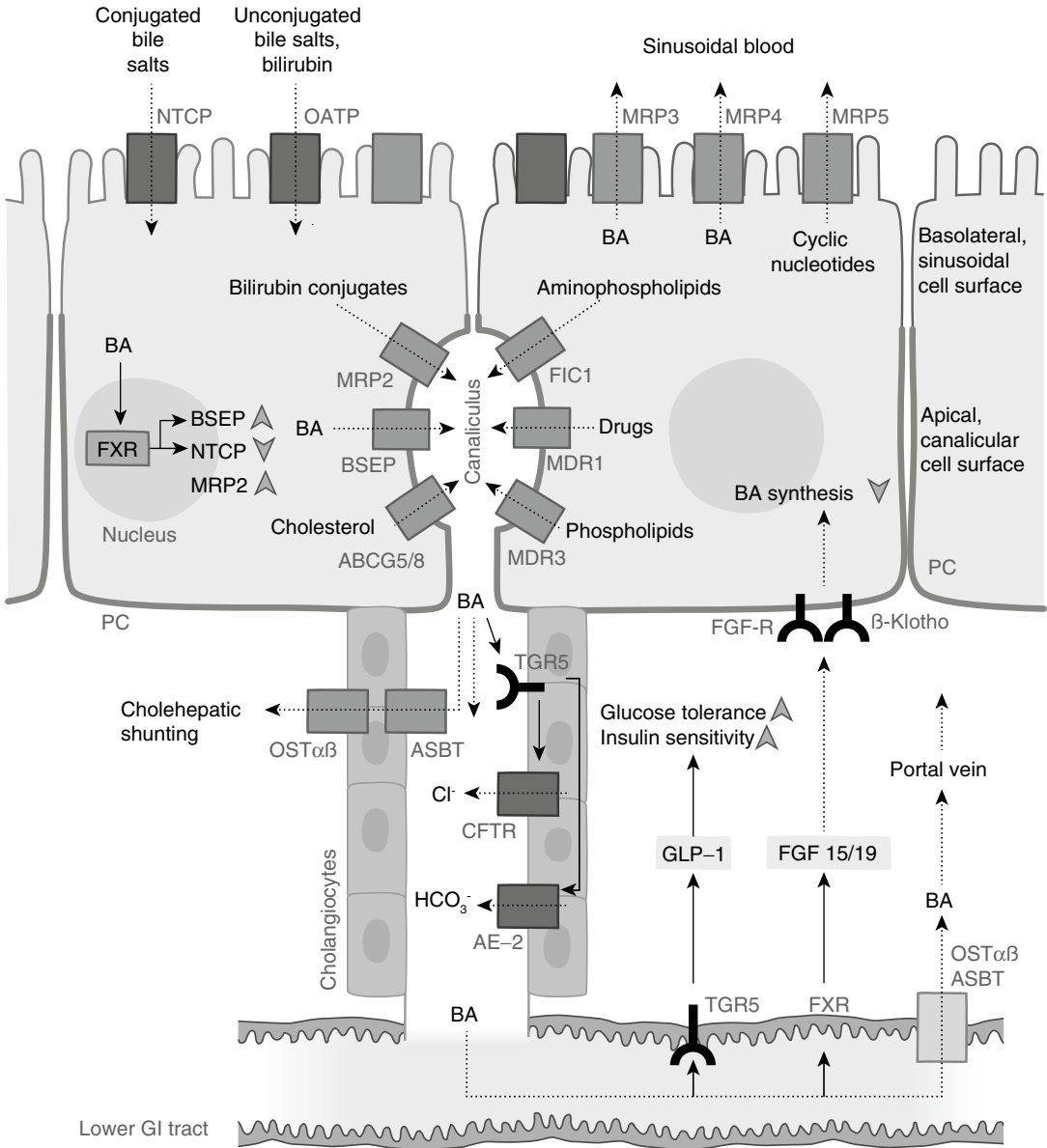

**Fig. 2** Schematic representation of hepatobiliary transport systems, bile formation, and bile acid signaling. Conjugated and unconjugated bile acids (BAs) are taken up from the blood into the liver parenchymal cells (PCs) via Na<sup>+</sup>-taurocholate cotransporting protein (NTCP) and organic anion transport protein (OATP), respectively. High levels of BAs in the PC can activate the farnesoid X receptor (FXR) to reduce the BA load (by reducing uptake and increasing excretion, left PC). Under conditions of cholestasis, BAs can be exported into the blood by means of multidrug resistance-associated proteins 3–5 (MRP3–5, right PC). Both mechanisms help to prevent BA-induced liver damage. Biliary excretion of various substances is accomplished by specific transport ATPases in the canalicular, apical membrane of the PC. In the bile duct, a small fraction of BAs is reabsorbed by the apical sodium-dependent bile salt transporter ASBT, excreted into the blood via the organic solute and steroid transporter (OST) α and β and recirculated to the

liver (“cholehepatic shunting”). In the bile duct, cholangiocytes sense the bile acid concentration via the G protein-coupled bile acid receptor TGR5 causing an increase in chloride excretion into the lumen to increase bile flow. In the intestine, BAs can activate their receptors FXR and TGR5 in order to signal back to the liver and to secrete glucagon-like peptide-1 (GLP-1), respectively. GLP-1 increases glucose tolerance. The signal to the liver downstream of FXR is relayed via fibroblast growth factor (FGF) 15/19. This activates its receptor (FGF-R/β-Klotho) on PCs to repress further BA synthesis. Additionally, BAs are also reabsorbed in the terminal ileum and transported back to the liver (“enterohepatic circulation of BAs”) BSEP bile salt export protein, ABCG5/G8 ATP-binding cassette G5/G8 cholesterol transporter, MDR multidrug resistance protein, FIC1 familial intrahepatic cholestasis aminophospholipid transporter, CFTR cystic fibrosis transmembrane conductance regulator, AE-2 anion exchanger 2

example is the formation of genotoxic derivatives of benzopyrene. Another example is paracetamol (acetaminophen) toxicity. This drug is partly converted to a highly toxic quinone derivative, which is immediately detoxified by S-conjugation with glutathione. However, after depletion of glutathione stores, this highly reactive intermediate forms protein adducts, which can produce acute liver necrosis.

---

### Inside-Out: Metabolites of the Liver Affecting Other Tissues

BAs also serve as signaling molecules in other tissues because the bile acid receptors FXR and TGR5 are also found in extrahepatic tissues (Fig. 2). TGR5 activation in enteroendocrine intestinal cells triggers release of glucagon-like peptide-1 (GLP-1) from the ileal L cells, thereby stimulating insulin secretion from  $\beta$  cells (see chapter “[Overview](#)” under the part “Pancreas”) delaying gastric emptying and improving insulin sensitivity, thus increasing glucose tolerance (see chapter “[Diabetes mellitus](#)”) [6]. Activation of FXR in the ileum by BAs triggers formation and release of fibroblast growth factor 15/19, which returns to the liver and activates the fibroblast growth factor receptor/ $\beta$ -Klotho complex to down-regulate hepatic de novo bile acid synthesis [7] and to protect the liver during cholestasis [8] (Fig. 2).

Another example for inside-out signaling is the hepatorenal reflex, which is activated by amino acids most likely through induction of PC swelling and an increase of the sinusoidal blood pressure and which triggers a decrease of glomerular filtration rate (GFR) in the kidney (see chapter “[Overview](#)” under the part “Kidney”) via the afferent vagal nerves and sympathetic efferent nerves [9]. Renal water retention triggered by this reflex may counteract splanchnic blood pooling in the absorptive state. The latter describes the circumstance that after a rich meal, a large volume of blood is diverted to the intestine to facilitate digestion and absorption, resulting in postprandial hypotension. Thus, the hepatorenal reflex contributes to maintain sufficient blood pressure to perfuse vital organs, such as the brain.

Failure of the liver to eliminate  $\text{NH}_4^+$ , which arises during intestinal and hepatic metabolism, can lead to hyperammonemia and ammonia toxicity in the brain (hepatic encephalopathy; see chapter “[Cirrhosis](#)”), which is characterized by a low-grade cerebral edema and an oxidative/nitrosative stress response [10].

---

### Outside-In: Metabolites of Other Tissues Affecting the Liver

There are several ways how metabolites from other tissues can affect liver function. These include hormones and cytokines released from extrahepatic sites. For example, insulin from pancreatic  $\beta$  cells (see chapter “[Overview](#)” under the part “Pancreas”) binds to insulin receptors on PCs in the postabsorptive state and increases nutrient anabolism, such as glycogen synthesis. In addition, nutrients and toxins directly affect liver function through alterations of PC hydration. PC hydration is dynamic and is controlled by a variety of transport systems in the plasma membrane of PCs, which can create or dissipate osmotic gradients. For example, an increased amino acid load to the liver leads to an osmotic water shift into the PC due to cumulative amino acid uptake driven by the transmembrane sodium gradient. This increase of PC volume represents an independent signal regulating liver function. PC swelling increases bile flow (choleresis), inhibits protein and glycogen breakdown, stimulates protein and glycogen synthesis, and acts as an antiapoptotic and proliferative signal. Opposite responses are triggered by PC shrinkage. Control of liver cell functions by fluctuations of PC hydration or PC volume is mediated by osmosensing and osmosignaling pathways [11]. Integrins were identified as important osmosensors in response to PC swelling, activating osmosignaling pathways [12]. Conversely, cell shrinkage is sensed by an increased concentration of intracellular chloride and involves endosomal acidification, ceramide formation, activation of protein kinase  $\text{C}\zeta$  and NADPH oxidase with subsequent formation of reactive oxygen species and further signaling events.

## Final Remarks

The liver plays a major role in intermediary metabolism, maintenance of homeostatic functions, immune responses, and endo- and xenobiotics excretion into bile. These functions are impaired in a variety of diseases, such as hepatitis or cirrhosis (see chapter “[Cirrhosis](#)”).

For more in-depth surveys on liver function, the reader is referred to textbooks of hepatology [13, 14].

## References

1. Kordes C, Häussinger D (2013) Hepatic stem cell niches. *J Clin Invest* 123:1874–1880
2. Häussinger D (2011) *Liver regeneration*, 1st edn. DeGruyter, Berlin/Boston
3. Jungermann K, Katz N (1989) Functional specialization of different hepatocyte populations. *Physiol Rev* 69:708–764
4. Häussinger D (2007) Ammonia, urea production and pH regulation. In: Benhamou JP, Rizetto M, Rodes J, Blei A, Reichen J (eds) *Textbook of hepatology: from basic science to clinical practice*. Wiley-Blackwell, Oxford, pp 181–190
5. Häussinger D, Keitel V, Kubitz R (eds) (2012) *Hepatobiliary transport in health and disease*. DeGruyter, Boston/Berlin
6. Thomas C, Gioiello A, Noriega I, Strehle A, Oury J, Rizzo G, Macchiarulo A, Yamamoto H, Matakı C, Pruzanski M, Pellicciari R, Auwerx J, Schoonjans K (2009) TGR5-mediated bile acid sensing controls glucose homeostasis. *Cell Metab* 10:167–177
7. Inagaki T, Choi M, Moschetta A, Peng L, Cummins CL, McDonald JG, Luo G, Jones SA, Goodwin B, Richardson JA, Gerard RD, Repa JJ, Mangelsdorf DJ, Kliewer SA (2005) Fibroblast growth factor 15 functions as an enterohepatic signal to regulate bile acid homeostasis. *Cell Metab* 2:217–225
8. Modica S, Petruzzelli M, Bellafante E, Murzilli S, Salvatore L, Celli N, Di Tullio G, Palasciano G, Moustafa T, Halilbasic E, Trauner M, Moschetta A (2012) Selective activation of nuclear bile acid receptor FXR in the intestine protects mice against cholestasis. *Gastroenterology* 142:355–365
9. Lang F, Tschernko E, Schulze E, Ottl I, Ritter M, Völkl H, Hallbrucker C, Häussinger D (1991) Hepatorenal reflex regulating kidney function. *Hepatology* 14:590–594
10. Häussinger D, Görg B (2010) Interaction of oxidative stress, astrocyte swelling and cerebral ammonia toxicity. *Curr Opin Clin Nutr Metab Care* 13: 87–92
11. Häussinger D, Sies H (eds) (2007) *Osmosensing and osmosignaling*. *Methods enzymology*, vol 428. Academic Press: San Diego/London
12. Häussinger D, Reinehr R (2011) Osmotic regulation of bile acid transport, apoptosis and proliferation in rat liver. *Cell Physiol Biochem* 28: 1089–1098
13. Rodes J, Benhamou JP, Blei A, Reichen J, Rizetto M (eds) (2007) *Textbook of hepatology*. Wiley-Blackwell, Oxford
14. Arias I (ed) (2009) *The liver: biology and pathobiology*. Wiley-Blackwell, New York

---

# Cirrhosis

Matteo Rosselli and Massimo Pinzani

---

## Introduction to Cirrhosis

Cirrhosis is the consequence of chronic liver disease. When the cause of liver damage is not removed, a chronic inflammatory reaction develops, which is typically accompanied by the accumulation of fibrillar extracellular matrix, nodular regeneration [1], neoangiogenesis, and the establishment of portal hypertension (PH), i.e., high blood pressure in the portal vein, its branches, and tributaries. While PH increases, the hemodynamic derangement extends beyond the splanchnic circulation due to a net increase in circulating vasodilating molecules. This increase is secondary to a systemic and sustained inflammatory reaction and leads to hyperdynamic circulation. The latter is characterized by an increased heart rate and cardiac output as well as a decreased systemic vascular resistance with low arterial blood pressure. Inflammation, altered hemodynamics, and tissue perfusion, together with parenchymal extinction, are also accompanied by a profound metabolic derangement that characterizes cirrhosis in its more advanced stages.

---

M. Rosselli • M. Pinzani (✉)  
Institute for Liver and Digestive Health,  
Division of Medicine, University College London,  
Royal Free Hospital UP3,  
NW3 2QG London, UK  
e-mail: [matteorosselli@gmail.com](mailto:matteorosselli@gmail.com);  
[m.pinzani@ucl.ac.uk](mailto:m.pinzani@ucl.ac.uk)

---

## Pathophysiology of Cirrhosis and Metabolic Alterations

### Portal Hypertension

PH is the hemodynamic consequence (and hallmark) of liver cirrhosis. It is initially caused by two main pathophysiological events. First, collagen deposition and nodular regeneration increase intrahepatic vascular resistance by mechanically compressing vessels. Second, a dysregulation of intrahepatic vasoactive molecules dynamically increases the contraction of hepatic myofibroblasts around the sinusoids, thus increasing the portal blood pressure.

PH is defined by a hepatic venous pressure gradient (HVPG) above 5 mmHg. HVPG is the difference between pressure in the portal vein and the intra-abdominal portion of the inferior vena cava. Under normal conditions, substances absorbed by the intestine follow the enterohepatic circulation, flowing through the portal venous system to be processed by the liver. In cirrhosis, once PH increases beyond 10 mmHg, low-resistance vascular sites are used to create alternative circulatory pathways [2] (e.g., gastroesophageal varices, paraumbilical vein, retroperitoneal venous collaterals, splenorenal shunts) allowing a bypass of the “obstructed” liver. As a consequence, there is a reduced hepatic clearance of gut-derived vasodilating agents, such as endogenous gastrointestinal hormones (glucagon, vasoactive intestinal peptide, calcitonin gene-related peptide) and intestinal bacterial products [3].



In cirrhosis, intestinal transit time is prolonged and the intestinal mucosa is often edematous due to low oncotic pressure (as a consequence of hypoalbuminemia) and increased portal pressure. In addition, biliary secretion and gut luminal biliary content are reduced, so that bile acids no longer exert their antimicrobial effects or contribute to the integrity of intestinal mucosa to a sufficient extent (see chapter “[Overview](#)” under the part “[Liver](#)”) [4]. This can lead to bacterial overgrowth and translocation [5]. The presence of bacterial products in the systemic circulation further activates the immune system, increasing the inflammatory response and leading to a functional immune paralysis that characterizes the typical susceptibility of cirrhotic patients to infections [6]. More specifically, endotoxins (such as lipopolysaccharides, see chapter “[Fever](#)”) activate inflammatory cells, which release cytokines (such as tumor necrosis factor  $\alpha$ , interleukins 1 and 6) and express specific enzymes such as inducible nitric oxide synthase (iNOS) and heme oxygenase (HO) that produce high levels of nitric oxide and carbon monoxide, respectively [7]. Both of these molecules stimulate soluble guanylate cyclase. The resultant cGMP then activates protein kinase G and lowers intracellular  $\text{Ca}^{2+}$  levels in smooth muscle cells (SMCs) thus causing vasodilation. Consequently, the portal pressure increases, whereas the systemic blood pressure decreases (see chapter “[Overview](#)” under the part “[Blood vessels](#)”).

As a compensatory response, the adrenergic system and the renin-angiotensin-aldosterone system (RAAS) are activated (see chapter “[Overview](#)” under the part “[Kidney](#)”). However, despite high levels of catecholamines and other vasoconstrictors such as angiotensin II, the splanchnic and systemic vasodilation persist due to a vascular hyporesponse to the vasoconstrictors. Because of increased sodium and water retention (initially driven by RAAS activity), fluid volume is overall increased but inappropriately distributed and pooled in the splanchnic compartment, in the interstitium, and eventually in the peritoneal space (ascites), thus leading to relative hypovolemia (i.e., decrease in blood plasma volume) [8] (Fig. 1). In response, vaso-

pressin (also called antidiuretic hormone, ADH) is secreted with consequent free water reabsorption, further fluid overload, and dilutional hyponatremia that characterizes cirrhosis in its more advanced stages [9]. Moreover, the low vascular resistances, fluid overload, and high cardiac output characterize the hyperdynamic circulatory syndrome of cirrhosis. Hyperdynamic circulation is sustained by the persistent liver-gut inflammatory interactions, hyperactivation of neurohormonal systems, and reduced renal perfusion. The overall effect is a further increase in portal inflow and portal hypertension, which maintains the vicious cycle [10].

### Reduced Parenchymal Metabolic Function

The progressive decline of functional liver parenchyma is accompanied by reduced albumin synthesis. Hypoalbuminemia leads to low colloid-osmotic pressure and extravasation of fluid in the extravascular spaces or interstitium. Transport of endogenous (unconjugated bilirubin, transferrin, apoproteins, lipid-soluble hormones) and exogenous molecules (e.g., antibiotics, diuretics, NSAIDs) in the blood is also impaired. Moreover, albumin is the main extracellular source of reduced sulfhydryl groups, and therefore, hypoalbuminemia is accompanied by increased oxidative stress and inflammation [11]. In cirrhosis, the lipid profile is often abnormal due to low synthesis of apoproteins and cholesterol (see chapter “[Hyperlipidemia](#)”) [12].

Hepatocytes are responsible for the first hydroxylation of inactive cholecalciferol to calcidiol (see chapters “[Overview](#)” under the part “[Teeth and bones](#)” and “[Osteoporosis](#)”). During cirrhosis, this step is impaired and vitamin D synthesis is reduced together with a low production of vitamin D-binding protein [13].

Moreover, in severe forms of cholestatic liver disease (i.e., when bile cannot flow from the liver to the duodenum), e.g., as a result of primary biliary cirrhosis (i.e., an autoimmune disease accompanied by a progressive destruction of the small bile ducts), vitamin D absorption is also impaired

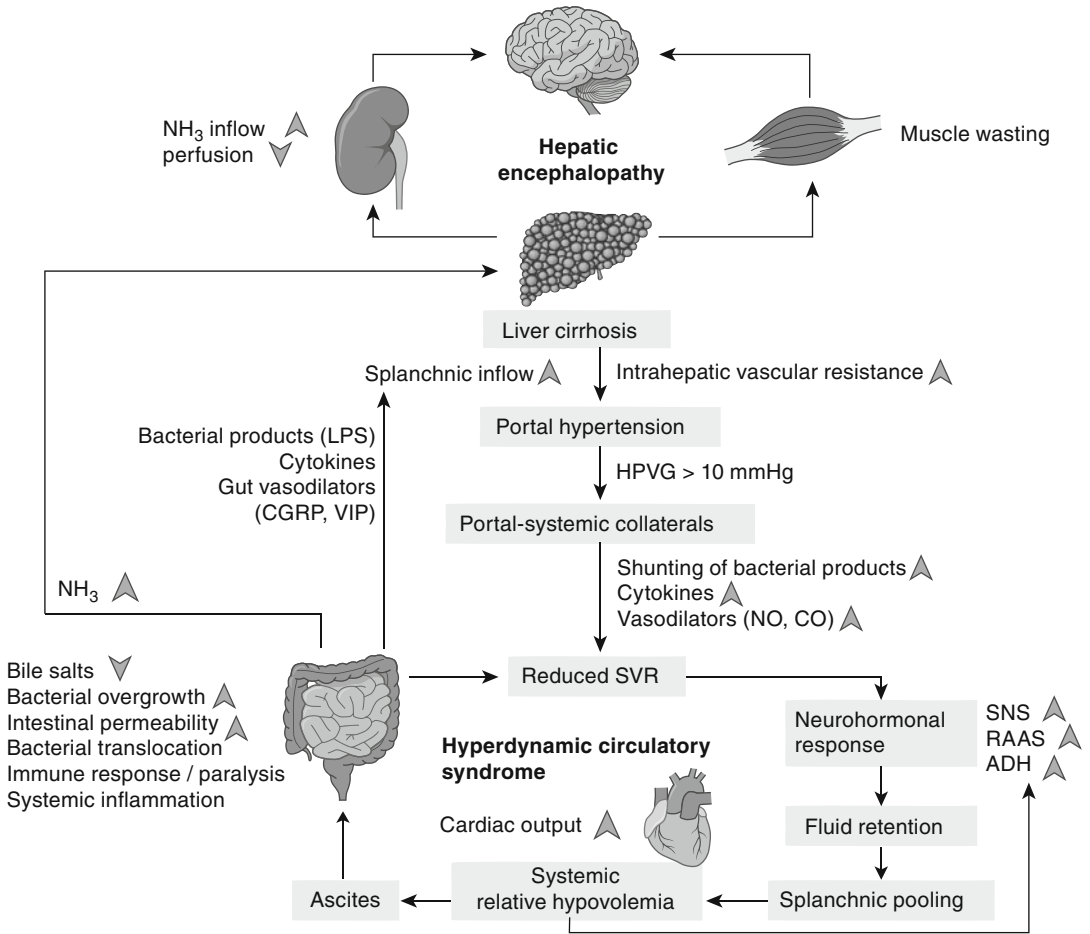

**Fig. 1** Pathophysiology of cirrhosis and associated complications. Increased splanchnic inflow and hepatic vascular resistance in cirrhosis lead to portal hypertension. When the hepatic venous pressure gradient (HVPG) rises above 10 mmHg, portal-systemic collaterals reroute inflammatory cytokines, vasodilators, and gut-derived bacterial products to the systemic circulation. Systemic inflammation leads to vasodilation and reduced systemic vascular resistance (SVR) triggering a neurohormonal response. Retained fluid pools in the splanchnic compartment causing relative hypovolemia throughout the body maintaining the vicious cycle. Ascites develops, aggravat-

ing bacterial translocation and therefore systemic inflammation. Intestinal bacterial overgrowth and reduced transit time increase gut ammonia (NH<sub>3</sub>) production that is not appropriately metabolized by the liver, skeletal muscle, and kidney. Toxic plasma concentrations of NH<sub>3</sub> can then cross the blood-brain barrier causing hepatic encephalopathy. NO nitric oxide, CO carbon monoxide, SNS sympathetic nervous system, RAAS renin-aldosterone-angiotensin system, ADH antidiuretic hormone (vasopressin), LPS lipopolysaccharide, CGRP calcitonin gene-related peptide, VIP vasoactive intestinal peptide

(together with other lipid-soluble vitamins such as A, E, and K). This depletion may severely affect bone metabolism leading to osteopenia (i.e., a condition where bone mineral density is reduced) or even osteoporosis (see chapter “Osteoporosis”).

Hepatocyte dysfunction is associated with a reduced insulin clearance. Subsequent hyperinsulinemia may contribute to downregulation of

insulin receptors and may lead to glucose intolerance and hepatogenous diabetes [14]. In contrast, impaired gluconeogenesis or lack of glycogen stores characterizes overt liver failure and can lead to hypoglycemia.

Under physiological conditions, the nitrogenous products of amino acid catabolism are metabolized by the liver through the urea cycle



and glutamine synthesis (see chapter “[Overview](#)” under the part “Liver”) [15]. However, in cirrhosis, nitrogen homeostasis is disrupted, either because ammonia production exceeds urea cycle capacity (mainly by increased gut bacterial ammoniogenesis) or because the liver is unable to metabolize ammonia due to parenchymal insufficiency and portal blood shunting [16]. The skeletal muscle and kidneys are also regulators of ammonia concentration (by ammonia uptake and excretion). However, during cirrhosis, their compensation progressively fails due to muscle wasting and renal impairment, and subsequently, the blood-brain barrier is crossed by an excess of ammonia that accumulates within the astrocytes. The consequent osmotic and inflammatory damage as well as neurotransmission impairment characterize hepatic encephalopathy (HE), one of the most important expressions of metabolic dysfunction in acute and chronic liver disease.

---

## Treatment of Cirrhosis and Related Complications

Treatment of chronic liver disease is manifold and primarily aimed at counteracting the etiological agent (e.g., a hepatitis virus or excessive alcohol consumption) in order to reduce liver inflammation, preventing the formation of scarring tissue and nodular regeneration that characterize the final and irreversible stages of cirrhosis. However, due to delayed diagnosis, poor response, or low compliance to treatment, progression to cirrhosis is sometimes inevitable. When signs of clinically significant PH occur, treatment is aimed to delay and counteract cirrhosis complications. In cases of advanced cirrhosis, liver transplantation remains the only option.

### Portal Hypertension

The management of PH is aimed at preventing further pressure increase and related complications, particularly gastroesophageal bleeding. When the hepatic venous pressure gradient rises beyond 12 mmHg, a critical tension within the

vascular wall results, increasing the risk of vascular rupture. Nonselective  $\beta$ -blockers (NSBBs, Table 1) represent the first-line treatment to directly reduce portal pressure and to allow unopposed  $\alpha$ -adrenergic activity. This produces mesenteric arterial vasoconstriction and therefore reduces portal venous load. Moreover, NSBBs reduce cardiac output and systemic blood pressure contributing to a further decrease in portal flow.

If bleeding occurs despite NSBBs and endoscopic banding of gastroesophageal varices, there may be indication to decompress the portal system by positioning a transjugular intrahepatic portal-systemic shunt (TIPS) [17], i.e., an artificial shunt between the (inflow) portal vein and one of the (outflow) hepatic veins. This invasive procedure is used as a rescue remedy only in severe, selected cases showing complications such as recurrent bleeding, refractory ascites, hydrothorax, and/or hepatorenal syndrome, as in 30–50 % of cases, the shunt leads to portal-systemic HE.

### Ascites and Spontaneous Bacterial Peritonitis

Ascites is treated by reducing fluid retention via anti-aldosterone and loop diuretics and by a salt restriction diet (<90 mmol/day, see also chapter “[Hypertension](#)”). In poor responses to medical treatment, there is indication for paracentesis, a puncturing of the peritoneal cavity to relieve abdominal pressure. This fluid removal must be accompanied with albumin infusion to prevent hypotension, especially in cases of large volume (>5 l) paracentesis [18].

Complications of anti-aldosterone diuretics are hyperkalemia, whereas loop diuretics may lead to hyponatremia, hypokalemia, and hyperammonemia with related HE. A specific side effect of some anti-aldosterones such as spironolactone is gynecomastia, the benign enlargement of breast tissue in males (see chapter “[Prostate cancer](#)”).

Bacterial translocation, especially in patients with tense ascites, may lead to infection of the

**Table 1** Principles of standard treatment in cirrhosis

	Clinical presentation	Treatment option	Therapeutic objectives	Negative metabolic effects
Medical	Portal hypertension (PH)	NSBB, diuretics	NSBB: reduce HR, splanchnic inflow, and portal hypertension Diuretics: reduce fluid retention	<i>NSBB</i> : suppressed adrenergic response  <i>Loop diuretics</i> : dehydration, hyponatremia, HA and HE
	Ascites	Loop diuretics, AA diuretics, low sodium diet	Loop diuretics: reduce fluid retention  AA diuretics: counteract aldosterone	<i>Loop diuretics</i> : dehydration, hyponatremia, HA and HE  <i>AA diuretics</i> : hyperkalemia and gynaecomastia ( <i>spironolactone</i> )
	Hepatorenal syndrome (HRS)	Vasoconstrictors (Terlipressin, Octreotide, Midodrine)  Albumin	<i>Vasoconstrictors</i> : counteract vasodilation  <i>Albumin</i> : increase effective volume to improve renal perfusion	<i>Terlipressin</i> : hypertension, hyponatremia, Ischemia may be triggered in patients with underlying cardiovascular disease
	Spontaneous bacterial peritonitis (SBP)	3rd generation cephalosporins Albumin	Antibiotics: counteract infection Albumin: increase arterial blood volume to prevent renal impairment	
	Hepatic encephalopathy	Osmotic laxatives (lactulose) enemas, non-absorbable antibiotics ( <i>rifaximin/metronidazole</i> ) Dietary measures	Laxatives: reduce colonic transit time and bacterial ammonia production	Laxatives: diarrhea, dehydration and secondary renal impairment hypokalemia
			Antibiotics and enemas: gut decontamination Dietary measures: reduce catabolism and muscle wasting prevention	
Interventional	Gastroesophageal haemorrhage	TIPS	Recurrent bleeding despite medical treatment and variceal band ligation	PSE
	Ascites	TIPS	Refractory ascites	PSE

*NSBB* nonselective  $\beta$ -blockers, *HR* heart rate, *HA* hyperammonemia, *HE* hepatic encephalopathy, *TIPS* transjugular intrahepatic portal-systemic shunt, *PSE* portal-systemic encephalopathy), *AA* anti-aldosterone

ascitic fluid and spontaneous bacterial peritonitis, a life-threatening complication that calls for prompt treatment with antibiotics, such as oral norfloxacin or intravenous 3rd generation cepha-

losporin (see chapter “[Urinary tract infections](#)”), and albumin infusion to improve circulatory function and reduce the risk of hepatorenal syndrome.

## Hepatorenal Syndrome

Hepatorenal syndrome is defined as the occurrence of renal failure in patients with advanced liver disease in the absence of an identifiable cause [19]. It can partially be explained with an altered blood flow and vascular tone in the kidneys, secondary to PH.

The most effective treatments are splanchnic vasoconstricting drugs, which are based on the fact that kidneys do not receive adequate blood flow due to fluid compartmentalization, relative hypovolemia, and increased renal resistances. Vasopressin analogues, such as terlipressin, together with albumin are the treatment of choice to improve circulatory function. TIPS may be beneficial in selected cases. Liver transplantation remains the best option since it resolves the relative impairment of liver and kidney. Renal replacement therapy may be used as bridging therapy before liver transplantation.

## Hepatic Encephalopathy

The objective of HE treatment is to counteract the precipitating causes of hepatic decompensation and target the production and absorption of ammonia [16].

A high-calorie diet maintaining a protein intake of 1.5 g/kg body weight and the use of branched-chain amino acids to counteract muscle wasting are recommended. Laxatives to loosen the stool, such as lactulose, are cathartic (i.e., accelerating defecation), acidify the gut lumen thus inhibiting ammoniogenic bacteria, and trap ammonia in its ionized form ammonium, which cannot be absorbed and is excreted with stool. Nonabsorbable antibiotics, such as neomycin and metronidazole, are used to reduce bacterial derived toxins. However, rifaximin has fewer side effects and a broad spectrum acting on both gram-positive and gram-negative bacteria [20]. The most common side effects of cathartics are dehydration that may exacerbate HE and renal impairment and electrolyte imbalance, especially hypokalemia (as the intestinal fluid contains high

amounts of  $K^+$  due to secretion of  $K^+$  and  $Cl^-$  in the stomach).

Table 1 summarizes the principles of standard treatment in cirrhosis, PH, and associated complications, highlighting the possible negative and positive metabolic consequences.

## Conclusions and Perspectives

Progression to liver cirrhosis is characterized by major hemodynamic and metabolic derangements that lead to a life-threatening systemic condition. Metabolic modifications are secondary to the progressive impairment of liver function but are also dependent on the systemic immune-inflammatory derangement owing to liver-gut axis connections and “disconnections” secondary to portal-systemic shunting. Gut dysbiosis and its impact on innate and acquired immunity play a pivotal role in this clinical context and may disclose important advancements for the identification of more specific therapeutic targets. Along these lines, pathogen-associated molecular patterns represent components of microbial particles that interact with pattern recognition receptors on cells of the immune system (see chapter “Overview” under the part “Immune system”). Moreover, the influence of molecules, such as damage-associated molecular patterns, released as a consequence of liver injury itself, is responsible for triggering the inflammasome pathway and thus “sterile” fibrogenesis and further liver damage [21]. It is within the frame of these molecular interactions that current research is concentrating, aiming to modulate the inflammatory network, interfering with cirrhosis progression, and preventing its complications.

## References

1. Anthony PP, Ishak KG, Nayak NC, Poulsen HE, Scheuer PJ, Sobin LH (1978) The morphology of cirrhosis. Recommendations on definition, nomenclature, and classification by a working group sponsored by the World Health Organization. *J Clin Pathol* 31:395–414

2. Rodríguez-Vilarrupla A, Fernández M, Bosch J, García-Pagán JC (2007) Current concepts on the pathophysiology of portal hypertension. *Ann Hepatol* 6:28–36
3. Ramachandran A, Balasubramanian KA (2001) Intestinal dysfunction in liver cirrhosis: its role in spontaneous bacterial peritonitis. *J Gastroenterol Hepatol* 16:607–612
4. Inagaki T, Moschetta A, Lee YK, Peng L, Zhao G, Downes M, Yu RT, Shelton JM, Richardson JA, Repa JJ, Mangelsdorf DJ, Kliewer SA (2006) Regulation of antibacterial defense in the small intestine by nuclear bile acid receptor. *Proc Natl Acad Sci U S A* 103:3920–3925
5. Wiest R, Garcia-Tsao G (2005) Bacterial translocation (BT) in cirrhosis. *Hepatology* 41:422–433
6. Bonnel AR, Bunchorntavakul C, Reddy KR (2011) Immune dysfunction and infections in patients with cirrhosis. *Clin Gastroenterol Hepatol* 9:727–738
7. Martell M, Coll M, Ezkurdia N, Raurell I, Genescà J (2010) Physiopathology of splanchnic vasodilation in portal hypertension. *World J Hepatol* 2:208–220
8. Pinzani M, Rosselli M, Zuckermann M (2011) Liver cirrhosis. *Best Pract Res Clin Gastroenterol* 25:281–290
9. Ginés P, Berl T, Bernardi M, Bichet DG, Hamon G, Jiménez W, Liard JF, Martin PY, Schrier RW (1998) Hyponatremia in cirrhosis: from pathogenesis to treatment. *Hepatology* 28:851–864
10. Moller S, Henriksen JH (2006) Cardiopulmonary complications in chronic liver disease. *World J Gastroenterol* 12(526–538)
11. Bernardi M, Maggioli C, Zaccherini G (2012) Human albumin in the management of complications of liver cirrhosis. *Crit Care* 16:211
12. Janičko M, Veselý E, Leško D, Jarčuška P (2013) Serum cholesterol is a significant and independent mortality predictor in liver cirrhosis patients. *Ann Hepatol* 12:413–419
13. Malham M, Jørgensen SP, Ott P, Agnholt J, Vilstrup H, Borre M, Dahlerup JF (2011) Vitamin D deficiency in cirrhosis relates to liver dysfunction rather than aetiology. *World J Gastroenterol* 17:922–925
14. García-Compeán D, Jaquez-Quintana JO, Maldonado-Garza H (2009) Hepatogenous diabetes. Current views of an ancient problem. *Ann Hepatol* 8:13–20
15. Frederick RT (2011) Current concepts in the pathophysiology and management of hepatic encephalopathy. *Gastroenterol Hepatol (NY)* 7:222–233
16. Khungar V, Poordad F (2012) Hepatic encephalopathy. *Clin Liver Dis* 16:301–320
17. Krajina A, Hulek P, Fejfar T, Valek V (2012) Quality improvement guidelines for Transjugular Intrahepatic Portosystemic Shunt (TIPS). *Cardiovasc Intervent Radiol* 35:1295–1300
18. Moore CM, Van Thiel DH (2013) Cirrhotic ascites review: pathophysiology, diagnosis and management. *World J Hepatol* 5:251–263
19. European Association for the Study of the Liver (2010) EASL clinical practice guidelines on the management of ascites, spontaneous bacterial peritonitis and hepatorenal syndrome in cirrhosis. *J Hepatol* 53:397–417
20. Bass NM, Mullen KD, Sanyal A, Poordad F, Neff G, Leevy CB, Sigal S, Sheikh MY, Beavers K, Frederick T, Teperman L, Hillebrand D, Huang S, Merchant K, Shaw A, Bortey E, Forbes WP (2010) Rifaximin treatment in hepatic encephalopathy. *N Engl J Med* 362:1071–1081
21. Kubes P, Mehal WZ (2012) Sterile inflammation in the liver. *Gastroenterology* 143:1158–1172

---

## **Part VIII**

# **Fat Tissue**

---

## Overview

Gabriele Schoiswohl, Jules Aljammal,  
and Erin E. Kershaw

---

### Anatomy and Physiology of Fat Tissue

Adipose tissue has evolved into a highly specialized tissue for storing energy in the form of triglycerides (TGs, also called triacylglycerols, or “fat”). It is heterogeneous in cellular composition, location, and function – reflecting its complex role in normal physiology and disease [1]. It is comprised not only of different types of adipocytes (ranging from white to brown) but also other non-adipocyte cell types (such as stromal vascular and immune cells) to form a true multicellular organ [2]. Unlike other organs, adipose tissue is distributed throughout the body where it exhibits location-specific properties. Furthermore, its functions extend well beyond its role in fat storage to a variety of other processes necessary for physiological homeostasis including energy homeostasis, immune homeostasis, and reproductive function [3]. The heterogeneity of adipose tissue is reflected by the variety of clinical disorders that result from adipose tissue dysfunction [4, 5]. Indeed, both adipose tissue excess (obesity) and deficiency (lipodystrophy) result in profound physiological impairments that

promote the metabolic syndrome (see chapter “[Metabolic syndrome](#)”) and cardiovascular disease (see chapter “[Atherosclerotic heart disease](#)”). Adipose tissue dysfunction or excess also contributes to a myriad of other diseases affecting virtually all organ systems including liver disease, i.e., fatty liver and cirrhosis (see chapter “[Cirrhosis](#)”); kidney disease, e.g., diabetic and hypertensive nephropathy (see chapters “[Diabetes mellitus](#)” and “[Hypertension](#)”); pulmonary disease, e.g., sleep apnea; musculoskeletal disease, i.e., arthritis (see chapters “[Osteoarthritis](#)” and “[Rheumatoid arthritis](#)”) and back pain; reproductive disease, i.e., infertility; psychological disease, i.e., depression (see chapter “[Major depressive disorder](#)”); and even cancer (see chapter “[Overview](#)” under the part “[Cancer](#)”) [6]. Thus, adipose tissue is not simply an inert tissue for storing fat, but a highly dynamic tissue required for health and survival. By understanding the unique characteristics of adipose tissue, can we begin to exploit its complexities to treat or prevent disease.

---

### Fat Tissue-Specific Metabolic/ Molecular Pathways and Processes

Adipose tissue is divided into two types: white (WAT) and brown (BAT) (Fig. 1a). WAT is composed of white adipocytes characterized by large, unilocular lipid droplets and sparse mitochondria. The high ratio of fat to mitochondria gives WAT its characteristic white appearance. WAT is

---

G. Schoiswohl • J. Aljammal • E.E. Kershaw (✉)  
Division of Endocrinology and Metabolism,  
Department of Medicine, University of Pittsburgh,  
200 Lothrop Street, Biomedical Science Tower  
E1140, Pittsburgh, PA 15261, USA  
e-mail: [gabriele.schoiswohl@uni-graz.at](mailto:gabriele.schoiswohl@uni-graz.at);  
[aljammalj@upmc.edu](mailto:aljammalj@upmc.edu); [kershawe@pitt.edu](mailto:kershawe@pitt.edu)

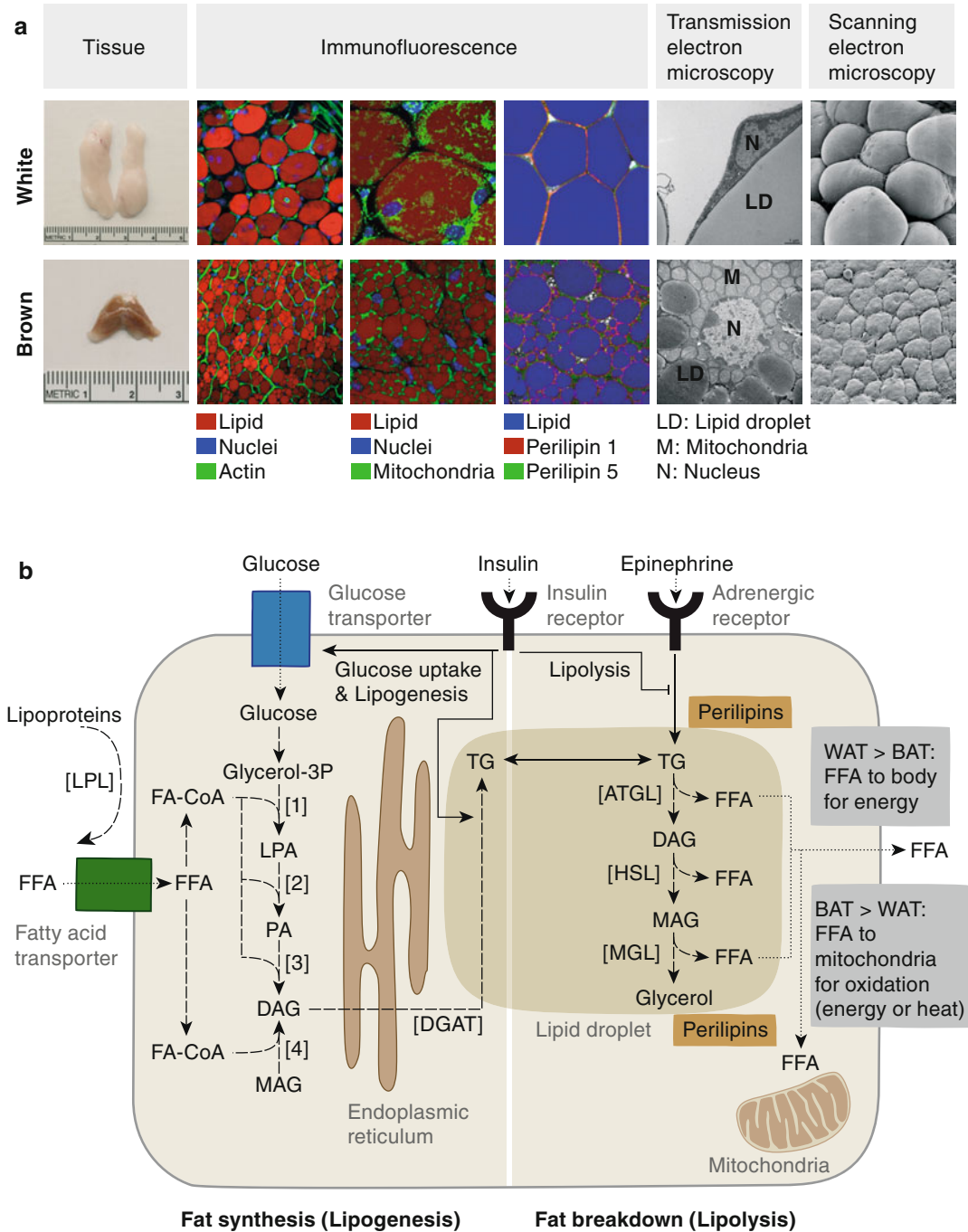

**Fig. 1** Adipocyte morphology and metabolic pathways. **(a)**: Distinguishing features of *white* (WAT, top panel) and *brown* (BAT, bottom panel) adipose tissue. Gross images of murine WAT and BAT (1st image). Immunofluorescence images of WAT and BAT cross sections highlighting adipocyte size (2nd image), mitochondrial content (3rd image), and lipid droplet proteins (4th image). Transmission (5th image) and scanning (6th image) electron microscopy of WAT and BAT. **(b)**: Anabolic (fat synthesis or lipogenesis) and catabolic (fat breakdown or lipolysis) pathways in adipocytes. *LPL* lipoprotein lipase,

*FFA* free fatty acid, *FA-CoA* fatty acyl-CoA, *Glycerol-3-P* glycerol-3-phosphate; [1]=glycerol-3P acyltransferase, *LPA* lysophosphatidic acid, [2]=LPA acyltransferase, *PA* phosphatidic acid, [3]=PA phosphatase, *DAG* diacylglycerol, [4]=monoacyl glycerol acyltransferase, *MAG* monoacylglycerol, *DGAT* DAG acyltransferase, *TG* triglyceride, *ATGL* adipose triglyceride lipase, *HSL* hormone-sensitive lipase, *MGL* MAG lipase (Figure courtesy of Erin E. Kershaw and Donna B. Stolz, University of Pittsburgh's Center for Biological Imaging)

located throughout the body in “depots” but is also spread within and around other tissues where it exhibits location-specific characteristics. WAT is highly specialized for storing large amounts of fat as TGs but also has several other critical functions including mechanical protection, thermal insulation, energy homeostasis, and endocrine factor production. BAT, on the other hand, is composed of brown adipocytes characterized by small, multilocular lipid droplets surrounded by copious large mitochondria. The high ratio of mitochondria to fat gives BAT its characteristic brown appearance. BAT, the presence of which has recently been confirmed in humans, is primarily located along the axial skeleton [7]. In contrast to WAT, BAT is highly specialized for fat combustion to generate heat (thermogenesis). Recently, adipocytes with mixed characteristics (“beige” adipocytes) have been identified, suggesting that specialized adipocytes may interconvert between pro-storage and pro-thermogenic phenotypes [8]. These characteristics make adipose tissue a focus of intense investigation for the treatment of obesity and metabolic disease.

Adipose tissue is exquisitely designed for the regulated storage and release of lipid substrates and possesses all the cellular machinery for both fat synthesis (lipogenesis) and fat breakdown (lipolysis, Fig. 1b). In the setting of energy excess (i.e., after a meal), energy substrates (i.e., glucose or fatty acids) enter the cell where they are converted into fatty acyl-coenzyme As (FA-CoAs). These FA-CoAs are then sequentially esterified to a glycerol backbone by acyl-transferases to form TGs. TGs are stored in lipid droplets. Importantly, lipid droplets are highly dynamic organelles that are associated with a variety of lipid droplet proteins such as those of the perilipin family [9]. For example, perilipin 1 is primarily found in adipocytes where it is integrally involved in lipolysis, whereas perilipin 5 is primarily found in oxidative tissues such as BAT where it is integrally involved in lipid oxidation [9]. In the setting of increased energy demand (i.e., fasting, exercise), free fatty acids (FFA) are sequentially released from TGs by the lipolytic enzymes adipose triglyceride lipase (ATGL), hormone-sensitive lipase (HSL), and monoglyceride lipase (MGL). In WAT, FFAs are

primarily released into the systemic circulation for energy. In BAT, on the other hand, FFAs primarily enter the mitochondria for thermogenesis. These processes are critically important in adipose tissue, the main site of lipid storage and release, but are also present in virtually all cells of the body. Impaired regulation of these fundamental processes contributes to metabolic diseases.

---

### Inside-In: Metabolites of Fat Tissue Affecting Itself

Adipose tissue consists not only of adipocytes but also a variety of other cell types including stromal cells (i.e., fibroblasts, stem cells), vascular cells (i.e., endothelial cells, smooth muscle cells), and immune cells (i.e., macrophages). These cell types interact with each other in an autocrine and paracrine manner [10]. Adipocytes and other cells within adipose tissue secrete bioactive substances known as “adipokines” (adipocyte-derived cytokines) including cytokines (interleukin 6, tumor necrosis factor  $\alpha$ ), complement-like factors (i.e., adiponectin), chemokines (i.e., monocyte chemoattractant protein 1), acute phase reactants (i.e., angiotensin, plasminogen activator inhibitor 1), growth factors (i.e., vascular endothelial growth factor A), adhesion molecules (i.e., vascular cell adhesion molecule 1), hormones (i.e., leptin), and other proteins/peptides (i.e., retinol-binding protein 4, resistin). Adipocytes also express a variety of receptors for factors derived from both local and distant sources [3]. This intra- and intercellular communication influences numerous processes ranging from adipocyte metabolism and development (adipogenesis, maturation, and death) to whole adipose tissue dynamics (i.e., angiogenesis, inflammation). For example, under normal physiological circumstances, adipocyte hypertrophy promotes release of the adipocyte factors leptin and monocyte chemoattractant protein 1 (MCP-1). Leptin activates receptors on adipocytes and elsewhere (i.e., the central nervous system, see chapter “Overview” under the part “Brain”) to directly or indirectly restrict further adipocyte expansion. MCP-1 promotes recruitment and activation of



macrophages that dispose of excess FFAs and dead/dysfunctional adipocytes [11]. Under pathological circumstances, such as severe or prolonged nutritional oversupply, macrophage- or adipocyte-derived inflammatory factors (i.e., interleukin 6 and tumor necrosis factor  $\alpha$ ) lead to a vicious cycle of chronic inflammation, adipocyte lipolysis, and adipocyte dysfunction. This loss of adipose tissue homeostasis and the resulting changes in adipokines and fatty acids interfere with numerous metabolic processes such as insulin signaling, thereby, causing insulin resistance, glucose intolerance, and other features of the metabolic syndrome (see chapter “[Metabolic syndrome](#)”) [12]. Thus, the autocrine and paracrine functions of adipose tissue are essential for maintaining adipose tissue homeostasis but can lead to disease when overwhelmed.

---

### **Inside-Out: Metabolites of Fat Tissue Affecting Other Tissues**

Adipose tissue also interacts with the rest of the body to orchestrate essential physiological processes including energy homeostasis, reproductive function, inflammatory responses, and vascular hemodynamics (Fig. 2, left). Adipose tissue communicates with these distant sites through secretory factors – making it one of the largest endocrine organs in the body. Numerous adipokines have been identified as noted above and are reviewed elsewhere [3]. For example, leptin is a cytokine-like adipokine that signals the adequacy of adipocyte energy stores to the hypothalamus where it acts to decrease energy intake, increase energy expenditure, and regulate reproductive function through complex central nervous system circuits that control both neural (i.e., sympathetic and parasympathetic) and endocrine (i.e., gonadal, adrenal, and thyroid axes) output to the whole body [13]. Adiponectin is a multimeric complement-like adipokine that signals a healthy state of adipose tissue and acts at multiple sites via multiple mechanisms to improve cardiometabolic risk [14]. Conversely, the adipose tissue-derived chemokines and cytokines have systemic inflammatory effects that increase cardiometabolic risk by

promoting insulin resistance, glucose intolerance (see chapter “[Diabetes mellitus](#)”), atherosclerosis (see chapter “[Atherosclerotic heart disease](#)”), and other disease processes [12]. In addition to adipokines, adipose tissue-derived FFAs serve as essential substrates for energy, signaling, and membrane synthesis throughout the body. When present in excess, however, FFAs accumulate in non-adipose tissues where they cause lipid-induced toxicity. This “lipotoxicity” contributes to insulin resistance, diabetes, dyslipidemia, and other features of the metabolic syndrome (see chapters “[Hyperlipidemia](#)”, “[Diabetes mellitus](#)”, and “[Metabolic syndrome](#)”). Thus, the endocrine functions of adipose tissue are essential for maintaining whole-body metabolic homeostasis.

---

### **Outside-In: Metabolites of Other Tissues Affecting Fat Tissue**

Other tissues influence adipose tissue by regulating its production, distribution, metabolism, and function (Fig. 2, right). Adipocytes and other cells within adipose tissue express traditional endocrine hormone receptors (i.e., insulin, glucagon, and growth hormone receptors), nuclear hormone receptors (i.e., glucocorticoid, vitamin D, thyroid hormone, androgen, and estrogen receptors), gut hormone receptors (i.e., gastrin and glucagon-like peptide-1 receptors), cytokine receptors (i.e., leptin, interleukin 6, and tumor necrosis factor  $\alpha$  receptors), catecholamine receptors, peptide receptors (i.e., angiotensin II receptors), and FFA receptors (i.e., Toll4 receptors) [3]. In this way, distant sites communicate with adipose tissue to integrate physiological signals. For example, in the setting of increased energy requirements, catecholamines (i.e., epinephrine) from the central nervous system or adrenal medulla act on adipocyte adrenergic receptors to stimulate lipolysis (Fig. 1b). Conversely, in the setting of increased energy availability, insulin from the pancreas (see chapter “[Overview](#)” under the part “[Pancreas](#)”) acts on adipocyte insulin receptors to facilitate glucose uptake and fat synthesis while simultaneously inhibiting fat breakdown and promoting

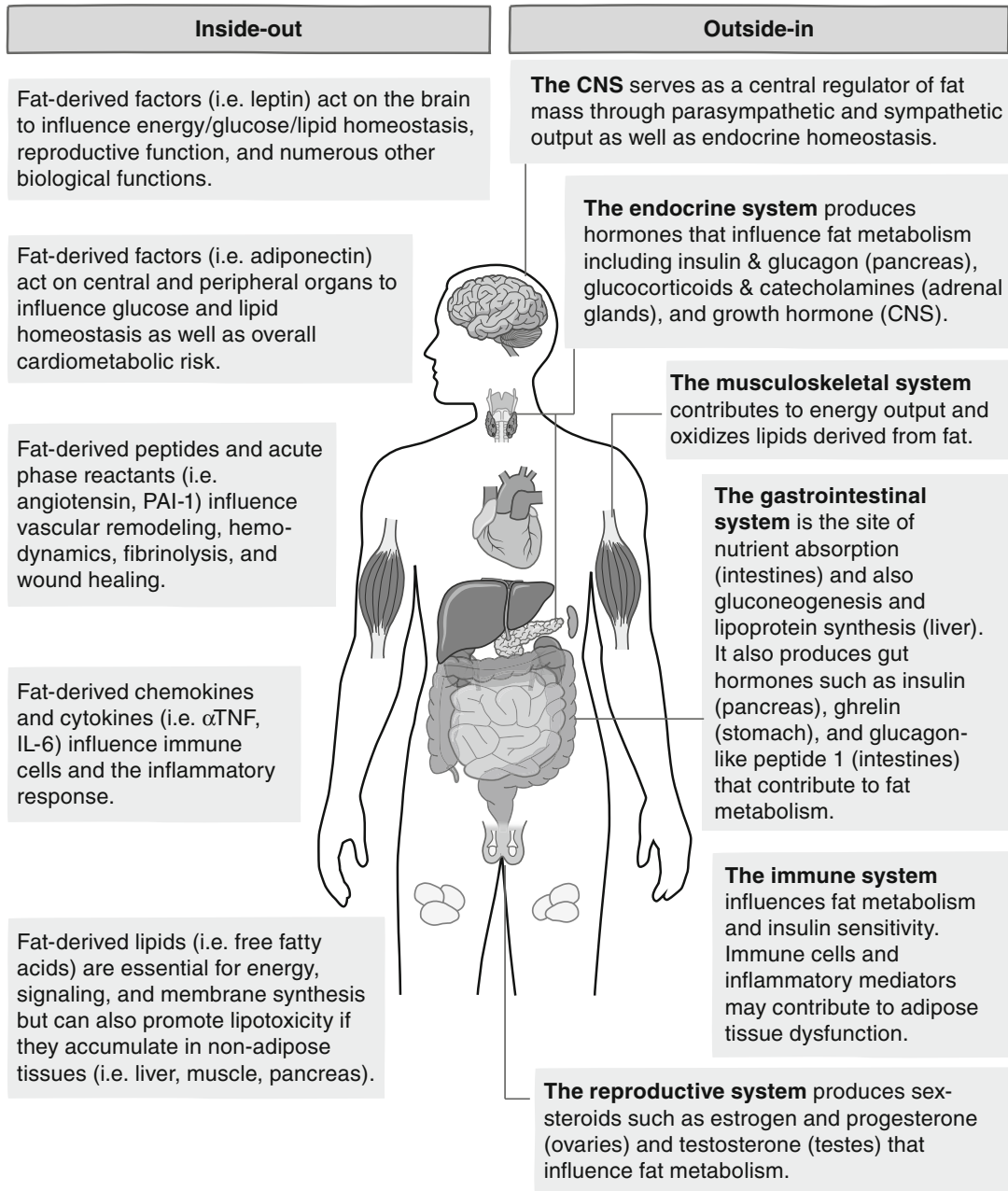

**Fig. 2** Interactions between adipose tissue and other tissues (Figure courtesy of Erin E. Kershaw and Gianna Paniagua)

adipogenesis (Fig. 1b). Interestingly, just as the spectrum of adipocyte-secreted factors varies across adipose tissue depots, so does adipose tissue responsiveness to systemic signals [15]. For example, subcutaneous and breast adipose tissue is particularly responsive to estrogens from the ovaries, whereas visceral adipose tissue is

particularly responsive to glucocorticoids from the adrenal glands. On the other hand, BAT is particularly responsive to temperature (i.e., increasing thermogenesis in response to cold). Thus, adipose tissue is a highly adaptive tissue that responds to both global and local needs of the body.

The body is exquisitely designed to maintain energy homeostasis and adiposity, and yet the global epidemic of obesity and obesity-associated diseases continues to grow [16, 17]. Numerous intrinsic and extrinsic signals influence fat mass and function, either directly by acting on adipocytes themselves or indirectly by influencing other peripheral or central organs. Adipose tissue and the central nervous system integrate these signals and communicate with each other via complex neural and hormonal networks to control energy homeostasis and other physiological processes [16]. Generally, genetic and environmental factors have been considered to be the primary determinants of fat mass. Indeed, recent genome-wide association studies (GWAS) suggest that as much as 70 % of obesity may be attributed to genetic factors [18]. The main environmental factors contributing to fat mass are diet (energy intake) and exercise (energy expenditure). Lifestyle modification, either by decreasing the former or increasing the latter, promotes weight loss by decreasing fat synthesis/storage and/or increasing fat breakdown/oxidation and subsequently improves features of the metabolic syndrome (see chapter “Metabolic syndrome”) [19]. A variety of other factors have also been implicated in adipose tissue dysfunction including microorganisms, epigenetics, sleep patterns, pharmacological agents, and endocrine-disrupting chemicals [20, 21]. However, despite the tremendous progress in understanding adipose tissue biology, many questions remain unanswered.

## Final Remarks

In summary, adipose tissue (“fat”) is a highly complex, heterogeneous, and dynamic organ. Thus, multiple factors (both intrinsic and extrinsic) contribute to its molecular, cellular, and physiological heterogeneity. Only by understanding these factors can we determine how to target them for therapeutic benefit in the fight against the growing epidemic of obesity, metabolic syndrome, and cardiovascular disease.

## References

- Gesta S, Tseng YH, Kahn CR (2007) Developmental origin of fat: tracking obesity to its source. *Cell* 131: 242–256
- Cinti S (2012) The adipose organ at a glance. *Dis Model Mech* 5:588–594
- Kershaw EE, Flier JS (2004) Adipose tissue as an endocrine organ. *J Clin Endocrinol Metab* 89: 2548–2556
- Garg A (2011) Lipodystrophies: genetic and acquired body fat disorders. *J Clin Endocrinol Metab* 96:3313–3325
- Herbst KL (2012) Rare adipose disorders (RADs) masquerading as obesity. *Acta Pharmacol Sin* 33:155–172
- Malnick SD, Knobler H (2006) The medical complications of obesity. *QJM* 99:565–579
- Cypess AM, Lehman S, Williams G, Tal I, Rodman D, Goldfine AB, Kuo FC, Palmer EL, Tseng YH, Doria A, Kolodny GM, Kahn CR (2009) Identification and importance of brown adipose tissue in adult humans. *N Engl J Med* 360:1509–1517
- Wu J, Cohen P, Spiegelman BM (2013) Adaptive thermogenesis in adipocytes: is beige the new brown? *Genes Dev* 27:234–250
- Bickel PE, Tansey JT, Welte MA (2009) PAT proteins, an ancient family of lipid droplet proteins that regulate cellular lipid stores. *Biochim Biophys Acta* 1791:419–440
- Karastergiou K, Mohamed-Ali V (2010) The autocrine and paracrine roles of adipokines. *Mol Cell Endocrinol* 318:69–78
- Cinti S, Mitchell G, Barbatelli G, Murano I, Ceresi E, Faloia E, Wang S, Fortier M, Greenberg AS, Obin MS (2005) Adipocyte death defines macrophage localization and function in adipose tissue of obese mice and humans. *J Lipid Res* 46:2347–2355
- Gregor MF, Hotamisligil GS (2011) Inflammatory mechanisms in obesity. *Ann Rev Immunol* 29: 415–445
- Mantzoros CS, Magkos F, Brinkoetter M, Sienkiewicz E, Dardeno TA, Kim SY, Hamnvik OP, Koniaris A (2011) Leptin in human physiology and pathophysiology. *Am J Physiol Endocrinol Metab* 301: E567–E584
- Turer AT, Scherer PE (2012) Adiponectin: mechanistic insights and clinical implications. *Diabetologia* 55:2319–2326
- Wajchenberg BL (2000) Subcutaneous and visceral adipose tissue: their relation to the metabolic syndrome. *Endocr Rev* 21:697–738
- Flier JS (2004) Obesity wars: molecular progress confronts an expanding epidemic. *Cell* 116:337–350
- Malik VS, Willett WC, Hu FB (2013) Global obesity: trends, risk factors and policy implications. *Nat Rev Endocrinol* 9:13–27

18. O'Rahilly S (2009) Human genetics illuminates the paths to metabolic disease. *Nature* 462:307–314
19. Magkos F, Yannakoulia M, Chan JL, Mantzoros CS (2009) Management of the metabolic syndrome and type 2 diabetes through lifestyle modification. *Annu Rev Nutr* 29:223–256
20. Grun F, Blumberg B (2009) Endocrine disruptors as obesogens. *Mol Cell Endocrinol* 304:19–29
21. McAllister EJ, Dhurandhar NV, Keith SW, Aronne LJ, Barger J, Baskin M, Benca RM, Biggio J, Boggiano MM, Eisenmann JC, Elobeid M, Fontaine KR, Gluckman P, Hanlon EC, Katzmarzyk P, Pietrobelli A, Redden DT, Ruden DM, Wang C, Waterland RA, Wright SM, Allison DB (2009) Ten putative contributors to the obesity epidemic. *Crit Rev Food Sci Nutr* 49:868–913

---

# Metabolic Syndrome

Kana Inoue, Norikazu Maeda,  
and Tohru Funahashi

---

## Introduction to Metabolic Syndrome

The metabolic syndrome (MetS) is a cluster of the most dangerous heart attack risk factors, and up to a quarter of the world's adults might have MetS. In general, cardiovascular diseases (CVD) are the most common cause of death in the world. As most patients show no obvious symptoms prior to the first incident, identification of risk factors and early intervention are important. Hypercholesterolemia is a well-established strong risk factor and is a primary target for the prevention of CVD (Fig. 1, see chapter “Hyperlipidemia”). MetS has been identified as the second target. It was previously called syndrome X [1] and insulin resistance syndrome [2], as low insulin sensitivity occurs frequently in this condition (Fig. 1).

Multiple definitions for the diagnosis of MetS exist, yet all require at least three of the following: (1) obesity, especially abdominal obesity (expressed by increased waist circumference); (2) dyslipidemia, expressed by raised serum levels of

triglycerides or lowered high-density lipoprotein cholesterol (HDLc); (3) elevated blood pressure; (4) and raised fasting plasma glucose (see also chapters “Hyperlipidemia”, “Hypertension”, and “Diabetes mellitus”, respectively) [3]. Moreover, subjects with MetS often show impaired glucose tolerance, insulin resistance, and postprandial abnormalities in lipids.

Abdominal obesity (also termed android obesity [4] or upper body obesity [5]), glucose intolerance, dyslipidemia, and hypertension form “the deadly quartet for CVD” [6]. Studies of abdominal body fat distribution using computed tomography (CT) have revealed that the accumulation of visceral fat in intra-abdominal cavity is more closely related to lipid, glucose, and blood pressure abnormalities rather than absolute body weight or abdominal subcutaneous fat [7]. Thus, the increase of visceral fat area correlates with a cluster of obesity-related risk factors even in mildly obese subjects and is a critical step in MetS development [8]. Finally, from a diagnostic point of view, the waist circumference is an easy-to-measure surrogate marker of visceral fat.

MetS usually occurs in association with sedentary lifestyle (overeating and physical inactivity). It has become a global health problem all over the world and is also increasing in Asian countries, where large numbers of people are living. Although the frequency of people with body mass index (BMI) above 30 is still lower in Asians compared to Caucasians and Africans, MetS, type 2 diabetes, and CVD have also become a serious health problem in Asia.

---

K. Inoue • N. Maeda  
Department of Metabolic Medicine,  
Graduate School of Medicine, Osaka University,  
Osaka, Japan  
e-mail: [kinoue@endmet.med.osaka-u.ac.jp](mailto:kinoue@endmet.med.osaka-u.ac.jp);  
[norikazu\\_maeda@endmet.med.osaka-u.ac.jp](mailto:norikazu_maeda@endmet.med.osaka-u.ac.jp)

T. Funahashi (✉)  
Department of Metabolism and Atherosclerosis,  
Graduate School of Medicine,  
Osaka University, Osaka, Japan  
e-mail: [funahashi@endmet.med.osaka-u.ac.jp](mailto:funahashi@endmet.med.osaka-u.ac.jp)

**Fig. 1** Changes in metabolic syndrome. Accumulation of visceral fat is associated with a cluster of obesity-related risk factors, including hypertension, dyslipidemia, and glucose intolerance. Overproduction of adipocyte-derived inflammatory factors and reduction in antiatherogenic adiponectin level (summarized as “dysregulation of adipokines”) also contribute to the development of cardiovascular disease. *TG* triglycerides (also called triacylglycerols), *HDLc* high-density lipoprotein cholesterol

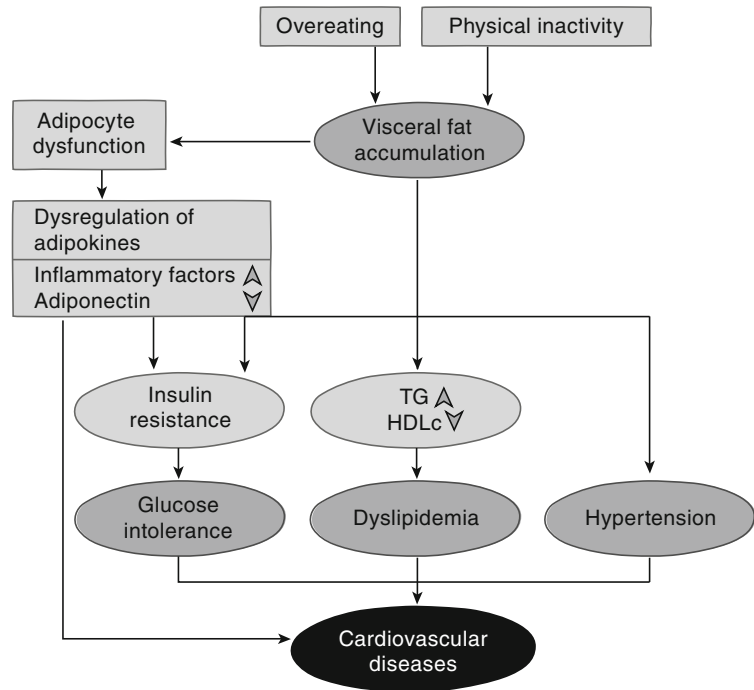

Since dyslipidemia, hyperglycemia and hypertension are common disorders, these risk factors sometimes gather even in a lean individual without visceral fat accumulation. However, MetS is different from a condition randomly clustering multiple risk factors (Fig. 1).

## Pathophysiology of the Metabolic Syndrome

### Visceral Obesity

Visceral adipose tissue is present in the mesentery and omentum, where innumerable vessels run from the digestive tract to the liver. In response to energy demand, visceral adipose tissue rapidly hydrolyzes triglycerides and delivers the products, free fatty acids (FFA) and glycerol, to the liver via the portal vein, which resynthesizes energy substrates (triglycerides and glucose) for distant tissues (see chapters “[Overview](#)” under the part “[Liver](#)” and “[Overview](#)” under the part “[Fat tissue](#)”) [9]. When the visceral fat accumulates, large amounts of FFA are transferred to liver and systemic circulation, leading

to abnormalities in glucose and lipid metabolism, and endothelial dysfunction in MetS.

Another pathogenetic condition in visceral obesity is a dysfunction of adipocytes, especially abnormalities of adipocyte-derived factors, so-called adipokines (see chapter “[Overview](#)” under the part “[Fat tissue](#)”) [10]. Oxidative stress and relative hypoxia due to insufficient blood supply are postulated to cause dysfunction of and damage to hypertrophied adipocytes. The latter secrete various inflammatory adipokines including monocyte chemoattractant protein-1 (MCP-1) as an alarm signal, which recruits macrophages into the adipose tissue. Macrophages surround and remove the damaged adipocytes and produce pro-inflammatory cytokines, such as tumor necrosis factor  $\alpha$  (TNF $\alpha$ ), thus triggering a chronic inflammatory process in the adipose tissue. In addition, hypoxia induces hypoxia-inducible factor 1 $\alpha$ , a transcription factor that enhances the expression of plasminogen activator inhibitor 1 in adipocytes. Importantly, in MetS, these proinflammatory and prothrombotic adipokines spread from the adipose tissue to the whole body via the bloodstream, triggering insulin resistance in muscle [11] and thrombus formation in arteries [12].

Adiponectin is a protein specifically produced by adipocytes and abundantly present in plasma. The protein suppresses (1) TNF $\alpha$ -induced expression of adhesion molecules in vascular endothelial cells, (2) growth factor-induced proliferation of smooth muscle cells, and (3) foam cell transformation of macrophages (see chapter “Atherosclerotic heart disease”) [12]. In addition to these antiatherogenic activities, adiponectin also has insulin-sensitizing activity and stimulates FFA utilization by activation of AMP-dependent protein kinase (AMPK) and peroxisome proliferator-activated receptor  $\alpha$  [13–16]. However, in visceral obesity, plasma levels of adiponectin are decreased. In sum, the dysregulation of adipokines is postulated as a molecular basis of various pathogenetic conditions associated with MetS (Fig. 2) [17].

### Dyslipidemia

Triglyceride-rich VLDL is over-synthesized in visceral obesity. Thus, elevation of plasma triglyceride levels is a major feature of MetS.

After hydrolysis of triglycerides, the size of LDLs decreases (see chapter “Hyperlipidemia”). These smaller LDLs are prone to atherogenic oxidative change. Accumulation of VLDL remnants

and decrease of HDLc promote atherosclerosis (see below).

### Insulin Resistance

Insulin resistance and prediabetic and diabetic conditions are common features of MetS. Impaired metabolism of FFA and dysregulation of adipokines are postulated as mechanisms of insulin resistance in muscle. Muscle cells preferentially metabolize FFA, and glucose uptake is suppressed when the plasma level of FFA is elevated. Additionally, proinflammatory adipokines, such as TNF $\alpha$ , inhibit insulin signaling in muscle and adiponectin expression. Adiponectin normally activates AMPK and increases FFA utilization and thus acts as insulin-sensitizing hormone. However, in MetS, a decrease of adiponectin leads to insulin resistance. In turn, insulin resistance in muscle causes postprandial hyperinsulinemia. Subsequent rise in fasting blood glucose and hyperinsulinemia occur due to hepatic insulin resistance. In this condition, suppression of gluconeogenesis in the fasting state is impaired. The influx of large amounts of FFA from accumulated visceral fat to the liver and the decrease of adiponectin may contribute to hepatic insulin resistance.

**Fig. 2** Effects of treatment of metabolic syndrome on metabolism. Treatment of the multiple risk factors involved in metabolic syndrome apart from increased low-density lipoprotein cholesterol (LDLc, left side) aims to reduce visceral fat or directly targets individual risk factors. Reduction of visceral fat improves dysregulation of several adipokines and the whole cluster of risk factors. LDLc levels can be targeted by reducing cholesterol intake and lipid-lowering therapies. TG triglycerides (also called triacylglycerols), HDLc high-density lipoprotein cholesterol

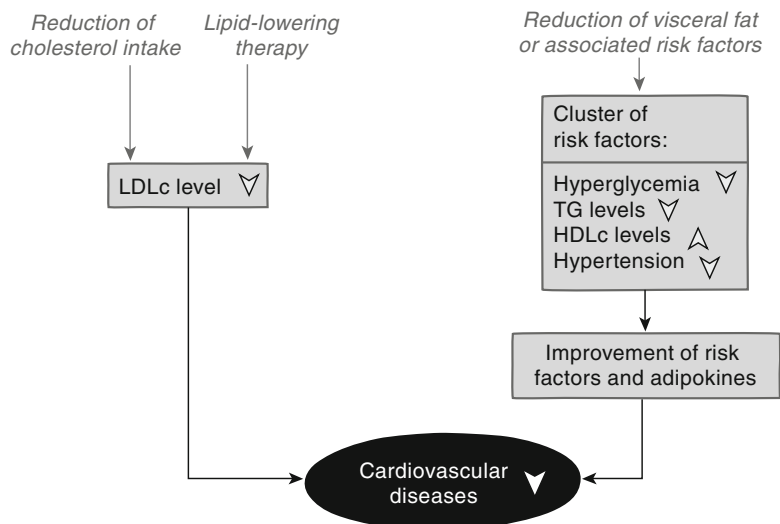



## Hypertension

Hyperinsulinemia promotes urinary reabsorption of sodium chloride in the kidney. Thus, subjects with MetS sometimes develop salt-sensitive hypertension (see chapter “[Hypertension](#)”).

Additionally, adipocytes synthesize angiotensinogen (see chapter “[Overview](#)” under the part “Kidney”) and consequently its levels are high in obesity, further contributing to hypertension.

Elevation of plasma FFA causes vascular endothelial dysfunction, resulting in an impairment of vasodilation activity. Increased sympathetic activity is also reported in subjects with MetS.

## Atherosclerosis

Ultimately, MetS increases the risk of atherosclerosis. Hyperglycemia, hypertension, and increased FFA can damage the vascular endothelium (see chapters “[Diabetes mellitus](#)” and “[Hypertension](#)”). Increased levels of VLDL remnants, small-sized LDLs, and low HDLc levels promote the formation of lipid-rich atheromatous plaques (see chapter “[Atherosclerotic heart disease](#)”). Hypoadiponectinemia, hyperinflammatory-cytokinemia and high levels of thrombotic factors accelerate the atherogenic process and trigger the rupture of plaques with the possibility of a lethal outcome.

## Treatment of Metabolic Syndrome and Impact on Metabolism

Since MetS subjects often have type 2 diabetes [18], dyslipidemia, and hypertension, physicians may prescribe medicines according to these conditions (see chapters “[Diabetes mellitus](#)”, “[Hyperlipidemia](#)”, and “[Hypertension](#)”, respectively). As visceral fat accumulation is a key factor in the progression of MetS and underlies multiple risk factors, the primary management strategy is to reduce accumulated visceral fat [17].

Overwhelming evidence indicates that weight reduction alleviates glucose intolerance,

hypertriglyceridemia, hypo-HDL-cholesterolemia, and hypertension. Reduction of visceral fat ameliorates the cluster of multiple CVD risk factors simultaneously (Fig. 2). As such, a change in lifestyle is the first-line treatment in MetS. This generally includes cardiovascular exercise, generally increased physical activity, and a restricted calorie intake.

To date, there is no single pharmacological treatment available, specifically tailored for the entire cluster of multiple disturbances involved in MetS.

## Perspectives

With increasing comforts in the world, the average life span increased. However, reduced physical activity and excessive intake of nutrition lead to increased visceral fat and obesity causing type 2 diabetes, hypertension, dyslipidemia, and CVD. A strategy to combat and prevent MetS is critically required. Therefore, education and promotion of healthy lifestyle remains our most important and effective tool to prevent and treat MetS.

## References

1. Reaven GM (1988) Banting lecture 1988. Role of insulin resistance in human disease. *Diabetes* 37:1595–1607
2. DeFronzo RA, Ferrannini E (1991) Insulin resistance. A multifaceted syndrome responsible for NIDDM, obesity, hypertension, dyslipidemia, and atherosclerotic cardiovascular disease. *Diabetes Care* 14:173–194
3. Alberti KG, Eckel RH, Grundy SM, Zimmet PZ, Cleeman JI, Donato KA, Fruchart JC, James WP, Loria CM, Smith SC Jr (2009) Harmonizing the metabolic syndrome. *Circulation* 120:1640–1645
4. Vague J (1947) La différenciation sexuelle: facteur déterminant des formes de l’obésité. *Presse Med* 30:339–340
5. Kissebah AH, Vydelingum N, Murray R, Evans DJ, Hartz AJ, Kalkhoff RK, Adams PW (1982) Relation of body fat distribution to metabolic complications of obesity. *J Clin Endocrinol Metab* 54:254–260
6. Kaplan NM (1989) The deadly quartet. Upper-body obesity, glucose intolerance, hypertriglyceridemia, and hypertension. *Arch Intern Med* 149:1514–1520



7. Matsuzawa Y, Fujioka S, Tokunaga K, Tarui S (1992) Classification of obesity with respect to morbidity. *Proc Soc Exp Biol Med* 200:197–201
8. Teramoto T, Sasaki J, Ueshima H, Egusa G, Kinoshita M, Shimamoto K, Daida H, Biro S, Hirobe K, Funahashi T, Yokote K, Yokode M (2008) Metabolic syndrome. *J Atheroscler Thromb* 15:1–5
9. Maeda N, Funahashi T, Shimomura I (2008) Metabolic impact of adipose and hepatic glycerol channels aquaporin 7 and aquaporin 9. *Nat Clin Pract Endocrinol Metab* 4:627–634
10. Funahashi T, Matsuzawa Y (2007) Metabolic syndrome: clinical concept and molecular basis. *Ann Med* 39:482–494
11. Hotamisligil GS, Shargill NS, Spiegelman BM (1993) Adipose expression of tumor necrosis factor- $\alpha$ : direct role in obesity-linked insulin resistance. *Science* 259:87–91
12. Shimomura I, Funahashi T, Takahashi M, Maeda K, Kotani K, Nakamura T, Yamashita S, Miura M, Fukuda Y, Takemura K, Tokunaga K, Matsuzawa Y (1996) Enhanced expression of PAI-1 in visceral fat: possible contributor to vascular disease in obesity. *Nat Med* 2:800–803
13. Matsuzawa Y, Funahashi T, Kihara S, Shimomura I (2004) Adiponectin and metabolic syndrome. *Arterioscler Thromb Vasc Biol* 24:29–33
14. Kadowaki T, Yamauchi T (2011) Adiponectin receptor signaling: a new layer to the current model. *Cell Metab* 13:123–124
15. Ouchi N, Walsh K (2012) Cardiovascular and metabolic regulation by the adiponectin/C1q/tumor necrosis factor-related protein family of proteins. *Circulation* 125:3066–3068
16. Turer AT, Scherer PE (2012) Adiponectin: mechanistic insights and clinical implications. *Diabetologia* 55:2319–2326
17. Kishida K, Funahashi T, Matsuzawa Y, Shimomura I (2012) Visceral adiposity as a target for the management of the metabolic syndrome. *Ann Med* 44:233–241
18. Inoue K, Maeda N, Kashine S, Fujishima Y, Kozawa J, Hiuge-Shimizu A, Okita K, Imagawa A, Funahashi T, Shimomura I (2011) Short-term effects of liraglutide on visceral fat adiposity, appetite, and food preference: a pilot study of obese Japanese patients with type 2 diabetes. *Cardiovasc Diabetol* 10:109

---

**Part IX**

**Lung**

---

## Overview

Martin Zeeb, Andreas Schnapp,  
and Michael-Paul Pieper

---

### Anatomy and Physiology of the Lung

The lung is the human body's respiratory organ, responsible for supply of all tissues and organs with vital oxygen (O<sub>2</sub>) and for disposal of carbon dioxide (CO<sub>2</sub>), the end product of internal respiration and of several metabolic pathways.

The lung, located in the upper thorax, consists of two parts, the right lung further comprising three lobes and the left lung comprising two. Left and right lungs are individually surrounded by a pleural cavity, which consists of two pleurae and the cavity in between. The parietal pleura lines the rib cage, whereas the visceral pleura covers the surface of the lungs. The space between the pleurae is filled with pleural fluid. The pleurae are critically important for breathing motions (see below).

The lungs represent the functional anatomical part of the respiratory system consisting of the

upper and lower respiratory tract, also called upper and lower airways (Fig. 1a). The upper airways comprise nasal cavity, pharynx, and larynx. Their role is to warm and moisten the inhaled air and to protect from noxious agents, mainly filtering them via the nasal turbinates. The nasal cavity also allows smelling. The pharynx is part of both digestive and respiratory systems (see chapter “Overview” under the part “Gastrointestinal tract”) and offers an alternate route of air supply via the mouth. The larynx contains the vocal cords (vocal folds), necessary for human speech. It continues into the lower respiratory tract.

The lower respiratory tract consists of the trachea and the lungs. The trachea bifurcates first into primary bronchi, subsequently into bronchioles, and finally into terminal and respiratory bronchioles, which ultimately give rise to alveolar ductus and sacs (Fig. 1b). In total, the lower respiratory tract branches up to 20 times.

The main function of the lung is to allow gas exchange with the blood, which takes place in respiratory bronchioles and subsequent lung regions and is most pronounced in the alveoli.

On a cellular level, the wall of the conducting airways (trachea, bronchia, and bronchioles) consists of mucosa, submucosa, and adventitia. The mucosa contains a mucus layer (see below) and pseudostratified columnar, ciliated epithelium with mucus-secreting goblet cells, columnar cells, and basal cells. Underneath, the lamina propria is located, a layer of connective tissue, which harbors large amounts of elastin (Fig. 1c). The submucosa contains submucosal glands, which

---

M. Zeeb (✉)

Cardiometabolic Diseases Research,  
Boehringer Ingelheim Pharma GmbH & Co KG,  
Birkendorfer Straße 65,  
88400 Biberach (Riss), Germany  
e-mail: [martin.zeeb@boehringer-ingelheim.com](mailto:martin.zeeb@boehringer-ingelheim.com)

A. Schnapp • M.-P. Pieper

Respiratory Diseases Research,  
Boehringer Ingelheim Pharma GmbH & Co KG,  
Birkendorfer Straße 65,  
88400 Biberach (Riss), Germany  
e-mail: [andreas.schnapp@boehringer-ingelheim.com](mailto:andreas.schnapp@boehringer-ingelheim.com);  
[michael\\_paul.pieper@boehringer-ingelheim.com](mailto:michael_paul.pieper@boehringer-ingelheim.com)

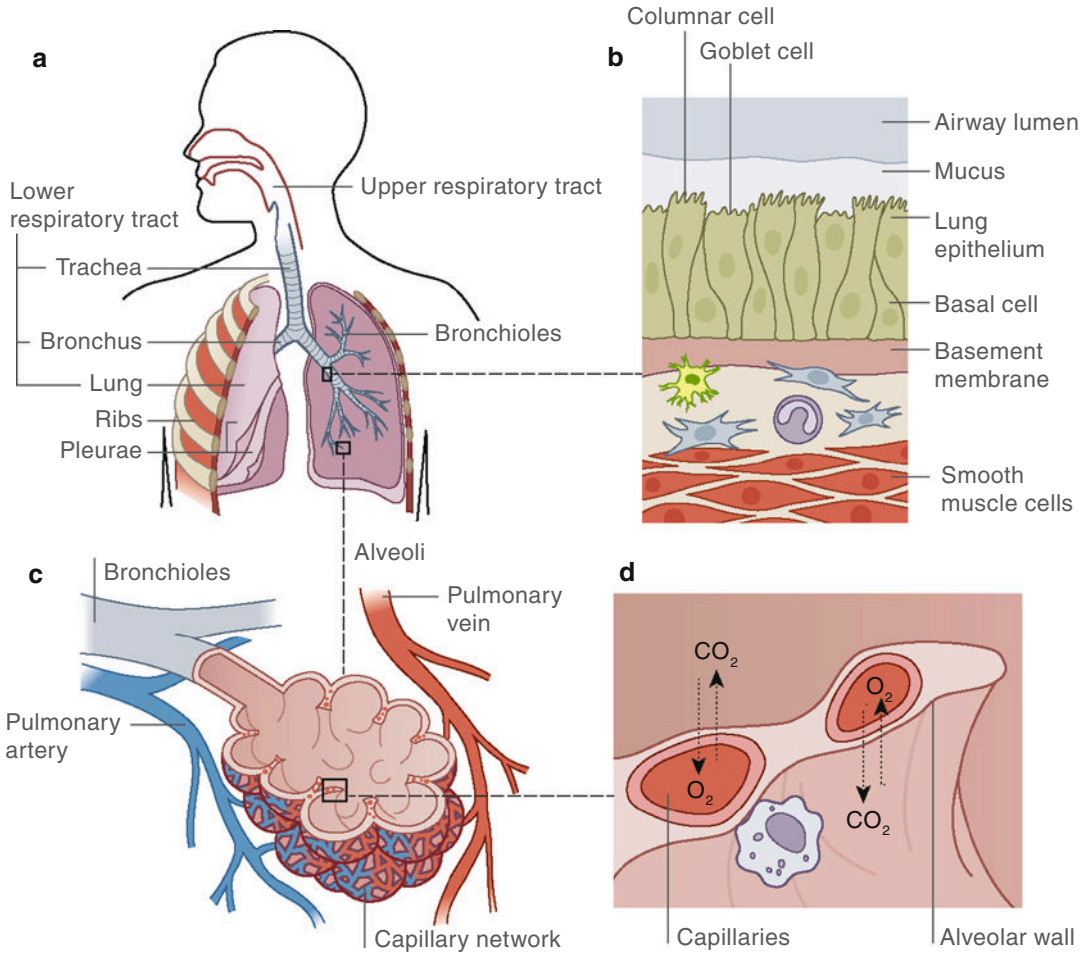

**Fig. 1** Anatomy of the respiratory system. **(a):** Macroscopic overview of upper and lower respiratory tract. **(b):** Magnification of a section through a bronchial wall showing the mucosa and the underlying tunica muscularis. In the mucosa, basal, ciliated columnar cells, and mucus-secreting goblet cells are shown. A submucosal gland is not included due to space constraints albeit the glands are present in bronchia. Whereas goblet cells, glands, and elastic fibers decrease in number concomitant with the length of the cilia towards the smaller airways,

the muscle layer transiently increases. **(c):** Anatomy of an alveolar sack showing the approximate arrangement of individual alveoli and the surrounding dense capillary network. Note that in the lung vasculature, arteries carry oxygen-deficient blood, whereas veins carry oxygen-rich blood (shown in blue and red, respectively). **(d):** Detailed view of a section through an alveolar wall showing thin respiratory surface, movement of gases, and an alveolar macrophage

are connected to the mucosa and also contribute to mucus secretion. In addition, this submucosal layer includes fibroblasts, dendritic cells, and neutrophils, the latter two of which participate in host defense. The adventitia, a fibroelastic connective tissue layer, confines the airways towards the outside. C-shaped rings of hyaline cartilage provide a semirigid outside support to prevent collapse of the airway during inspiration.

As the bronchi decrease in diameter, a gradual transition in the architecture of the epithelium can be observed. The epithelial layer transforms from pseudostratified, columnar epithelium towards a ciliated, simple columnar and finally simple cuboidal epithelium (the shape of a typical respiratory epithelium). Concomitantly, a gradual decrease in the number of goblet cells as well as submucosal glands is seen, whereas Clara

cells emerge. Clara cells, although their function is not completely understood, are thought to play a role in the secretion of surfactant proteins (see below). Furthermore, the amount of elastic tissue decreases and a muscularis mucosae begins to take shape between the lamina propria and the submucosa. The cartilage skeleton is also absent from the bronchioles and smaller airways.

Alveoli (Fig. 1c, d) feature an extremely thin wall of specialized respiratory epithelium to facilitate gas exchange. Most of the alveolar epithelium is covered by small, squamous-like type I pneumocytes. It also includes larger cuboidal type II pneumocytes that produce surfactant (see below) and are thought to be stem cells for both types of pneumocytes. Alveolar macrophages in the alveolar lumen scavenge particulate matter and microorganisms.

In order to perform its function, the lung is extensively vascularized; the alveoli are surrounded by a dense capillary network (Fig. 1c) that can be compared to a columnar hallway. Due to its potential volume and sophisticated regulation, the pulmonary capillaries can act as a large blood reservoir.

The ~300 mio alveoli, each 0.2–0.3 mm in diameter, sum up to a functional area of gas exchange of up to 140 m<sup>2</sup>. The alveolar wall, consisting of alveolar epithelium, minimal interstitium, and endothelium (Fig. 1d), totals to less than 1 μm.

## Mechanism of Breathing

Breathing can be initiated by two similar actions, upward rib movement (chest breathing) or downward movement of the diaphragm (abdominal breathing). As the outer pleura is physically connected to both, it will follow the movement passively. Consequently, during inspiration, the existing low pressure (below atmospheric pressure) in the intrapleural cavity is further decreased and will cause the inner pleura and eventually the lung tissue to follow (as interpleural fluid cannot be expanded). This effectively increases the lung volume and results in an inward movement of air. Puncturing of the pleura is extremely dangerous as lack of the negative intrapleural pressure

effectively hinders lung expansion and thus inhalation (pneumothorax). In contrast, exhalation occurs mainly passively as the lung has the intrinsic tendency to retract due to surface tension in the alveoli and distension of its elastic fibers in the lung tissue. The total lung capacity can amount up to 6 l of air. Yet, even after maximal exhalation, a residual volume of 1.25 l will remain, reflecting the volume of the conducting airways, which do not participate in gas exchange [1].

Any change leading to an obstruction of the airways, like those in asthma and COPD (see chapters “Asthma” and “COPD”) will have detrimental effects. Ventilation deficiencies can be divided into restrictive and obstructive disorders. The former describes a disturbed expansion of the airways (accompanied by reduced total capacity), whereas the latter describes difficulties in conduction and increased inflow or outflow resistance.

Ventilation, diffusion, and convection (blood flow) are of central importance to gas exchange, meaning a constant delivery of fresh air, passive gas exchange with the blood, and ongoing propulsion of the oxygenated blood to keep a stable gradient over the alveolar membrane (see below) [2].

It should be noted that gas exchange with the blood never reaches complete equilibration. Whereas the inhaled gas mixture contains 21 % O<sub>2</sub> and around 0.05 % CO<sub>2</sub>, the exhaled gas mixture still contains 14–16 % O<sub>2</sub> and around 4 % CO<sub>2</sub>.

The respiratory quotient is the relation between exhaled CO<sub>2</sub> and inhaled consumed O<sub>2</sub> (CO<sub>2</sub>/O<sub>2</sub>). It is indicative of the primary metabolic fuel (carbohydrates or fatty acids) at the moment of measurement. As fatty acids require more oxygen for complete oxidation of a single carbon atom, preferential metabolism of fatty acids decreases the respiratory quotient [3].

---

## Lung-Specific Metabolic/Molecular Pathways and Processes

### Mucus Production

Mucus is secreted from goblet cells and submucosal glands in the bronchial epithelium as a viscous fluid containing mucins, water, ions, and

antimicrobial substances such as immunoglobulin A (IgA, see also chapter “[Overview](#)” under the part “Immune system”) and lysozyme. Mucins are heavily glycosylated proteins of high molecular weight.

Mucus is essential to trap inhaled particles and microorganisms and prevent them from reaching and damaging the respiratory epithelium (Fig. 1). Mucus containing bacteria, debris, and inflammatory cells and products is referred to as phlegm. Rhythmic upward propulsion by the cilia on the bronchial epithelium transports mucus and captured particles towards the larynx, where most of it is swallowed or expectorated. Cough is a physiological reflex that aids to eject particles and mucus or phlegm that would otherwise damage or block the airways. Consequently, damage to cilia causes accumulation of mucus and increased ventilatory resistance resulting in obstructive pathology.

### Surfactant Production and Function

Alveoli are subject to dramatic surface tension resulting from the attraction between the molecules of the fluid film that covers the alveolar cell surface. This force supports exhalation but would drive all liquids within the airways to retract, the lung to collapse, and the alveoli to merge into larger vesicles (prohibiting functional gas exchange). However, the stability of the alveoli is ensured by a surface-active agent (surfactant) decreasing surface tension and lubricating the alveolar epithelium. Surfactant is a mixture of proteins and lipids, mainly consisting of lecithin derivatives. Its main lipid components are dipalmitoylphosphatidylcholine (DPPC) molecules that tend to repel each other, thus counteracting the surface tension of the fluid film on the alveolar cell surface; surfactant also contains ~40 % of other phospholipids and ~5 % surfactant-associated proteins and is secreted by type II alveolar epithelial cells.

### Gas Exchange

Gas exchange across the alveolar wall occurs by passive diffusion; a process that can be described

by Fick’s law of diffusion. According to the law, a large exchange area, short diffusion distance, and a constant gradient of substances (across the membrane) facilitate diffusion. All these prerequisites are provided by the unique setup of the alveoli (Fig. 1c, d). Nature of the gas also influences diffusion rate, with CO<sub>2</sub> diffusing more freely over the alveolar membrane than O<sub>2</sub>.

The substance gradient is expressed by the partial pressure of gases (pO<sub>2</sub>, pCO<sub>2</sub>) in the alveolar lumen and in the blood. In order to provide a constant gradient that is as steep as possible, constant and coordinated ventilation and perfusion are of utmost importance. The ratio between ventilation and perfusion, called the ventilation-perfusion coefficient, is relatively constant (0.8–1) among healthy subjects to secure a proper partial pressure gradient and thus gas exchange but can change significantly in some pathologies, e.g., when pulmonary shunts are created by perfusion of non-ventilated alveoli (see chapter “[Community-acquired pneumonia](#)”).

Hemoglobin helps to maintain the gradient by binding of O<sub>2</sub> and thus effectively removing it from the pool of free O<sub>2</sub>. Interestingly, the binding capacity of hemoglobin for O<sub>2</sub> is dependent on pO<sub>2</sub>, with the high partial pressure in the lungs increasing its binding affinity (see chapter “[Overview](#)” under the part “Blood”). Consequently, the contact time of 0.3–0.7 s between an individual erythrocyte and the alveolar wall is already sufficient for saturation of hemoglobin with O<sub>2</sub>.

---

### Outside-In: Metabolites of Other Tissues Affecting the Lung

#### Regulation of Breathing

Regulation of breathing is mediated primarily via the sympathetic and parasympathetic nervous system. Sympathetic activity causes relaxation of smooth muscle cells and thus bronchodilation aiding in inspiration. Parasympathetic activity can constrict the airways, a feature used during exhalation. Overactivation of the parasympatheticus often causes pathological constriction.

However, constriction is more commonly caused by local inflammation, as occurs during asthma and COPD (see chapters “Asthma” and “COPD”, respectively).

The central nervous control center of breathing is represented by neural oscillators located in the medulla oblongata, called the ventral respiratory group. These neurons trigger breathing autonomously but are adjustable and react to systemic need and metabolism (as indicated by the blood gas status). Detection of the blood gas status occurs mainly by arterial chemosensors located in the carotid artery (called glomus caroticum) and also by central chemoception in the brainstem. Among the three prime indicators triggering breathing (i.e., reduced  $pO_2$ , increased  $pCO_2$ , and increased  $H^+$ /decreased pH), increased  $pCO_2$  is the most important signal. There is an almost linear correlation between  $pCO_2$  and breathing induction. At high concentrations, however,  $CO_2$  acts narcotic and may reduce breathing.

The tight chemosensation of  $pCO_2$  has important metabolic implications. Upon hyperventilation (increased/frequent breathing),  $pCO_2$  can be drastically reduced, reducing or even completely inhibiting further breathing. The latter can lead to hypoxemia (reduced  $pO_2$  in the blood) and might remain undetected until unconsciousness occurs. Additionally, hypoxemia-induced breathing lowers  $pCO_2$ , which will in turn decrease breathing activity more efficiently than required based on  $pO_2$  status. Dramatic alterations of blood gases can occur in divers or at high altitudes [4, 5].

Increased  $H^+$  is compensated by hyperventilation, causing an increased exhalation of  $CO_2$ . By this mechanism, the lung is a major regulator of blood pH along with the kidneys (see below). Again, the expected response to high  $H^+$  is stymied by the “more effective” response to altered  $pCO_2$ .

## Breathing and Pathologies

Observation of breathing patterns can hint at specific underlying pathologies and disturbances.

For example, in altitude sickness, reduced  $pO_2$  in the atmosphere causes increased heart rate and

deep and more frequent breathing (to incorporate sufficient  $O_2$ ). However, this effectively lowers  $pCO_2$  in the blood causing decreased breathing, which again causes hypoxemia, or even apnea (lack of breathing). The resulting periodic breathing pattern is known as Cheyne-Stokes breathing.

Decreased atmospheric pressure at high altitudes can cause pulmonary edema. If the intrapulmonary pressure is too low compared to the blood pressure, plasma fluid leaks into the alveoli. More frequently, left ventricular heart failure results in pulmonary edema, which is characterized by superficial breathing.

In contrast, hypercapnia (abnormally increased  $pCO_2$  in the blood) and acidosis are characterized by extremely deep breathing called Kussmaul breathing (see below).

## Breathing and Treatment

It should be noted that drug delivery via the lungs, e.g., using inhalation devices, offers great therapeutic potential, not only for treatment of asthma and COPD. Inhaled drug delivery harnesses immediate contact to mucosal surfaces and easy translocation to the blood across the alveolar membrane [6].

---

## Inside-Out: Metabolites of the Lung Affecting Other Tissues

### Function Under Extreme Conditions

Hypercapnia not only increases breathing but also causes arousal and initiates head turning during sleep. It can be caused by lung function deficits (as in several lung diseases), breathing depression, inhalation of increased concentrations of  $CO_2$  (as in rebreathing), and long-term artificial respiration. It is often accompanied by respiratory acidosis due to the formation of carbonic acid ( $H_2CO_3$ ) and subsequent dissociation to  $H^+$  and bicarbonate ( $HCO_3^-$ ).

Respiratory acidosis (blood pH <7.35) causes clinical symptoms, such as blue, cyanotic lips; increased heart rate (tachycardia); and pulmonary



**Fig. 2** Specific metabolism of the lung and interaction with other organs and tissues.  $pCO_2$  partial pressure of  $CO_2$  in the blood, *EPO* erythropoietin, *ACE* angiotensin-converting enzyme, *AT* angiotensin

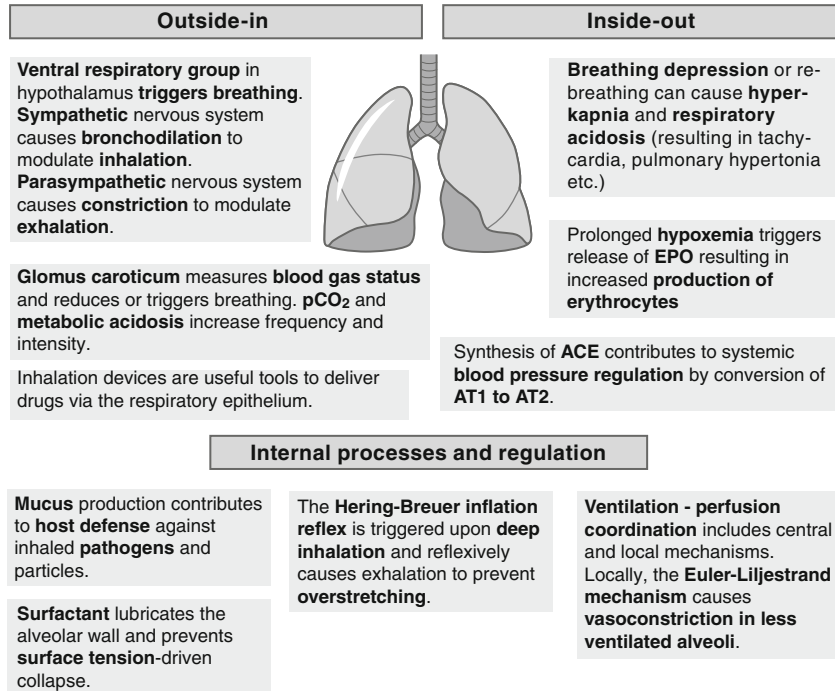

hypertonia (Fig. 2). Respiratory acidosis is commonly corrected by  $H^+$  excretion in the kidney (see chapter “Overview” under the part “Kidney”).

Acidosis can also occur due to increased anaerobic glycolysis (causing increased lactic acid concentrations) and ketone body synthesis resulting in ketoacidosis (due to increased acetoacetic acid and 2-hydroxybutyric acid concentrations). This metabolic acidosis occurs during shock or, more commonly, deregulated diabetes (coma diabeticum, see chapter “Diabetes mellitus”). Other forms of metabolic acidosis originate from decreased  $H^+$  excretion (as occurs in kidney disease, see chapter “Chronic kidney disease”), increased  $HCO_3^-$  excretion, or acid intoxication (e.g., by acetylsalicylic acid).

If acidosis exceeds the buffer capacity of the blood, it can be fatal. In general, metabolic deregulation is antagonized by respiratory mechanisms, and vice versa. Thus, severe metabolic acidosis is characterized by Kussmaul breathing, a deep and gasping breathing pattern, which is a sign of life-threatening conditions.

Prolonged reduced oxygen levels (hypoxemia) trigger release of erythropoietin (EPO) via

hypoxia-inducible factor (HIF)- $1\alpha$ . This increases production of hemoglobin and thus facilitates oxygen transport (see chapter “Overview” under the part “Blood”), e.g., during adaptation to high altitudes [7].

**Other Functions**

Finally, the lung also performs functions different from gas exchange. For example, lung endothelium synthesizes angiotensin-converting enzyme (ACE) that converts angiotensin I to angiotensin II (Fig. 2). This conversion is of critical importance to blood pressure homeostasis (see chapters “Overview” under the part “Kidney” and Hypertension) and a protective role of ACE in the lung has been reported [8].

**Coordination with Other Organs**

The function of the lung needs to be coordinated with other organs in particular with the cardiovascular system. For example, increased breathing is only useful if heart rate and blood



convection are also increased. Coordination with sensory reactions, such as speech and cough reflex (see above), is also mandatory. These coordinating responses involve multiple centers in the CNS and are too complex to elaborate in this brief introduction [9].

---

## Inside-In: Metabolites of the Lung Affecting Itself

### Lung Perfusion and Usage of Alveoli

As mentioned above, the ventilation-perfusion coefficient is critical for gas exchange. Concomitantly, only ~50 % of alveolar capillaries are perfused at rest as only a similar amount of alveoli is ventilated. Increased oxygen demand increases perfusion and activates reserve capillaries. Simultaneously, breathing is intensified to ventilate corresponding alveoli (via central regulatory mechanisms). While standing, the base of the lung is much more perfused than the tips, due to a gradient in hydrostatic blood pressure.

Perfusion is also regulated locally, as less ventilated alveolar regions cause local vasoconstriction (called hypoxic pulmonary vasoconstriction) to prevent perfusion of non-ventilated alveoli and shunting of deoxygenated blood to the heart. This mechanism is known as the Euler-Liljestrand mechanism and is driven by local hypoxia (Fig. 2). Hypoxia is sensed by oxygen-sensitive potassium channels, which close and thus cause depolarization of smooth muscle cells leading to  $Ca^{2+}$  influx and vasoconstriction.

### Reflexes and Internal Regulation

Several internal reflexes are directed at pulmonary protection. These originate from the lung and are mediated by the nucleus tractus solitarius in the CNS. A major mechanism is the Hering-Breuer inflation reflex, which is induced upon deep inhalation and aims to prevent overstretching of lung tissue. In reflexive manner, it triggers exhalation (Fig. 2). Another protective mechanism is the reflex induction of coughing in response to inhaled particles, fluids, or noxious gases.

## Final Remarks

The lungs are critical regulators but also effectors of human metabolism, as they are both starting and end point of internal respiration. By supplying  $O_2$  and removing  $CO_2$ , the lungs are implicated in virtually all metabolic pathways of which energy metabolism surely is the most influential. Due to the unique composition and organization of the conducting and respiratory tracts that permit its efficient function, the lung is also susceptible to both extrinsic and intrinsic pathologies. Microorganisms can easily enter with the airflow, and pathological disturbance of the delicate balance between ventilation, diffusion, and convection has an immediate and sometimes dramatic effect on respiratory function and associated metabolism.

---

## References

1. Thews G (2000) Lungenatmung. In: Schmidt RF, Thews G, Lang F (eds) *Physiologie des Menschen*, 28th edn. Springer, Heidelberg, pp 565–590, German
2. West JB (2011) *Respiratory physiology: the essentials*, 9th edn. Lippincott Williams & Wilkins, Philadelphia/London
3. Levitzky M (2013) *Pulmonary physiology*, 8th edn. McGraw-Hill Medical, New York
4. Francis TJR, Mitchell SJ (2003) Pathophysiology of decompression sickness. In: Brubakk AO, Neuman TS (eds) *Bennett and Elliott's physiology and medicine of diving*, 5th Rev edn. Saunders, Philadelphia, USA, pp 530–556
5. Grocott MP, Martin DS, Levett DZ, McMorrow R, Windsor J, Montgomery HE (2009) Arterial blood gases and oxygen content in climbers on Mount Everest. *N Engl J Med* 360:140–149
6. Labiris NR, Dolovich MB (2003) Pulmonary drug delivery. Part I: physiological factors affecting therapeutic effectiveness of aerosolized medications. *Br J Clin Pharmacol* 56:588–599
7. Kenneth NS, Rocha S (2008) Regulation of gene expression by hypoxia. *Biochem J* 414:19–29
8. Imai Y, Kuba K, Rao S, Huan Y, Guo F, Guan B, Yang P, Sarao R, Wada T, Leong-Poi H, Crackower MA, Fukamizu A, Hui CC, Hein L, Uhlrig S, Slutsky AS, Jiang C, Penninger JM (2005) Angiotensin-converting enzyme 2 protects from severe acute lung failure. *Nature* 436:112–116
9. Feldmann JL (1986) Neurophysiology of breathing in mammals. In: Bloom FE (ed) *Handbook of physiology; section I: the nervous system; volume IV: intrinsic regulatory systems of the brain*. American Physiological Society, Bethesda, pp 463–524

---

# Asthma

Kenji Izuhara, Shoichi Suzuki, Kazuhiko Arima,  
Shoichiro Ohta, Masako Inamitsu,  
and Ken-ichi Yamamoto

---

## Introduction to Asthma

Asthma is one of the most common chronic diseases, with an estimated 300 million people affected worldwide [1]. The incidence of asthma continues to increase, especially among children. Asthma is defined by its clinical, physiological, and pathological characteristics [1]. Its predominant clinical feature is recurrent episodes of wheezing, breathlessness, chest tightness, and coughing, particularly at night or in the early morning. The main physiological feature is episodic obstructed breathing characterized by constricted expiratory airways, leading to asthma's clinical features. The dominant pathological feature is chronic inflammation of the airways associated with airway hyperresponsiveness, which obstructs or limits airflow when airways are exposed to various risk factors. Chronic

inflammation is characterized as infiltration of inflammatory cells (e.g., mast cells, eosinophils, and T cells; see chapter “**Overview**” under the part “Immune system”) and is sometimes associated with airway structural changes called “remodeling” such as mucus hyperproduction by epithelial cells, subepithelial fibrosis by fibroblasts, hypertrophy and/or hyperplasia of airway smooth muscle cells, and proliferation of blood vessels.

A number of factors affect an individual's risk of developing asthma. These are divided into host (genetic) factors and environmental factors. Candidate-gene approaches have been applied to identify genetic variants associated with asthma [2]. Recently, genome-wide association studies (GWAS) have been performed to investigate the association of genotypes with asthma without limiting the sample by a predetermined hypothesis, leading to the discovery of novel susceptible genes [3–6]. Environmental factors include allergens, such as house dust mites, cockroaches, animal dander, fungi, pollens; infections, such as respiratory syncytial virus; occupational sensitization; tobacco smoke; air pollution; and diet (e.g., cow's milk, soy protein, and unsaturated fatty acids) [1]. Occupational sensitization can occur due to high molecular-weight substances (>5,000 Da) such as cereals, seafood, natural rubber latex, enzymes, animal-derived allergens, adhesives, and certain gums used in the printing industry and due to low molecular-weight agents (<5,000 Da) such as acid anhydrides and platinum salts.

---

K. Izuhara (✉) • S. Suzuki • K. Arima • M. Inamitsu  
K.-i. Yamamoto  
Division of Medical Biochemistry,  
Department of Biomolecular Sciences,  
Saga Medical School,  
5-1-1 Nabeshima, Saga 849-8501, Japan  
e-mail: [kizuhara@cc.saga-u.ac.jp](mailto:kizuhara@cc.saga-u.ac.jp);  
[shoichi3@cc.saga-u.ac.jp](mailto:shoichi3@cc.saga-u.ac.jp); [arimaka@cc.saga-u.ac.jp](mailto:arimaka@cc.saga-u.ac.jp);  
[sm5167@cc.saga-u.ac.jp](mailto:sm5167@cc.saga-u.ac.jp); [sm5714@cc.saga-u.ac.jp](mailto:sm5714@cc.saga-u.ac.jp)

S. Ohta  
Department of Laboratory Medicine,  
Saga Medical School, 5-1-1, Nabeshima,  
Saga 849-8501, Japan  
e-mail: [ohtasho@cc.saga-u.ac.jp](mailto:ohtasho@cc.saga-u.ac.jp)

## Pathophysiology of Asthma and Metabolic Alterations

Helper T cells are divided into effector T cells that accelerate immune responses and regulatory T cells ( $T_{reg}$ ) that inhibit immune responses (see also chapter “Allergies”). Effector T cells are further classified based on the secreted cytokine profiles into  $T_{h1}$ ,  $T_{h2}$ ,  $T_{h9}$ ,  $T_{h17}$ ,  $T_{h22}$ , and  $T_{h}$  (see chapter “Overview” under the part “Immune system”) [7]. Type 2 immune responses triggered by  $T_{h2}$  cells are the most dominant in asthma. Cytokine expression profiles in airway tissues show that almost half 50–70 % of adult asthma patients show a  $T_{h2}$  type whereas the other half the rest show a non- $T_{h2}$  type [8]. Obesity or smoking is involved in the patho-mechanism of non- $T_{h2}$ -type asthma; however, it is heterogeneous and less understood. In contrast, the patho-mechanism of  $T_{h2}$ -type asthma is well understood and discussed in the following sections.

Most asthma begins in association with sensitization of the airways to common aeroallergens (Fig. 1) [9]. Dendritic cells (DCs), specialized antigen-presenting cells residing under the mucosa, take up allergens after activation via Toll-like receptors (see chapter “Overview” under the part “Immune system”). Then, after processing, DCs present small allergen-derived peptides on MHC class I/II. By recognizing these peptides presented, naive T cells differentiate into  $T_{h2}$  cells, which secrete type 2 cytokines such as interleukins (IL-)4, (IL-)5, (IL-)9, and (IL-)13. These cytokines play an important role in airway inflammation by activating immune cells (such as B cells, mast cells, eosinophils, and basophils) and/or nonimmune cells (e.g., epithelial cells, fibroblasts, and smooth muscle cells).

Besides invading the host via damaged epithelium followed by uptake into DCs, allergens directly act on epithelial cells through Toll-like receptors, inducing production of  $T_{h2}$ -promoting chemokines, such as C-C motif ligand (CCL) 17 and CCL22, and epithelial cytokines, such as thymic stromal lymphopoietin (TSLP), IL-25, IL-33, and granulocyte macrophage-colony-stimulating factor (GM-CSF) [9, 10]. TSLP and GM-CSF have  $T_{h2}$ -polarizing activities on DCs. TSLP, IL-25, IL-33, and GM-CSF all interact with effector cells

of allergic responses (mast cells, basophils, and eosinophils) to enhance their inflammatory responses. Basophils provide an early source of IL-4 to enhance  $T_{h2}$  development initiated by DCs. IL-33 and IL-25 activate group 2 innate lymphoid cells, a novel type of innate immune cells [11], to secrete type 2 cytokines, mainly IL-5 and IL-13, enhancing type 2 immune responses (Fig. 1).

The significance of other T-cell subsets such as  $T_{h9}$ ,  $T_{h17}$ , invariant natural killer T (iNKT) cells, and  $T_{reg}$  in the pathogenesis of bronchial asthma in combination with or independent of  $T_{h2}$  cells has been suggested in mouse models of asthma. However, the significance of these T-cell subsets in asthma patients is largely unknown.  $T_{h17}$  cells are induced by a combination of IL-6 and transforming growth factor  $\beta$  (TGF- $\beta$ ).  $T_{h17}$  cells are producers of IL-17A, IL-17F, and IL-22 that induce C-X-C motif ligand-8 (CXCL8 or IL-8) expression in airway smooth muscle cells, thus causing infiltration of neutrophils. In mice, allergen exposure induces  $T_{h17}$  cells, and genetic disruption of the genes corresponding to IL-17A and IL-17F abolishes asthma-like phenotypes together with neutrophilia [12, 13], indicating the possible involvement of  $T_{h17}$  in non- $T_{h2}$ -type asthma.  $T_{h9}$  cells, characterized as the major IL-9-producing cells, are induced by a combination of IL-4 and TGF- $\beta$ ; however, the specific transcription factor has not been characterized.  $T_{reg}$  cells expressing the transcription factor FOXP3 and the cell surface markers cluster of differentiation (CD) 4 and CD25 help to decrease immunological responses and to induce immune tolerance. Experimentally, adoptive transfer of antigen-specific  $T_{reg}$  cells suppresses allergic inflammation via secretion of IL-10 [14], whereas depletion of  $T_{reg}$  cells enhances airway inflammation [15]. iNKT cells recognize the glycolipid  $\alpha$ -/ $\beta$ -galactosylceramide presented by CD1d and are shown to be involved in airway inflammation, synergistically with  $T_{h2}$  cells or independently [16].

---

## Treatment of Asthma and Airway Inflammation

Although asthma used to be viewed as a single disease, it has become accepted that asthma is a heterogeneous complex of phenotypes [17].

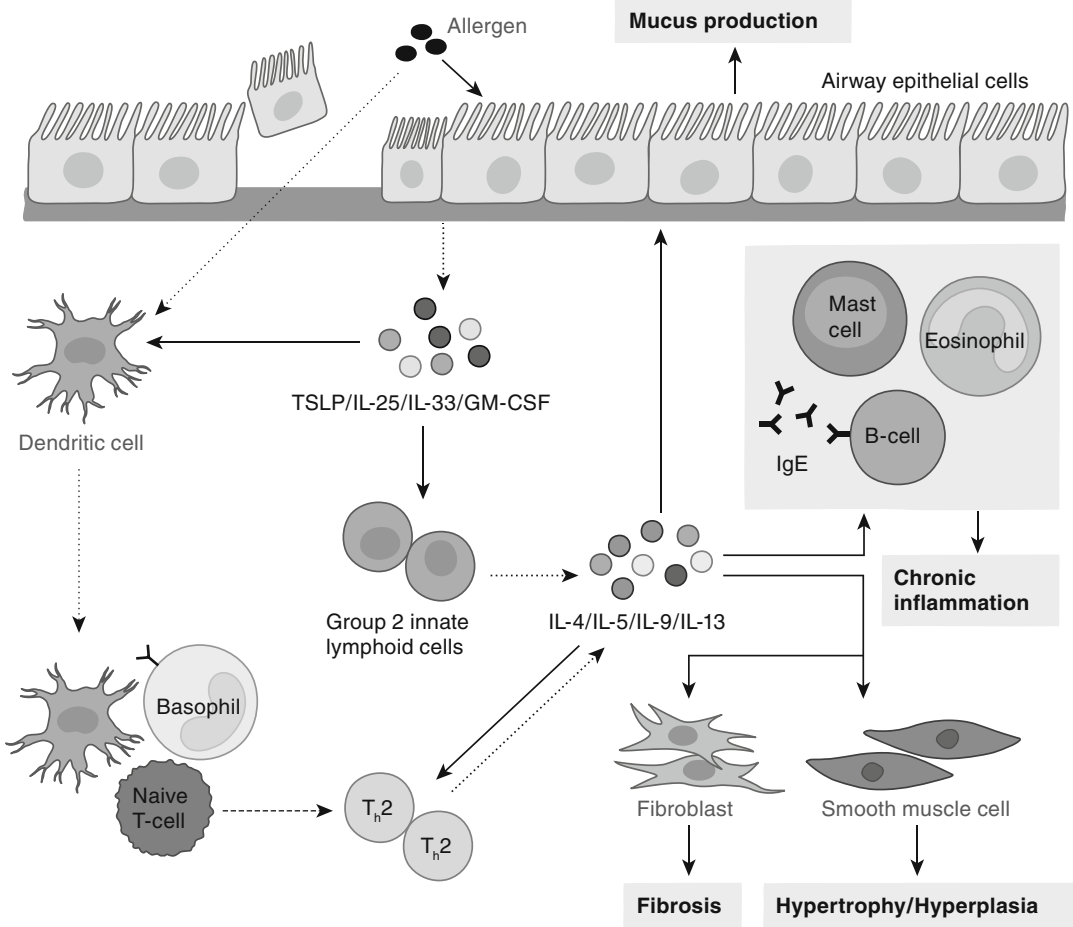

**Fig. 1** Type 2 immune responses in asthma. In the classical pathway, dendritic cells (DCs) take up allergens and present allergen-derived peptides to naive T cells (*lower left*). T cells differentiate into  $T_H2$  cells (*bottom center*), which secrete type 2 cytokines such as interleukin (IL)-4, (IL)-5, (IL)-9, and (IL)-13. These cytokines activate immune cells (B cells, mast cells, and eosinophils) and/or nonimmune cells (epithelial cells, fibroblasts, and smooth

muscle cells). In another pathway, allergens directly act on epithelial cells, inducing production of epithelial cytokines, such as thymic stromal lymphopoietin (TSLP), IL-25, IL-33, and granulocyte macrophage-colony-stimulating factor (GM-CSF). TSLP, IL-25, and IL-33 act on DCs or group 2 innate lymphoid cells enhancing type 2 immune responses. Basophils enhance  $T_H2$  development

Recognizing this heterogeneity is important in evaluating the efficacy of inhaled glucocorticosteroids, the most effective agents currently available [1]. Inhaled corticosteroids are ineffective for 5–10 % of asthma patients, and the medical costs of these patients account for 50 % of the overall cost of treating asthma [18, 19]. Understanding the varying types of asthma will allow stratification of asthma patients and better treatment.

Although the concept of extrinsic (allergic) vs. intrinsic (nonallergic) asthma was proposed before, it has been shown that expression of  $T_H2$  cytokines

and efficacy of inhaled corticosteroids are invariant in these two groups [17]. As a result of application of many phenotypes for clustering asthma patients, age at disease onset (early vs. late) and association of  $T_H2$  response ( $T_H2$  type vs. non- $T_H2$  type) are well accepted as useful stratification (Fig. 2) [17]. Early-onset  $T_H2$ -type asthma includes mild to severe patients and is associated with other allergic diseases. Inhaled corticosteroids are effective, and  $T_H2$ -targeted agents (e.g., anti-immunoglobulin E (IgE) antibody, anti-IL-5 antibody, and IL-4/IL-13 antagonists) will be useful. Late-onset  $T_H2$ -type

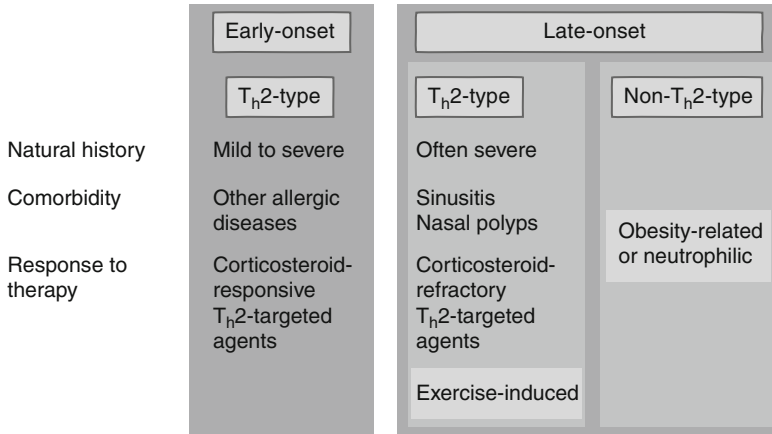

**Fig. 2** Categorization of asthma patients (Adapted from Wenzel [17]). Asthma patients are categorized by disease onset (early vs. late) and association of T<sub>H</sub>2 response (T<sub>H</sub>2 type vs. non-T<sub>H</sub>2 type). Most early-onset patients are T<sub>H</sub>2 type (*left column*). This type is mild to severe, associated with other allergic diseases, and responsive for inhaled

corticosteroids and T<sub>H</sub>2-targeted agents. Late-onset T<sub>H</sub>2 type (*center*) is often severe, associated with sinusitis and nasal polyps, and refractory for inhaled corticosteroids but responsive for T<sub>H</sub>2-targeted agents. Exercise-induced asthma is included in this type. Late-onset non-T<sub>H</sub>2 type contains obesity-related or neutrophilic asthma

asthma affects patients more severely than early-onset types. Sinusitis or nasal polyps are often observed in this type. Since inhaled corticosteroids are less effective for this type, T<sub>H</sub>2-targeted agents are more promising. The T<sub>H</sub>2 type is present in up to 50 % of asthma patients. Exercise-induced asthma is included in this category. Fractional exhaled nitric oxide (FeNO), sputum eosinophils, and serum periostin can be biomarkers for T<sub>H</sub>2-type asthma. FeNO is produced by inducible nitric oxide synthase (iNOS) that is induced in airway epithelial cells by IL-13. Periostin is a component of thickened basement membranes of asthma patients downstream of IL-4/IL-13 signals [20] and appears to be a promising surrogate biomarker for high IL-13 expression [21].

Non-T<sub>H</sub>2-type asthma affects the remaining 50 % of patients and is mostly adult onset. This type includes obesity-related or neutrophilic asthma (see above).

## Perspectives

Understanding of the pathogenesis of asthma has increased along with an increased knowledge of the immunological responses involved. Based on this, several new drugs against asthma are now in development. For the future, it is important to

elucidate the heterogeneity of asthma to establish a better treatment of the patients in each.

## References

- GINA executive committee: Global strategy for asthma management and prevention updated 2012. <http://ginasthma.org/2012>
- Vercelli D (2008) Discovering susceptibility genes for asthma and allergy. *Nat Rev Immunol* 8: 169–182
- Moffatt MF, Kabesch M, Liang L et al (2007) Genetic variants regulating ORMDL3 expression contribute to the risk of childhood asthma. *Nature* 448:470–473
- Moffatt MF, Gut IG, Demenais F et al (2010) A large-scale, consortium-based genomewide association study of asthma. *N Engl J Med* 363:1211–1221
- Sleiman PM, Flory J, Imielinski M et al (2010) Variants of DENND1B associated with asthma in children. *N Engl J Med* 362:36–44
- Hirota T, Takahashi A, Kubo M et al (2011) Genome-wide association study identifies three new susceptibility loci for adult asthma in the Japanese population. *Nat Genet* 43:893–896
- Tangye SG, Ma CS, Brink R et al (2013) The good, the bad and the ugly – TFH cells in human health and disease. *Nat Rev Immunol* 13:412–426
- Woodruff PG, Modrek B, Choy DF et al (2009) T-helper type 2-driven inflammation defines major subphenotypes of asthma. *Am J Respir Crit Care Med* 180:388–395
- Holgate ST (2012) Innate and adaptive immune responses in asthma. *Nat Med* 18:673–683

10. Lambrecht BN, Hammad H (2012) The airway epithelium in asthma. *Nat Med* 18:684–692
11. Licona-Limon P, Kim LK, Palm NW et al (2013) TH2, allergy and group 2 innate lymphoid cells. *Nat Immunol* 14:536–542
12. Nakae S, Suto H, Berry GJ et al (2007) Mast cell-derived TNF can promote Th17 cell-dependent neutrophil recruitment in ovalbumin-challenged OTII mice. *Blood* 109:3640–3648
13. Yang XO, Chang SH, Park H et al (2008) Regulation of inflammatory responses by IL-17 F. *J Exp Med* 205:1063–1075
14. Kearley J, Barker JE, Robinson DS et al (2005) Resolution of airway inflammation and hyperreactivity after in vivo transfer of CD4<sup>+</sup>CD25<sup>+</sup> regulatory T cells is interleukin 10 dependent. *J Exp Med* 202:1539–1547
15. Lewkowich IP, Herman NS, Schleifer KW et al (2005) CD4<sup>+</sup>CD25<sup>+</sup> T cells protect against experimentally induced asthma and alter pulmonary dendritic cell phenotype and function. *J Exp Med* 202:1549–1561
16. Meyer EH, Goya S, Akbari O et al (2006) Glycolipid activation of invariant T cell receptor<sup>+</sup> NK T cells is sufficient to induce airway hyperreactivity independent of conventional CD4<sup>+</sup> T cells. *Proc Natl Acad Sci U S A* 103:2782–2787
17. Wenzel SE (2012) Asthma phenotypes: the evolution from clinical to molecular approaches. *Nat Med* 18:716–725
18. Adcock IM, Lane SJ (2003) Corticosteroid-insensitive asthma: molecular mechanisms. *J Endocrinol* 178:347–355
19. Sorkness RL, Bleecker ER, Busse WW et al (2008) Lung function in adults with stable but severe asthma: air trapping and incomplete reversal of obstruction with bronchodilation. *J Appl Physiol* 104:394–403
20. Takayama G, Arima K, Kanaji T et al (2006) Periostin: a novel component of subepithelial fibrosis of bronchial asthma downstream of IL-4 and IL-13 signals. *J Allergy Clin Immunol* 118:98–104
21. Corren J, Lemanske RF, Hanania NA et al (2011) Lebrikizumab treatment in adults with asthma. *N Engl J Med* 365:1088–1098

---

# Chronic Obstructive Pulmonary Disease (COPD)

Irena Konstantinova and Andrew C. Pearce

---

## Introduction to COPD

Chronic obstructive pulmonary disease (COPD) is a major health burden predicted to become the third most common cause of death and the fifth most common cause of disability worldwide by 2020 [1]. An international population-based COPD study in 2007 identified 10 % prevalence of mild or severe COPD in 12 different countries [2].

COPD is characterized by chronic obstructive bronchiolitis accompanied by fibrosis and emphysema represented by parenchymal destruction, airspace enlargement, loss of lung elasticity, and obstruction of the small airways [3]. In contrast, chronic bronchitis is defined by a productive cough with mucus hypersecretion but not necessarily airflow limitation [4]. Most COPD patients show all three pathological features: bronchiolitis, emphysema (breakdown of lung tissue), and mucus plugging. The obstruction and airflow limitation are progressive, irreversible,

and associated with abnormal inflammation in response to harmful toxic particles and gases, such as tobacco smoke. This is in stark contrast to asthma, where the airflow obstruction is usually reversible (see chapter “Asthma”). Interestingly, COPD patients are resistant to corticosteroid therapy (see below) [4]. This fact illustrates a major difference in the inflammation process between the two diseases and necessitates research into novel therapies.

The disease prevalence is directly related to the prevalence of tobacco smoking. This is the main risk factor for disease development and progression, although outdoor, occupational, and indoor air pollutions are all major risk factors [5]. COPD is a heterogeneous disease, and among people with the same smoking history, not all will develop the disease due to differences in genetic predisposition. The best-documented genetic risk factor is a severe hereditary deficiency of  $\alpha_1$ -antitrypsin, a circulating inhibitor of serine proteases implicated in disease progression (see below) [6].

Characteristic COPD symptoms are chronic dyspnea (shortness of breath), cough or sputum production, wheezing, and chest tightness. Clinical diagnosis requires spirometry measurements based on the forced expiratory volume in one second (FEV1) and classifies patients with COPD into four stages based on severity of symptoms, risk for exacerbations, and existing comorbidities (e.g., nutritional abnormalities, skeletal muscle dysfunction, and cardiovascular defects) [7].

---

I. Konstantinova (✉)  
Biologics Unit, Novartis Institutes for Biomedical Research, Novartis Horsham Research Centre for Respiratory Diseases, Wimbleshurst Road, Horsham, West Sussex RH12 5AB, UK  
e-mail: [irena.konstantinova@novartis.com](mailto:irena.konstantinova@novartis.com)

A.C. Pearce  
Integrated Biology Unit, Novartis Institutes for Biomedical Research, Novartis Horsham Research Centre for Respiratory Diseases, Wimbleshurst Road, Horsham, West Sussex RH12 5AB, UK  
e-mail: [andrew.pearce@novartis.com](mailto:andrew.pearce@novartis.com)



## Pathophysiology of COPD and Metabolic Alterations

Histological COPD examinations show predominant involvement of peripheral airways (bronchioles) and parenchyma (alveoli), while asthma affects all airways but rarely the parenchyma [4]. Narrowing of the small airways, obstruction of the lumen with mucus, and emphysema all contribute to the airflow limitation in COPD (Fig. 1a).

There is clear evidence that chronic inflammation leads to narrowing of the airways and alveolar destruction [4]. Mucus secretion occurs in response to bacteria or irritants (inhaled particles).

The inflammation manifests itself by increased numbers of alveolar macrophages, neutrophils, and cytotoxic T cells (see chapter “[Overview](#)” under the part “Immune system”) and a continuous release of multiple inflammatory mediators – cytokines, chemokines, lipids, and growth factors acting on the airway epithelium. Oxidative stress and imbalance between proteases and antiproteases intensify the inflammation (Fig. 1b) [4].

Macrophages play an essential role in the pathology of COPD (see Fig. 1b). They are activated by tobacco smoke and other harmful stimuli and release tumor necrosis factor- $\alpha$  (TNF- $\alpha$ ), interleukin 8 (IL-8), CXC chemokines, monocyte chemoattractant protein-1, leukotriene B4, proteases, and reactive oxygen species, thus intensifying the inflammation by recruiting even more immune cells and causing further damage to the tissue. The expression of most of these mediators is regulated by the transcription factor nuclear factor- $\kappa$ B (NF- $\kappa$ B), which is activated in the macrophages of COPD patients [4].

Other cell types involved in the pathology of COPD are cytotoxic CD8<sup>+</sup> T cells, eosinophils, dendritic cells, and epithelial cells (see chapter “[Overview](#)” under the part “Immune system” and Fig. 1b). Dendritic cells play a central role in the initiation of the immune response. CD8<sup>+</sup> T cells have been linked to epithelial cell death in addition to their cytokine release function [4]. The role of eosinophils is still uncertain but it seems to be greater in exacerbations [8]. Epithelial cells are an important source of inflammatory mediators, such as TNF- $\alpha$  and IL-8, contributing to the chronic

inflammation, which induces local fibrosis [4]. Airway epithelial cells play an important role in defense against bacteria and inhaled particles by producing mucus and translocating immunoglobulins from blood into the alveolar lumen. Tobacco smoke and other harmful substances interfere with these processes and lead to increased epithelial cell proliferation, mucus secretion, obstruction of the airways, and compromised defense mechanisms [4]. Consequently, COPD patients are more susceptible to bacterial and viral infections as well as environmental pollution [9].

After exposure to tobacco smoke or inhalation of harmful particles, activated immune and epithelial cells in the lung produce high quantities of reactive oxygen species (ROS) such as superoxide anions and the highly reactive hydroxyl radicals. The antioxidant systems cannot counteract this excessive production. Therefore, the ROS damage lipids, proteins, and DNA and potentiate inflammation via various signaling factors (e.g., NF- $\kappa$ B, activator protein 1, and p38 mitogen-activated protein kinase) [10].

Various proteases and antiproteases are involved in the normal turnover of connective tissue components in the lung. Yet, in COPD patients, these are deregulated favoring parenchyma destruction and emphysema. In part, this imbalance is caused by high levels of serine proteases, including neutrophil elastase, cathepsins, and matrix metalloproteinases (MMPs), in response to inflammatory cytokines and oxidative stress, released by an increased number of activated neutrophils. Additionally, these proteases are potent stimulants of epithelial mucus secretion and thus contribute to both alveolar destruction and airway obstruction [4].

Besides pulmonary abnormalities, COPD patients have significant systemic effects (comorbidities), which can present as skeletal muscle dysfunction, osteoporosis (see chapter “[Osteoporosis](#)”), diabetes (see chapter “[Diabetes mellitus](#)”), heart failure (see chapter “[Heart failure](#)”), anemia, or depression (see chapter “[Major depressive disorder](#)”) [7]. The mechanisms for most of these are unclear, but tissue hypoxia and systemic inflammation are likely to contribute to the pathologies.



Molecular links have been established between systemic oxidative stress, protein degradation, muscle and bone atrophy, cardiovascular and neurological comorbidities, and inflammation (e.g.,  $TNF-\alpha$ ,  $IL-6$ , and  $IL-8$ ) [11].

In conclusion, exposure to inhaled toxic agents leads to chronic irreversible inflammation, oxidative stress, and increased numbers of activated macrophages, neutrophils, and cytotoxic T

cells, releasing multiple inflammatory mediators. This leads to further recruitment of immune cells, airway epithelium proliferation, mucus hypersecretion, and airflow limitation. Combination of inflammation, imbalance in the protease-antiprotease system, and local tissue remodeling (fibrosis) results in alveolar wall destruction and emphysema. Based on their compromised lung anatomy and function, COPD patients are more

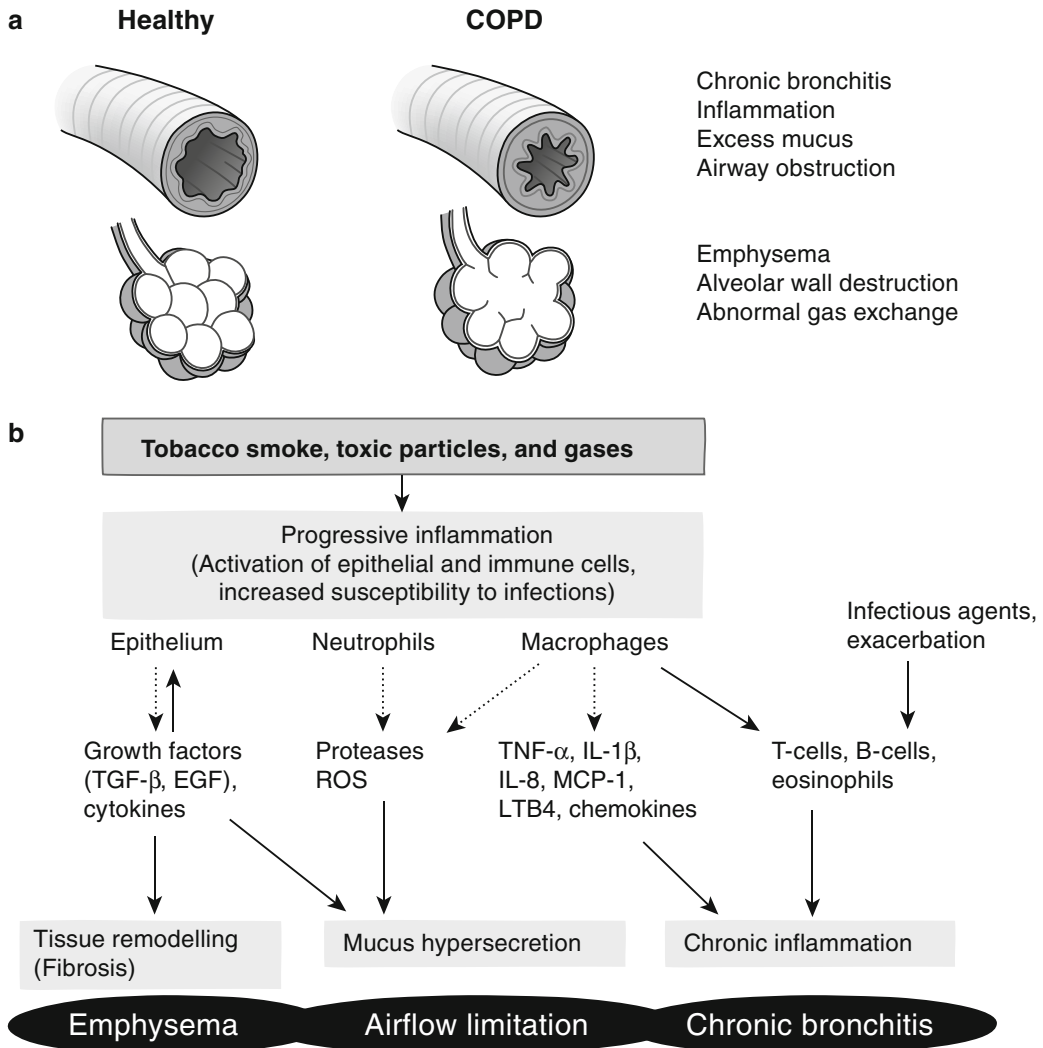

**Fig. 1** Pathological hallmarks and implicated cell types in chronic obstructive pulmonary disease. **(a)** Comparison between healthy and chronic obstructive pulmonary disease (COPD) tissue in the upper (bronchi, above) and smaller airways (alveoli, below) and pathological manifestation of COPD – chronic bronchitis and emphysema,

respectively. **(b)** Cellular components and molecular mechanisms of the inflammation and structural changes in the COPD lung tissue. *TGF-β* transforming growth factor β, *EGF* epidermal growth factor, *ROS* reactive oxygen species, *TNF-α* tumor necrosis factor-α, *IL* interleukin, *MCP-1* monocyte chemoattractant protein-1, *LTB4* leukotriene B4

susceptible to exacerbations and often develop metabolic comorbidities.

## Introduction to Treatment and Influence on Metabolism

COPD treatment aims to reduce the symptoms and exposure to risk factors. None of the existing COPD medical interventions (see Table 1 for the most common examples) has been shown to conclusively modify the long-term decline in lung function [7].

## Smoking Cessation

Smoking cessation is the only therapeutic intervention so far shown to reduce disease progression [12]. However, the main problem with this approach is the nicotine addiction. There are several forms of nicotine replacement therapies, but their effectiveness is very low [13]. Efforts for

more effective approaches continue, e.g., non-nicotinic drugs targeting neurotransmitter systems [14] and acetylcholine receptors [15].

## Long-Acting Bronchodilators

Long-acting  $\beta_2$  agonists (LABA, e.g., formoterol, salmeterol) improve lung function by binding to  $\beta_2$  adrenergic receptor on smooth muscle cells (SMCs) surrounding the airways and inhibiting their contraction. Treatment with LABA leads to reduced symptoms and improved FEV<sub>1</sub>, exercise capacity, and health status [7]. This improvement reflects the increased expiratory flow resulting from widening of the obstructed airways. There are some concerns about side effects of LABA such as cardiac dysrhythmia and increased oxygen consumption, but lower doses are effective and safe [12]. In addition to dilating the airways, LABA have some indirect effects on inflammation leading to decreased neutrophil numbers and IL-8 levels [16].

**Table 1** Summary of the most common COPD treatments, outcomes, and side effects

Treatment	Target	Results	Consequence	Side effects
LABA <i>Formoterol</i> <i>Salmeterol</i>	$\beta_2$ -Adrenergic receptor (SMCs)	Bronchodilation due to inhibition of airway SMC contraction	Improved FEV <sub>1</sub> , exercise capacity, general health status	Cardiac rhythm disturbance, somatic tremor, increased oxygen consumption
LABA <i>Tiotropium bromide</i>	Acetylcholine receptors (SMCs, submucosal gland cells)	Bronchodilation due to inhibition of airway SMC contraction and mucus secretion	Improved FEV <sub>1</sub> , exercise capacity, general health status; reduced exacerbations	Dryness of the mouth
Inhaled corticosteroids <i>Budesonide</i>	Glucocorticoid receptor (multiple cell types)	Minimal effect on lung function	Reduced exacerbations	Oral infections, skin bruising, increased risk of pneumonia
PDE4 inhibition <i>Roflumilast</i>	PDE4 (inflammatory and immune cells)	Reduced inflammation due to inhibition of cAMP hydrolysis	Improved FEV <sub>1</sub> , reduced exacerbations	Nausea, reduced appetite, abdominal pain, diarrhea, headache, sleep disturbance

LABA long-acting  $\beta_2$  agonists, SMC smooth muscle cell, FEV<sub>1</sub> forced expiratory volume in 1 s, PDE4 phosphodiesterase-4

Tiotropium bromide binds to muscarinic acetylcholine receptors on airway SMCs and submucosal gland cells and inhibits contraction and mucus secretion. This bronchodilator effect translates into FEV1 increase and improved exercise capacity and health status [7]. Tiotropium bromide is well tolerated with the only side effect of mouth dryness [7]. There is some evidence that tiotropium bromide is effective in reducing exacerbations, although the mechanism is not well understood [17].

### Corticosteroids

Corticosteroids act by binding to the ubiquitously expressed glucocorticoid receptor, which translocates to the nucleus and represses expression of inflammatory genes or induces expression of anti-inflammatory genes. Eosinophils seem to be the most steroid-responsive immune cells, but in contrast to asthma, they are not prominent in COPD [8]. In addition, alveolar macrophages from COPD patients appear to be steroid resistant [12]. When inhaled, especially in combination with LABA, corticosteroids (e.g., budesonide) have a modest effect on lung function decline and exacerbations. However, prolonged treatment increases the risk of infections (especially pneumonia) and skin bruising [7].

### Phosphodiesterase-4 Inhibitors

Decrease of cellular cAMP levels activates inflammatory cells such as neutrophils, T cells, macrophages, and structural cells such as epithelial cells, SMCs, fibroblasts, mucus gland cells, and sensory neurons [12]. Phosphodiesterase-4 (PDE4) antagonists reduce inflammation by inhibiting PDE4-mediated cAMP hydrolysis. Treatment leads to improved FEV1 in moderate to severe COPD patients [7]. PDE4 inhibitors have several side effects such as nausea, diarrhea, headache, abdominal pain, and sleep distur-

bances probably due to low specificity and high systemic availability. Therefore, more specific PDE4 inhibitors (such as roflumilast [8]) and inhaled approaches to retain the drug in the lung are being currently considered [7].

### Other Therapies

Other therapies include use of antibiotics during exacerbations and oxygen therapy in patients with chronic respiratory failure. There is a branch of COPD therapy based on non-pharmacological approaches including pulmonary rehabilitation (exercise and peripheral muscle training), nutritional supplementation (against weight loss, skeletal muscle waste, and osteoporosis if the respective comorbidities are present), and surgical treatment (lung transplantation or removal of part of the lung in order to increase effectiveness of respiratory muscles) [7].

---

### Perspectives

Further research into the basic cellular, molecular, and genetic abnormalities of COPD is necessary. It is important to identify the genes determining why only some heavy smokers develop significant COPD. This can lead to identification of novel targets and better patient stratification for therapy.

Current research is focused on inflammatory mediator antagonists, e.g., inhibitors of lipids (e.g., leukotriene B4, prostaglandin E2), cytokines (e.g., TNF- $\alpha$ ), and others. Antioxidants are considered as a potentially beneficial therapy. Based on the imbalance of proteases and antiproteases, studies targeting neutrophil elastase, MMPs, and cysteine proteases are ongoing. Finally, there is a growing interest in the potential use of stem cells for repair of the damaged lung tissue [8].

In conclusion, improved COPD therapies are urgently needed to provide long-term benefit in this common and important disease, for which no effective preventive therapy or cure exists.

## References

1. Lopez AD, Murray CC (1998) The global burden of disease, 1990–2020. *Nat Med* 4:1241–1243
2. Buist AS, McBurnie MA, Vollmer WM, Gillespie S, Burney P, Mannino DM, Menezes AM, Sullivan SD, Lee TA, Weiss KB, Jensen RL, Marks GB, Gulsvik A, Nizankowska-Mogilnicka E (2007) International variation in the prevalence of COPD [the BOLD study]: a population-based prevalence study. *Lancet* 370: 741–750
3. Barnes PJ (2000) Chronic obstructive pulmonary disease. *N Engl J Med* 343:269–280
4. Barnes PJ, Shapiro SD, Pauwels RA (2003) Chronic obstructive pulmonary disease: molecular and cellular mechanisms. *Eur Respir J* 22:672–688
5. Lamprecht B, McBurnie MA, Vollmer WM, Gudmundsson G, Welte T, Nizankowska-Mogilnicka E, Studnicka M, Bateman E, Anto JM, Burney P, Mannino DM, Buist SA (2011) COPD in never smokers: results from the population-based burden of obstructive lung disease study. *Chest* 139:752–763
6. Stoller JK, Aboussouan LS (2005) Alpha1-antitrypsin deficiency. *Lancet* 365:2225–2236
7. Vestbo J, Hurd SS, Agustí AG, Jones PW, Vogelmeier C, Anzueto A, Barnes PJ, Fabbri LM, Martinez FJ, Nishimura M, Stockley RA, Sin DD, Rodriguez-Roisin R (2013) Global strategy for diagnosis, management, and prevention of COPD: GOLD executive summary. *Am J Respir Crit Care Med* 187:347–365
8. Saetta M, Di Stefano A, Maestrelli P, Turato G, Ruggieri MP, Roggeri A, Calcagni P, Mapp CE, Ciaccia A, Fabbri LM (1994) Airway eosinophilia in chronic bronchitis during exacerbations. *Am J Respir Crit Care Med* 150:1646–1652
9. Parker CM, Voduc N, Aaron SD, Webb KA, O'Donnell DE (2005) Physiological changes during symptom recovery from moderate exacerbations of COPD. *Eur Respir J* 26:420–428
10. MacNee W (2001) Oxidative stress and lung inflammation in airways disease. *Eur J Pharmacol* 429:195–207
11. Barnes PJ, Celli BR (2009) Systemic manifestations and comorbidities of COPD. *Eur Respir J* 33:1165–1185
12. Barnes PJ, Stockley RA (2005) COPD: current therapeutic interventions and future approaches. *Eur Respir J* 25:1084–1106
13. Wagena EJ, van der Meer RM, Ostelo RJ, Jacobs JE, van Schayck CP (2004) The efficacy of smoking cessation strategies in people with chronic obstructive pulmonary disease: results from a systematic review. *Respir Med* 98:805–815
14. Cryan JF, Gasparini F, Van Heeke G, Markou A (2003) Non-nicotinic neuropharmacological strategies for nicotine dependence: beyond bupropion. *Drug Discov Today* 8:1025–1034
15. Dani JA (2003) Roles of dopamine signaling in nicotine addiction. *Mol Psychiatry* 8:255–256
16. Sovani MP, Whale CI, Tattersfield AE (2004) A benefit-risk assessment of inhaled long-acting beta2-agonists in the management of obstructive pulmonary disease. *Drug Saf* 27:689–715
17. Casaburi R, Mahler DA, Jones PW, Wanner A, San PG, ZuWallack RL, Menjoge SS, Serby CW, Witek T Jr (2002) A long-term evaluation of once-daily inhaled tiotropium in chronic obstructive pulmonary disease. *Eur Respir J* 19:217–224

---

# Community-Acquired Pneumonia

Salvador Sialer, Leonardo F. Difrancesco, Teresa Foix Fabregas, and Antoni Torres

---

## Introduction to Community-Acquired Pneumonia

Community-acquired pneumonia (CAP) is a leading cause of morbidity and mortality in the world, with an annual incidence ranking from 1.6 to 10.6 per 1,000 people in Europe. The incidence is age related, peaking over 65 years. Up to 75 % of CAP patients with pulmonary diseases need hospitalization, and up to a 10 % of these are admitted to an intensive care unit (ICU) due to complications like sepsis, septic shock, and acute respiratory distress syndrome (ARDS) [1–3]. Up to 8 % of CAP patients die within 90 days of disease onset; 21 % die within a year [4] making CAP the most frequent cause of death from infection in Europe and the third most common cause of death in general [5]. Mortality is highest in ICU patients.

CAP is usually associated with fever, productive cough, hemoptysis (cough containing blood), dyspnea (shortness of breath), and pleuritic and chest pain with a consolidation on the chest X-ray. Many factors influence the clinical presentation of pneumonia including pathogen virulence and age as well as some risk factors like chronic obstructive pulmonary disease (COPD; see chapter “COPD”), diabetes (see chapter “Diabetes mellitus”), alcoholism, smoking, malnutrition, immunodeficiency, and cardiovascular and renal comorbidities [6, 7].

CAP can be caused by (i) typical pathogens (such as *Streptococcus pneumoniae*, *Haemophilus influenzae*), (ii) atypical pathogens (such as *Legionella pneumophila*, *Mycoplasma pneumoniae*, and *Chlamydia pneumoniae*), and (iii) viruses (such as adenovirus, respiratory syncytial virus, and human parainfluenza virus). A mixed etiology accounts for 10–20 % of causes (typical plus atypical) [8, 9].

Valid sputum can be collected from about 40 % of patients and the Gram stain allows diagnosis in 80 % of patients [10]. The Infectious Diseases Society of America guidelines recommend that the sputum specimen must be obtained before the initiation of antibiotic therapy in inpatients. Additionally, blood culture testing is recommended in all patients with severe CAP, showing cavitory infiltrates, leukopenia (decreased numbers of leukocytes), alcohol abuse, chronic severe liver disease, or asplenia (disturbed spleen function). Bronchoalveolar lavage to obtain fluid from a small part of the lung via bronchoscopy is

---

S. Sialer • T.F. Fabregas • A. Torres (✉)  
Servei de Pneumologia, Hospital Clínic,  
Universitat de Barcelona,  
Villarroel 170, 08036 Barcelona, Spain

Institut d'Investigacions Biomèdiques August Pi i  
Sunyer (IDIBAPS), University of Barcelona,  
CIBERES, C/Roselló 149-153,  
08036 Barcelona, Spain  
e-mail: [stsialer@clinic.ub.es](mailto:stsialer@clinic.ub.es);  
[teresadala@hotmail.es](mailto:teresadala@hotmail.es); [atorres@ub.edu](mailto:atorres@ub.edu)

L.F. Difrancesco  
Internal Medicine Department,  
Sant'Andrea Hospital, Sapienza University,  
Via di Grottarossa, 1035/39, 00189 Roma, Italy  
e-mail: [difrancesco.leonardo@uniroma1.it](mailto:difrancesco.leonardo@uniroma1.it)

suitable for patients with life-threatening CAP or worsening pneumonia despite antimicrobial therapy. Urinary antigen determination may detect *Legionella pneumophila* and *S. pneumoniae*. Serum biomarkers like C-reactive protein (CRP) and procalcitonin (PCT) may be used as indicators of bacterial infection [11–13].

## Pathophysiology of Community-Acquired Pneumonia

The pathophysiology of CAP involves both host defense and microbial virulence factors. Constant exposure to contaminated air and frequent aspiration of nasopharyngeal flora make lung parenchyma susceptible to virulent microorganisms, commonly reaching the lower respiratory tract as inhaled and contaminated microdroplets. Mucociliary clearance and cough reflex are important initial defenses against infection and can be inhibited by neurologic diseases and conditions that impair the mucociliary mechanism [6, 8].

Most CAPs are bacterial in origin and often follow brief viral upper respiratory tract infection. There are two main mechanisms to acquire pneumonia. Firstly, inhalation causes pneumonia due to microorganisms that can remain suspended in air and evade local host defenses. In addition, aerosolization is the route of infection by intracellular bacteria such as *Mycoplasma pneumoniae*, *Chlamydophila* spp., *Coxiella burnetii*, and *Legionella pneumophila* [6, 8, 9]. Secondly, aspiration of oropharyngeal flora can cause CAP. The ability of virulent bacteria such as *Streptococcus pneumoniae*, *Staphylococcus aureus*, *Pseudomonas aeruginosa*, and *Klebsiella pneumoniae* to colonize the oropharynx is determined by the interaction of specific microbial adhesins with cellular receptors. For example, components of the extracellular matrix (ECM) such as fibronectin in oral mucus promote the adherence of *viridans streptococci*. In contrast, salivary fibronectin prevents colonization by Gram-negative bacilli, and decreased levels of fibronectin due to alcoholism, diabetes, malnutrition, and other severe comorbidities might

contribute to an increased CAP risk. The presence of local immunoglobulins, particularly immunoglobulin A (IgA), complement, and normal flora also prevents colonization of the oropharynx by virulent organisms [6, 8, 9].

Patients with pneumonia frequently show moderate to severe arterial hypoxemia (an abnormally low O<sub>2</sub> level in arterial blood), probably due to pulmonary shunts (i.e., when ventilation fails to supply O<sub>2</sub> to alveoli that receive normal blood perfusion, which happens, e.g., when alveoli are filled with fluid), increased whole-body O<sub>2</sub> uptake, ventilation-perfusion (V<sub>A</sub>/Q) mismatching, and/or limited alveolar O<sub>2</sub> diffusion into the blood [14].

Previous studies in animal models of pneumonia [15] and in humans [16] have demonstrated that the most common pattern of V<sub>A</sub>/Q mismatching is a combination of both intrapulmonary shunt and mild to moderate areas of low ventilation-perfusion (V<sub>A</sub>/Q) ratios. Pulmonary hypoxia (i.e., low O<sub>2</sub> levels in the lung) causes vasoconstriction to avoid perfusion of non-ventilated alveoli and redistribution of the blood flow to better-ventilated lung areas. This response is often blunted in CAP patients (causing intrapulmonary increased shunts and decreased V<sub>A</sub>/Q ratios) due to local release of vasodilatory prostacyclins.

Prolonged systemic inflammation and bacterial translocation to the blood cause sepsis (see chapter “Sepsis”), a common consequence of CAP. Impaired tissue oxygenation, as commonly occurs in CAP, is a major mechanism of organ failure in sepsis [17, 18].

The host response to sepsis is characterized by both pro- and anti-inflammatory responses (see also chapter “Overview” under the part “Immune system”). The extent and duration of these reactions are determined by host factors (age, comorbidities, medications, and genetic characteristics) and pathogen factors (microbial load and virulence) [17, 19]. Proinflammatory reactions directed at eliminating invading pathogens are thought to be responsible for collateral tissue damage. In contrast, anti-inflammatory responses are important to limit tissue injury, yet enhance susceptibility to secondary infections.

## Treatment of Community-Acquired Pneumonia

CAP treatment is still largely empirical because of the difficulties to detect the infective pathogen(s) from lung samples and should follow an approach according to the individual risk of mortality [6, 9]. Although the most common bacterium identified in CAP patients is *S. pneumoniae*, other microorganisms (see above) are frequently involved, dependent on the place of care (see Table 1).

Eradication of the causative microorganism is the most common and effective treatment option, and thus, antibiotic treatment should be initiated as soon as possible after diagnosis. In patients with CAP and septic shock, delay must not be more than 1 h after diagnosis [6, 11, 20]. The severity of the disease implies a decision about the most appropriate treatment setting (ambulatory, hospital ward, or ICU) and antibiotic used according to European guidelines [20].

In a responding patient, the duration of treatment should generally not exceed 8 days, because longer treatment days may increase bacterial resistance. The serial use of serum biomarkers, particularly PCT, may guide even shorter treatment duration, because PCT levels correspond to response to treatment.

Multidrug resistance (MDR) represents an emerging problem in CAP because of the increasing number of residents living in health-care facilities [21]. The empirical treatment of health-care-acquired pneumonia (HCAP) is still controversial. The current trend is to use risk factors to suggest MDR or “different to treat pathogens” as *P. aeruginosa*, *S. aureus* MR, or *Enterobacteriaceae* [22, 23].

Recently, it has been proposed that the use of aerosolized vasodilators may benefit patients. Inhaled nitric oxide (NO) has been shown to improve pulmonary gas exchange in patients with acute respiratory distress syndrome (ARDS) due to vasodilatation in ventilated lung areas where exogenous NO has easy access. As a result, blood flow is redistributed from non-ventilated to ventilated alveolar units, thereby reducing intrapulmonary shunts. Inhaled low doses of NO thus

**Table 1** Frequency of common microorganisms causing community-acquired pneumonia in different treatment settings

Microorganism	Outpatient %	Hospital %	ICU %
<i>Streptococcus pneumoniae</i>	35	43	42
Atypical bacteria	36	16	14
<i>Mycoplasma pneumoniae</i>	17	3	2
<i>Coxiella burnetii</i>	7	2	1
<i>Legionella pneumophila</i>	6	8	8
<i>Chlamydomphila pneumoniae</i>	6	3	3
Respiratory virus	9	12	10
<i>Haemophilus influenzae</i>	5	5	3
Enteric Gram-negative bacilli	1	2	1
<i>Staphylococcus aureus</i>	1	2	2
<i>Pseudomonas aeruginosa</i>	1	4	5
Polymicrobial	9	13	22
Others	4	3	6

ICU intensive care unit

improve arterial oxygenation allowing to gain time for the effect of antibiotics [24].

## Influence of Treatment on Metabolism and Consequences for Patients

Although the inflammatory response in CAP is compartmentalized to the lung, most cytokines can be detected in the systemic circulation, such as interleukin (IL)-6, interleukin-8, and interleukin-10 and tumor necrosis factor- $\alpha$  (TNF- $\alpha$ ). However, they decline in the first 48 h of treatment (except TNF- $\alpha$ ) [25], correlating with the time to clinical defervescence (i.e., departure of fever).

High levels on admission of IL-6 as well as levels of IL-6 and IL-8 in the first 48 h were significantly higher in patients requiring ICU admission and those who died [26]. CAP patients with pneumococcal infection receiving combination therapy, a  $\beta$ -lactam antibiotic plus a fluoroquinolone antibiotic (e.g., a cephalosporin plus levofloxacin; see Table 2), show a faster decrease in IL-6 [25, 26], recommending this treatment option.



**Table 2** Treatment options for community-acquired pneumonia

Place of care	Empirical antibiotic
Ambulatory	Amoxicillin or amoxicillin-clavulanate ± macrolide Levofloxacin or moxifloxacin
Hospital ward	Aminopenicillin ± macrolide Aminopenicillin/β-lactamase inhibitor ± macrolide Non-antipseudomonal cephalosporin Cefotaxime or ceftriaxone ± macrolide Levofloxacin Moxifloxacin Penicillin G ± macrolide
ICU/intermediate care	<i>No risk factors for P. aeruginosa</i> Non-antipseudomonal cephalosporin III + macrolide Moxifloxacin ± non-antipseudomonal cephalosporin III Levofloxacin ± non-antipseudomonal cephalosporin III <i>Risk factors for P. aeruginosa</i> Antipseudomonal cephalosporin PLUS ciprofloxacin Acylureidopenicillin/β-lactamase inhibitor PLUS Macrolide + Aminoglycoside (Gentamicin, Tobramycin, or Amikacin) Carbapenem PLUS Macrolide + Aminoglycoside (Gentamicin, Tobramycin, or Amikacin)

ICU intensive care unit

Mortality in hospitalized pneumonia patients is often associated with cardiac complications such as cardiac insufficiency, arrhythmias, and myocardial infarction [27]. The reasons for this are still unclear, but could be explained by the persistent residual inflammation found in these patients.

Additional therapies used in patients with CAP include adjunctive corticosteroids, low molecular weight heparin (LMWH), the use of noninvasive ventilation (NIV), and statin drugs [20].

Corticosteroids are powerful inhibitors of inflammation, reducing the levels of TNF-α, IL-1β, IL-8, and IL-6 and thus recruitment of inflammatory cells into the alveolar space. Additionally, they can ameliorate the insufficient adrenal response in patients with severe CAP and septic shock [4, 6, 20].

LMWH should be given to patients with acute respiratory failure in order to inhibit coagulation (see chapter “Overview” under the part “Blood”), a major pathophysiological event in severe CAP. LMWH are used as prophylactic means to prevent pulmonary thromboembolism [20].

The use of NIV (meaning ventilatory support through the patient’s upper airway using a mask or similar device) is not yet the standard care, but

often used in patients with COPD to treat acute hypercapnic respiratory failure (meaning the failure to eliminate CO<sub>2</sub> properly) [6, 20].

Statins have pleiotropic effects (see chapter 43) showing immunomodulatory, anti-inflammatory, antithrombotic, and direct antimicrobial action. Interestingly, patients receiving statins at the time of CAP onset were less likely to develop sepsis and associated mortality. The beneficial effect of statins in CAP patients might also be attributed to their prevention of acute coronary syndrome and myocardial infarction, which are common in CAP, yet further research on their mode of action is needed.

## Perspectives

Although mortality of hospitalized CAP has decreased in recent years, further improvement is required, especially in the area of clinical practice and pathophysiological research. To reduce hospital mortality, a system to quickly detect CAP, evaluate its severity, and identify infectious microbes is required for quick intervention and administration of adequate antibiotics. This is of particular importance in MDR pathogens



that already represent 6–10 % of cases of CAP. Measurement of biomarkers, such as PCT and pro-adrenomedullin, will be crucial to determine severity and prognosis as well as to monitor treatment.

Research into the relationship between inflammation and cardiac complications in CAP will allow to set up appropriate therapeutic strategies to decrease mortality and complications of CAP. Finally, better and careful follow-up of CAP patients after discharge will reduce long-term mortality.

## References

- Almirall J, Bolibar I, Vidal J et al (2000) Epidemiology of community acquired pneumonia in adults: a population-based study. *Eur Respir J* 15:757–763
- Ewig S, Birkner N, Strauss R et al (2009) New perspectives on community-acquired pneumonia in 388406 patients. Results from a nationwide mandatory performance measurement program in healthcare quality. *Thorax* 64:1062–1069
- Zalacain R, Torres A, Celis R et al (2003) Community-acquired pneumonia in the elderly: Spanish multicentre study. *Eur Respir J* 21:294–302
- Nair GB, Niederman MS (2011) Community acquired pneumonia: an unfinished battle. *Med Clin North Am* 95:1143–1161
- Gibson GJ, Lodenkemper R, Lundbäck B et al (2013) Respiratory health and disease in Europe: the new European Lung White Book. *Eur Respir J* 42(3):559–563
- Torres A, Barberán J, Falguera M et al (2013) Multidisciplinary guidelines for the management of community-acquired pneumonia. *Med Clin (Barc)* 140(5):223e.1–223.e.19
- Almirall J, Bolibar I, Serra-Prat M et al (2008) Community-Acquired Pneumonia in Catalan Countries (PACAP) Study Group. New evidence of risk factors for community-acquired pneumonia: a population -based study. *Eur Respir J* 31(6): 1274–1284
- Cillóniz C, Ewig S, Polverino E et al (2012) Community-acquired pneumonia in outpatients: aetiology and outcomes. *Eur Respir J* 40(4):931–938
- Cillóniz C, Ewig S, Polverino E et al (2011) Microbial aetiology of community-acquired pneumonia and its relation to severity. *Thorax* 66:340–346
- Anevlavis S, Petroglou N, Tzavaras A et al (2009) A prospective study of the diagnostic utility of Sputum Gram stain in pneumonia. *J Infect* 59:83–89
- Mandell LA, Wunderink RG, Anzueto A et al (2007) Infectious Diseases Society of America/American Thoracic Society consensus guidelines on the management of community-acquired pneumonia in adults. *Clin Infect Dis* 44(Suppl 2):S27–S72
- Rello J, Bodi M, Mariscal D et al (2003) Microbiological testing and outcome of patients with severe community-acquired pneumonia. *Chest* 123:174–180
- Woodhead M (2011) New guidelines for the management of adult lower respiratory tract infections. *Eur Respir J* 38(6):1250–1251
- Rodriguez-Roisin R, Roca J (1996) Update '96 on pulmonary gas exchange pathophysiology in pneumonia. *Semin Respir Infect* 11(1):3–12
- Light RB, Mink SN, Wood LD (1981) Pathophysiology of gas exchange and pulmonary perfusion in pneumococcal lobar pneumonia in dogs. *J Appl Physiol Respir Environ Exerc Physiol* 50(3):524–530
- Gea J, Roca J, Torres A et al (1991) Mechanisms of abnormal gas exchange in patients with pneumonia. *Anesthesiology* 75(5):782–789
- Angus DC, van der Poll T (2013) Severe sepsis and septic shock. *N Engl J Med* 369(9):840–851
- Khadori R, Castillo D (2012) Endocrine and metabolic changes during sepsis: an update. *Med Clin North Am* 96(6):1095–1105
- Hotchkiss RS, Karl IE (2003) The pathophysiology and treatment of sepsis. *N Engl J Med* 348(2):138–150
- Woodhead M, Blasi F, Ewig S, et al Joint Taskforce of the European Respiratory Society and European Society for Clinical Microbiology and Infectious Diseases (2011) Guidelines for the management of adult lower respiratory tract infections. *Clin Microbiol Infect* 17(Suppl 6):E1–59
- Rubinstein E, Kollef MH, Nathwani D (2008) Pneumonia caused by methicillin-resistant *Staphylococcus aureus*. *Clin Infect Dis* 46(Suppl 5): S378–S385
- Ewig S, Welte T, Torres A (2012) Is healthcare-associated pneumonia a distinct entity needing specific therapy? *Curr Opin Infect Dis* 25(2):166–175
- Ewig S, Torres A (2011) Healthcare-associated pneumonia: meeting the yeti. *Eur Respir J* 38(4):755–757
- Gómez FP, Amado VM, Roca J et al (2013) Effect of nitric oxide inhalation on gas exchange in acute severe pneumonia. *Respir Physiol Neurobiol* 187(2): 157–163
- Fernández-Serrano S, Dorca J, Coromines M et al (2003) Molecular inflammatory responses measured in blood of patients with severe community-acquired pneumonia. *Clin Diagn Lab Immunol* 10(5):813–820
- Padrones S, Garcia-Vidal C, Fernández-Serrano S et al (2010) Impact of antibiotic therapy on systemic cytokine expression in pneumococcal pneumonia. *Eur J Clin Microbiol Infect Dis* 29(10):1243–1251
- Corrales-Medina VF, Musher DM, Wells GA et al (2012) Cardiac complications in patients with community-acquired pneumonia: incidence, timing, risk factors, and association with short-term mortality. *Circulation* 125(6):773–781

---

**Part X**

**Heart**

---

# Overview

Axel Gödecke

---

## Anatomy and Physiology of the Heart

The circulatory system, consisting of the heart and arterial, venous, and capillary blood vessels, delivers oxygen and nutrients to all organs and transports metabolites to sites of further metabolism and excretion. To execute this central role, the heart continuously pumps the blood through the vasculature (see chapter “Overview” under part “Blood vessels”). Although the heart is a single organ, in terms of function, it represents two pumps working in series. Whereas the left heart generates high pressure (basal level 120 mmHg) to supply all organs (except the lung) with oxygenated blood, the right heart enables blood flow through the pulmonary vasculature by generating a low-pressure gradient (basal level 20 mmHg). Left and right hearts show a similar gross anatomy: both consist of an atrium and a ventricle, which are separated by a septum. Due to the differences in workload, the muscle mass of the left ventricle exceeds that of the right one. To achieve a directed blood flow, inlet valves (i.e., mitral and tricuspid valves) separate the atria from the ventricles, and outlet valves (aortic

and pulmonary valves) separate the ventricles from the aorta and pulmonary artery (Fig. 1).

The cardiac cycle is subdivided into two major parts: During systole, the walls of the blood-filled ventricles rapidly contract, resulting in a steep rise of left ventricular pressure. Since the aortic and mitral valves of the left ventricle are closed at the beginning of systole, the first phase represents an isovolumic contraction. However, when left ventricular pressure exceeds that in the aortic root, the aortic valve opens and the blood is pumped into the aorta. At the beginning of the ejection phase blood pressure still rises but begins to decline when the majority of the blood has left the ventricle. As soon as the left ventricular pressure drops below the aortic pressure, the aortic valve will be closed. This event demarcates the end of the systole and the beginning of diastole. The diastolic phase begins with a rapid isovolumic relaxation leading to a drop of left ventricular pressure below the atrial pressure. In consequence, the mitral valve opens for filling of the left ventricle. The early phase of filling is a passive event; the later phase, however, is mediated by atrial contraction.

## Cellular Composition

On a cellular scale, cardiac myocytes (CMs), interstitial fibroblasts, and capillary endothelial cells represent the major cell fractions of the heart (Fig. 1). Moreover, the coronary arteries and veins contribute smooth muscle and endothelial cells to the cardiac cell pool.

---

A. Gödecke  
Heinrich-Heine-Universität Düsseldorf,  
Institut für Herz- und Kreislaufphysiologie,  
Building 22.03., Floor 00, Universitätsstr. 1,  
Düsseldorf 40225, Germany  
e-mail: [axel.goedecke@uni-duesseldorf.de](mailto:axel.goedecke@uni-duesseldorf.de)

**Fig. 1** Anatomic features of the human heart

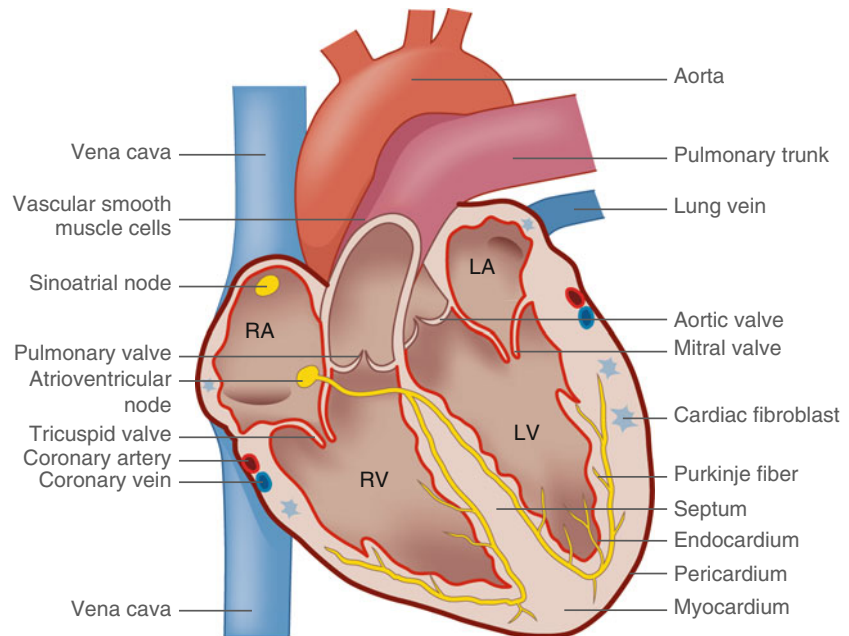

CMs represent the major cell type in terms of mass and dominate the structure of the myocardium. CMs show a characteristic striated pattern similar to skeletal muscle, which is due to the parallel organization of the contractile actin and myosin filaments. At their ends, CMs are connected via intercalated discs. These structures are rich in gap junctions, which allow the spreading of the electric excitation over the myocardium due to a direct electric coupling of CMs. A highly coordinated sequence of temporal and spatial excitation and contraction of CMs leads to a continued cycle of ventricular contraction and relaxation of the whole heart.

Interstitial and perivascular fibroblasts account for two thirds of cardiac cells in terms of numbers [1]. Cardiac fibroblasts synthesize the extracellular matrix, which provides an extracellular protein scaffold for the attachment of CMs, fibroblasts, and endothelial cells. The amount and composition of the cardiac extracellular matrix are important determinants of myocardial stiffness. Therefore, activation of cardiac fibroblasts and enhanced matrix deposition which occur during aging but also in the context of heart failure (see chapter “[Heart failure](#)”) may lead to a reduced ventricular compliance, which impedes diastolic filling.

Endothelial cells also form the inner cell layer of the cardiac chambers termed endocardium. Finally, the heart is surrounded by the pericardium, protecting this vital organ.

The heart is supplied by its own circulatory system, which originates at the aortic root in the form of two main coronary arteries. Since the heart critically depends on aerobic metabolism, there is an extraordinary high capillary density within the myocardium [2].

## Cardiac Muscle Contraction

The heartbeat is the consequence of a well-defined temporal and spatial sequence of excitation and contraction of the cardiac muscle. The origin of the electric excitation is the sinoatrial node (SA node), which consists of specialized CMs able to depolarize spontaneously and autonomously. The SA node represents the primary pacemaker of the heart, and upon its depolarization, a wave of depolarization spreads over the atria. The atrioventricular plane which is assembled by the heart valves insulates the ventricles from the atria. The only conducting connection is the atrioventricular node (AV node), which is

located in the right atrial septum. The atrial excitation passes the AV node and is then conducted to all regions of the ventricular walls by the specialized CMs forming the conduction system including the bundle of His, branches of Tawara, and the Purkinje fibers. The final step of ventricular excitation involves the conduction between CMs via gap junctions.

Due to an unstable resting potential, SA nodal cells depolarize spontaneously, and the SA node is able to initiate cardiac excitation autonomously. However, the slope of this diastolic depolarization is increased by noradrenaline released by sympathetic nerve fibers, which elevates heart rate (positive chronotropy). Acetylcholine, the parasympathetic transmitter, reduces heart rate by flattening the slope of diastolic depolarization. By similar mechanisms, sympathetic innervation of the AV node increases the AV conduction time (positive dromotropy) whereas acetylcholine decreases it (negative dromotropy).

---

### Heart-Specific Metabolic/Molecular Pathways and Processes

With more than three billion contractions, the heart pumps more than 200 million l of blood through the vasculature during a normal human life span. In order to continuously perform its function, the heart critically depends on oxidative phosphorylation. Therefore, delivery of oxygen via coronary perfusion must tightly match cardiac oxygen demands even under high workload. As cardiac muscle contains only around 5  $\mu\text{mol ATP/g}$  wet weight, all ATP would be consumed within 10 s if oxidative ATP generation was stopped.

Almost 95 % of cardiac ATP generation occurs through oxidative phosphorylation, which represents the most efficient way to generate ATP. This high level of oxidative phosphorylation is reflected by a high mitochondrial content (30–35 Vol %) in the CMs. Glycolysis produces most of the residual ATP (<5 %).

Most ATP (60–70 %) is spent in CMs to generate mechanical work driving the circulation. Another large part (30–40 %) is required to run ion pumps (mostly sarco-/endoplasmic reticulum

$\text{Ca}^{2+}$ -ATPase), which in a concerted manner generate the  $\text{Ca}^{2+}$  transients [3]. The periodic release and reuptake of  $\text{Ca}^{2+}$  are required for electromechanical coupling, linking cardiac action potentials with contraction. When the membrane potential of a CM reaches the threshold ( $-70$  mV), opening of voltage-gated sodium channels depolarizes the membrane potential to  $+30$  mV followed by the opening of L-type  $\text{Ca}^{2+}$  channels which mediate an influx of  $\text{Ca}^{2+}$  from the interstitial space. This  $\text{Ca}^{2+}$  current serves dual functions. First, it leads to a long-lasting (200–400 ms) depolarization at a voltage around 0 mV before  $\text{K}^{+}$  conductivity reverses the membrane potential back to the diastolic values ( $-90$  mV). Second, the  $\text{Ca}^{2+}$  influx gives rise to further  $\text{Ca}^{2+}$  release from intracellular stores by opening the ryanodine channel (Ryr2) in the membrane of the sarcoplasmic reticulum (SR). Finally, the intracellular  $\text{Ca}^{2+}$  concentration increases to  $10^{-5}$  mol/l (from initially  $10^{-7}$  mol/l). Subsequent  $\text{Ca}^{2+}$  binding to troponin C displaces tropomyosin from actin, enabling myosin to bind and to perform contraction. This is terminated by  $\text{Ca}^{2+}$  reuptake into the SR and via export by the sarcolemmal  $\text{Na}^{+}/\text{Ca}^{2+}$  exchanger.

Sympathetic nerve fibers also innervate the myocardium. Norepinephrine increases  $\text{Ca}^{2+}$  influx, release from the SR, and accelerates reuptake into the SR leading to faster and increased  $\text{Ca}^{2+}$  transients, which are the basis for enhanced contractile force (positive inotropy).

As only a minor part of the ATP is required for basal biochemical reactions, an experimentally arrested heart consumes only 10 % of the oxygen required to run a working heart. The high demand for ATP of a beating heart even under resting conditions results in a high degree of oxygen demand. The heart consumes 10 % of the whole-body oxygen, although it contributes only 0.5 % to whole-body mass. The high rate of oxygen consumption leads to low  $\text{PO}_2$  values in cardiac tissues. The resultant steep  $\text{O}_2$  gradient toward the capillaries favors oxygen release from hemoglobin and results in a high oxygen extraction (60–70 %) from the perfused blood already under basal conditions. Thus, the elevated oxygen demand under conditions of high workload can

be covered only to a small part by an increase in oxygen extraction (+20 %). Instead, an increase in coronary flow (up to fivefold) largely ensures cardiac oxygen supply to sustain the oxidative generation of ATP.

### Cardiac Substrate Metabolism

Cardiac substrate metabolism occurs in two major variants: The fetal heart depends to a large extent on glucose, whereas the adult heart prefers to consume fatty acids rather than glucose. However, the heart is also able to metabolize lactate and ketone bodies. Therefore, the adult heart has often been named a “metabolic omnivore.” All substrates may finally drain into the citric acid cycle that is fueled by acetyl-CoA derived from glycolysis (glucose),  $\beta$ -oxidation (fatty acids), lactate oxidation, and ketone bodies. Interestingly, in heart failure (see chapter “[Heart failure](#)”), the adult heart may reduce fatty acid oxidation in favor of glucose (termed metabolic remodeling) [4].

Fatty acids account for 50–70 % of total cardiac energy supply in adults. Fatty acid uptake into CMs is mediated to a large extent by fatty acid translocase (FAT/CD36). This protein is in part localized in storage vesicles in CMs, which may fuse with the sarcolemma to enhance uptake of fatty acids (Fig. 2). Important stimuli of membrane translocation are an increase in cardiac workload (contraction-mediated translocation) and insulin. Fatty acids are further oxidized in the mitochondria during  $\beta$ -oxidation yielding high amounts of  $\text{NADH} + \text{H}^+$ ,  $\text{FADH}_2$ , and  $\text{CO}_2$ . Transport of acyl-CoA into the mitochondrion involves the carnitine shuttle system (Fig. 2).

Glucose uptake by CMs may be stimulated under anabolic conditions by insulin via Akt (also called protein kinase B) and under catabolic conditions by the AMP-dependent protein kinase. Both stimulate translocation of the glucose transporter 4 (GLUT4) to the sarcolemma, enhancing glucose uptake (Fig. 2). In part, glucose is used to synthesize glycogen, which serves as an energy store. Upon energy depletion and activation of AMP-dependent protein kinase, glucose is

rapidly mobilized by breakdown of glycogen [5]. Independent of its origin, most glucose enters the glycolytic pathway, leading to the formation of pyruvate.

Lactate also contributes to cardiac ATP generation. It is taken up by the monocarboxylate transporter and converted to pyruvate by the lactate dehydrogenase reaction yielding  $\text{NADH} + \text{H}^+$ . The latter enters the respiratory chain, whereas pyruvate is oxidized to acetyl-CoA. Even under conditions of elevated workload, the heart rather consumes than generates lactate. Thus, during exercise, the heart may use lactate produced by anaerobic glycolysis in skeletal muscle.

---

### Inside-In: Metabolites of the Heart Affecting Itself

A hallmark of cardiac metabolism is the ability to switch between carbohydrates and fatty acids as preferred carbon sources (metabolic flexibility). Under conditions when oxygen is short, the heart uses more “oxygen-rich” glucose, which results in a higher P/O ratio (ATP per oxygen) than the use of the “oxygen-poor” fatty acids.

An important pathway is the Randle cycle [6, 7], also termed the glucose–fatty acid cycle, which is substantially involved in regulating the relative contribution of fatty acid vs. carbohydrate utilization by the heart. Pyruvate, acetyl-CoA, malonyl-CoA, and citrate are important metabolic intermediates, which modulate substrate utilization (Fig. 2).

Fatty acid oxidation increases the mitochondrial acetyl-CoA/CoA and  $\text{NADH}/\text{NAD}^+$  ratios. These changes inhibit pyruvate dehydrogenase (PDH), which determines the oxidation of the glycolytic pyruvate to acetyl-CoA. The activity of PDH is controlled by PDH kinases and PDH phosphatases (Fig. 2). In addition, citrate, leaving mitochondria via citrate carriers, inhibits phosphofructokinases 1 and 2 and therefore reduces glycolysis. However, cytoplasmic citrate can also be converted to acetyl-CoA (and oxaloacetate), which is further converted to malonyl-CoA. Malonyl-CoA inhibits the carnitine shuttle system and thereby long-chain fatty acid uptake by mitochondria.

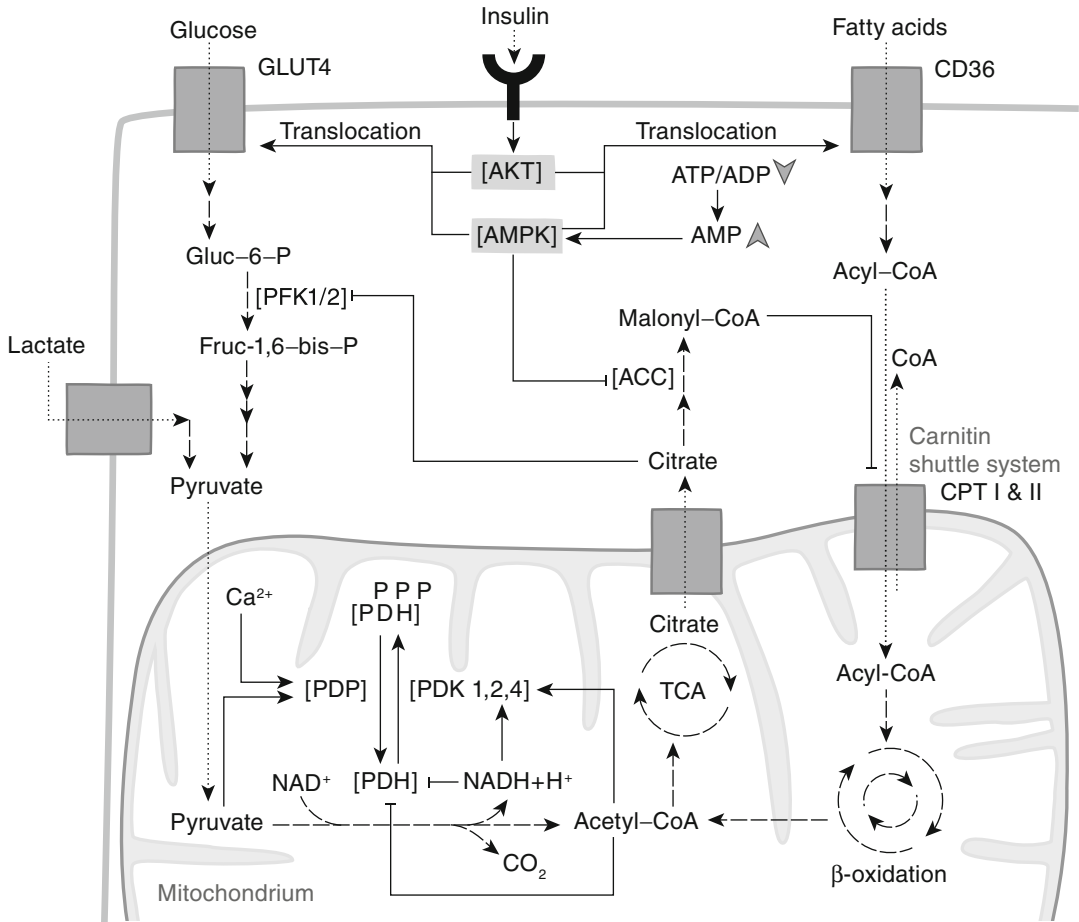

**Fig. 2** Regulation of glucose and fatty acid metabolism in the heart. The basic principle of the glucose fatty acid cycle and its modulation by insulin and low energy is shown. A low ATP/ADP ratio leads to formation of AMP, which activates AMP-dependent protein kinase (AMPK). Insulin activates protein kinase B (AKT) via the insulin receptor. AKT and AMPK induce translocation of the glucose transporter 4 (GLUT4) and the long-chain fatty acid translocase (CD36) to the plasma membrane. Glucose is metabolized in glycolysis (left) to pyruvate, which is subsequently oxidized to acetyl-CoA by pyruvate dehydrogenase (PDH) in the mitochondrion. PDH underlies product inhibition by acetyl-CoA and NADH+H<sup>+</sup> from the β-oxidation. Additionally, they stimulate specific PDH kinases (PDKs), which inhibit PDH by phosphorylation. PDH phosphatase (PDP) dephosphorylates and thus activates PDH. PDP is activated by pyruvate and Ca<sup>2+</sup>, linking

mean elevated cytoplasmic Ca<sup>2+</sup> under β-adrenergic stimulation to elevated glucose oxidation. Lactate is also converted to pyruvate. Fatty acids are converted to acyl-CoA and transported to the mitochondrion via the carnitine shuttle system consisting of carnitine palmitoyltransferase (CPT) I and II, in the outer and inner mitochondrial membrane, respectively. Within the mitochondrion, acyl-CoAs are degraded to acetyl-CoA during β-oxidation. Acetyl-CoA is metabolized in the tricarboxylic acid cycle (TCA, also called citric acid cycle). Citrate from the TCA can be exported to the cytosol, where it inhibits early steps of glycolysis and can be converted to malonyl-CoA. The latter inhibits the carnitine shuttle system and thus fatty acid oxidation. AMPK was shown to inhibit this conversion by blocking Acetyl-CoA carboxylase (ACC). Fruc-1,6-bis-P fructose-1,6-bisphosphate, PFK1/2 phosphofructokinase 1/2

In the heart, the transport capacity of GLUT4 transporters is almost saturated at physiological plasma glucose levels limiting glucose inflow and thus glycolytic flux. Stimulation of GLUT4 trans-

location (see above) elevates glycolytic flux and increases pyruvate, releasing the blockade of PDH by PDH phosphatases (Fig. 2). In consequence, glucose metabolism is elevated despite



the presence of fatty acids. However, the precise interplay of metabolic factors directing cardiac metabolism toward one or the other direction is still not fully understood [8].

The extent of metabolic remodeling is substantially modulated by comorbidities such as diabetes, hypertension, hypercholesterolemia, etc. Thus, identification of the master switches directing cardiac metabolism toward a protective program is of high medical importance.

Further important metabolites released by the heart are nitric oxide (NO) and adenosine. Both of them are only short-lived and exert local functions. These include modulation of coronary vascular tone and cardiac contractility (see below). Moreover, NO and adenosine are able to keep platelets and leukocytes in a quiescent state, acting as antithrombotic and anti-inflammatory factors.

In the heart, NO, which is derived from L-arginine, is synthesized in the coronary endothelium by the endothelial NO synthase (type III NOS). In CMs, the endothelial as well as the neuronal NO synthase (type I NOS) are constitutively expressed. Under inflammatory conditions, also the inducible NO synthase (type II NOS) may be upregulated. NO modulates cardiac contractile function, and depending on the NO concentrations, both positive as well as negative inotropic actions have been described. The underlying mechanism appears to involve modulation of  $\text{Ca}^{2+}$  homeostasis as well as the availability of cAMP due to the modulation of phosphodiesterases. NO-mediated vasodilation involves a direct activation of the soluble guanylyl cyclase, elevation of cGMP, and activation of the cGMP-dependent protein kinase (PKG). PKG in turn activates the myosin light chain phosphatase by phosphorylation, which leads to a dephosphorylation of the regulatory myosin light chain in smooth muscle cells and the concomitant reduction of vascular tone.

Besides NO derived from NOS, recent studies suggest that under hypoxic conditions, deoxygenated hemoglobin and myoglobin reduce circulating nitrite to NO. This interesting concept provides a link between cardiac ischemia and the vasodilatory and cardioprotective functions of NO [9].

Under hypoxic or ischemic conditions, ATP breakdown may lead to the formation of adenosine. Adenosine released from the myocardium or formed extracellularly from ATP is able to elevate cardiac perfusion by the activation of smooth muscle cell  $\text{A}_2\text{A}$  receptors and subsequent enhancement of cAMP. cAMP in turn stimulates PKA, which phosphorylates and thereby inhibits the regulatory myosin light chain kinase and stimulates MLC phosphatase, leading to relaxation. Moreover, activation of  $\text{K}_{\text{ATP}}$  channels via PKA-mediated phosphorylation may lead to hyperpolarization of smooth muscle cells and therefore vasodilation. The cardiac release of adenosine is minimal as long as oxygen supply is sufficient to match the demands [10]. Therefore, in contrast to NO, which is important for the setting of the basal vascular tone, adenosine-mediated vasodilation is more important under hypoxic conditions.

---

### Inside-Out: Metabolites of the Heart Affecting Other Tissues

In the context of inside-out signaling, peptide factors released by the heart act on other organs. The natriuretic peptides (NPs), atrial and brain NP, which are expressed predominantly in the atria and the ventricles, respectively, are released from the heart in response to mechanical signals such as stretch and elevated mechanical load, e.g., during volume overload or exercise. They activate membrane-bound guanylyl cyclase receptors, which elevate cGMP levels in target cells and regulate fluid homeostasis and reduce blood pressure via increased  $\text{Na}^+$  excretion (see chapter “Overview” under part “Kidney”). However, recent results indicate that natriuretic peptides also have an important metabolic function. NP receptors are present on adipocytes and their activation stimulates lipolysis. Interestingly, the potency of NP to enhance lipolysis is similar to that of  $\beta$ -adrenergic stimulation, which represents the classical way. Whereas the latter is mediated by the cAMP–PKA pathway, NPs exert their effects via cGMP and PKG. The physiological role of this pathway can be seen in an elevated supply of heart and skeletal muscle with fatty

acids during exercise, when mechanic forces stimulate the release of NP from the heart [11].

It is well known that heart failure (see chapter “Heart failure”) may be associated with the loss of skeletal muscle. This interconnection of cardiac dysfunction and skeletal muscle wasting has been termed cardiac cachexia. Chronic heart failure leads to upregulation of myostatin expression in cardiac tissue. Myostatin, a cytokine of the transforming growth factor (TGF)- $\beta$  family, inhibits muscle development and might be involved in cardiac cachexia. Exercise reduces myostatin expression, whereas physical inactivity may enhance it. The mechanisms by which myostatin leads to atrophy of skeletal muscle involves a reduced activation of protein kinase B (AKT), which might diminish protein synthesis via low mTOR activity or enhance protein degradation via induction of atrogin-1.

---

### Outside-In: Metabolites of Other Tissues Affecting the Heart

Elevated levels of circulating free fatty acids (FFA) may affect cardiac structure and function in several ways [4]. In rodent models, the elevated uptake of fatty acids, frequently associated with insulin resistance, leads to the development of cardiac lipotoxicity characterized by contractile dysfunction, CMs apoptosis, and fibrosis. An enhanced FFA uptake may increase the cardiac stores of triacylglycerol or triglyceride (TG). Enhanced deposition of TG in the myocardium results in cardiac steatosis, i.e., the ectopic deposition of surplus fatty acids in the form of TG in CMs. The enhanced availability and metabolism of TG also elevate ceramide levels in the heart. Ceramides have been shown to induce apoptosis of CMs by enhancing mitochondrial permeability. Moreover, ceramides inhibit Akt, which are involved in cellular metabolism, growth, and survival. On the other hand, elevated TGs also enhance diacylglycerol known to activate conventional and novel PKC isoforms [12], which may be protective or pathologic. Among the latter, PKC $\beta$ 1 was shown to phosphorylate the  $\beta$  subunit of the insulin receptor as well as insulin receptor substrate 1 (IRS1) on multiple serine/threonine residues thus contributing to insulin resistance.

Also, enhanced glucose levels can have detrimental effects on cardiac function. For example, hyperglycemia enhances diacylglycerol formation and activation of PKC. Interestingly, in the presence of high fatty acid levels, glucose oxidation is blocked. Glucose is redirected to other pathways including the pentose phosphate pathway, which leads to synthesis of NADPH required for the formation of glutathione, an important antioxidant.

---

### Final Remarks

The healthy heart is a metabolic omnivore, which is able to utilize carbon sources including glucose, lactate, ketone bodies, and fatty acids for oxidative generation of ATP. The hypertrophic and failing heart, respectively, switch their metabolism from the usually preferred fatty acids to higher glucose consumption. Although still not unambiguously clarified, many experimental studies indicate that this metabolic remodeling is an important mechanism contributing to adaptation during the compensated state in heart failure progression and encourage to develop metabolic therapies to treat heart failure [13].

---

### References

1. Camelliti P, Borg TK, Kohl P (2005) Structural and functional characterisation of cardiac fibroblasts. *Cardiovasc Res* 65:40–51
2. Rakusan K, Flanagan MF, Geva T, Southern J, Van PR (1992) Morphometry of human coronary capillaries during normal growth and the effect of age in left ventricular pressure-overload hypertrophy. *Circulation* 86:38–46
3. Stanley WC, Recchia FA, Lopaschuk GD (2005) Myocardial substrate metabolism in the normal and failing heart. *Physiol Rev* 85:1093–1129
4. Lopaschuk GD, Ussher JR, Folmes CD, Jaswal JS, Stanley WC (2010) Myocardial fatty acid metabolism in health and disease. *Physiol Rev* 90:207–258
5. Longnus SL, Wambolt RB, Parsons HL, Brownsey RW, Allard MF (2003) 5-Aminoimidazole-4-carboxamide 1-beta -D-ribofuranoside (AICAR) stimulates myocardial glycogenolysis by allosteric mechanisms. *Am J Physiol Regul Integr Comp Physiol* 284:R936–R944
6. Hue L, Taegtmeier H (2009) The Randle cycle revisited: a new head for an old hat. *Am J Physiol Endocrinol Metab* 297:E578–E591

7. Randle PJ, Garland PB, Hales CN, Newsholme EA (1963) The glucose fatty-acid cycle. Its role in insulin sensitivity and the metabolic disturbances of diabetes mellitus. *Lancet* 1:785–789
8. Choi CS, Savage DB, Abu-Elheiga L, Liu ZX, Kim S, Kulkarni A, Distefano A, Hwang YJ, Reznick RM, Codella R, Zhang D, Cline GW, Wakil SJ, Shulman GI (2007) Continuous fat oxidation in acetyl-CoA carboxylase 2 knockout mice increases total energy expenditure, reduces fat mass, and improves insulin sensitivity. *Proc Natl Acad Sci U S A* 104:16480–16485
9. Lundberg JO, Weitzberg E, Gladwin MT (2008) The nitrate-nitrite-nitric oxide pathway in physiology and therapeutics. *Nat Rev Drug Discov* 7:156–167
10. Deussen A, Brand M, Pexa A, Weichsel J (2006) Metabolic coronary flow regulation—current concepts. *Basic Res Cardiol* 101:453–464
11. Moro C, Polak J, Hejnova J, Klimcakova E, Crampes F, Stich V, Lafontan M, Berlan M (2006) Atrial natriuretic peptide stimulates lipid mobilization during repeated bouts of endurance exercise. *Am J Physiol Endocrinol Metab* 290:E864–E869
12. Geraldès P, King GL (2010) Activation of protein kinase C isoforms and its impact on diabetic complications. *Circ Res* 106:1319–1331
13. Ashrafian H, Frenneaux MP, Opie LH (2007) Metabolic mechanisms in heart failure. *Circulation* 116:434–448

---

# Atherosclerotic Heart Disease

Massimo Slavich and Juan Carlos Kaski

---

## Introduction to Atherosclerotic Heart Disease

### Coronary Artery Disease

Coronary atherosclerosis, also termed coronary artery disease (CAD), is the most common type of heart disease and the most frequent cause of acute myocardial infarction. CAD accounts for approximately 15 % of all deaths in the developed nations. Despite the high prevalence (approximately 20 % in people over 60 years of age), a relevant reduction of CAD mortality has been seen in the last decades due to coronary reperfusion strategies, advances in antianginal medical therapy, heart failure treatment, and better control of cardiovascular risk factors.

CAD is a chronic inflammatory disorder characterized by focal lipid deposition within the arterial wall, which leads to the formation of atheromatous plaques that can reduce the coronary lumen and the blood supply to the myocardium (myocardial ischemia). CAD progression can lead to ischemic cardiomyopathy, a condition involving ischemic chronic left ventricular (LV) dysfunction and remodeling [1].

For its function, myocardium requires a continuous supply of oxygen via the coronary tree

(see chapter “**Overview**” under part “**Heart**”). In subjects with healthy coronary arteries, blood flow increases as appropriate to match increased myocardial metabolic demand (coronary blood flow reserve). When an atherosclerotic lesion is present that affects blood flow, ischemia develops, as oxygen delivery cannot match myocardial requirements. This mechanism is often present in chronic stable angina pectoris (CSA), which usually manifests itself with exertional chest pain that is relieved by rest and/or with the administration of sublingual nitroglycerin, a nitric oxide (NO) donor [2]. This is different from acute myocardial infarction, which occurs when a coronary artery is acutely and unexpectedly occluded due to coronary thrombosis and/or epicardial coronary artery spasm. Under these circumstances, if the patency of the coronary is not restored promptly, necrosis of cardiac myocytes (CMs) ensues.

In the presence of reduced oxygen delivery, maladaptive metabolic changes occur within the myocardial cells.

This chapter discusses the mechanisms and major pathways of atheromatous plaque formation and myocardial ischemic conditions, mainly CSA.

---

## Atherosclerotic Plaque Formation and Myocardial Metabolic Changes

Atheromatous plaque initiation and growth involve oxidized low-density lipoprotein (LDL), cholesterol deposition, endothelial activation and dysfunction, and inflammatory cell (i.e., macrophages

---

M. Slavich • J.C. Kaski (✉)  
Cardiovascular Sciences Research Centre,  
St George’s University of London,  
Cranmer Terrace, London SW17 0RE, UK  
e-mail: [massimo.slavich@gmail.com](mailto:massimo.slavich@gmail.com);  
[jkaski@sgul.ac.uk](mailto:jkaski@sgul.ac.uk)

and lymphocytes) activation [1]. Elevated concentrations of circulating LDL cholesterol facilitate subendothelial ApoB lipoprotein retention especially in arterial sites showing turbulent flow. Once in the arterial intima, LDL particles undergo oxidation (e.g., by reactive oxygen species). Debris and cholesterol crystals accumulate in the vessel wall, associated with accumulation of different leukocytes. Lipid peroxidation in the plaque enhances the expression of adhesion molecules that can in turn contribute to intimal leukocyte recruitment. Subsequent structural modifications progressively weaken the arterial wall.

Within the atheromatous plaque, several pro- and anti-inflammatory cytokines and chemokines contribute to lesion growth, e.g., migration inhibitory factor and type 1 interferons, are typically overexpressed and exert proinflammatory and proatherogenic functions. Increased amounts of chemotactic chemokines recruit leukocytes and mediate transendothelial diapedesis.

Within these initial lesions, known as “fatty streaks,” recruited monocytes differentiate into macrophages, which ingest LDL. These lipid-laden monocytes turn into foam cells. Subsequently, a necrotic core forms, surrounded by a fibrous cap composed of collagen and smooth muscle cells. Neutrophils and dendritic cells (DCs) are also involved in the progression of the atheroma. DCs take up lipids and further accumulate in clusters with T cells in the so-called high-risk rupture plaque region. In this region, T cells account for almost 20 % of the cells in the plaque. Their proinflammatory status further enhances leukocyte recruitment and activation. Local inflammatory processes lead to the degradation of the collagen in the fibrous cap and the extracellular matrix weakening the fibrous cap and compromise plaque stability. A thin fibrous cap and continuous accumulation of lipids can create a “high-risk” or “vulnerable” plaque. Through the release of metalloproteinases, macrophages have a pivotal role in plaque rupture [1, 3].

### **Myocardial Ischemia and Heart Metabolism**

Heart metabolism critically relies on the production of sufficient ATP to allow muscle contraction and  $\text{Ca}^{2+}$  cycling. The intracellular  $\text{Ca}^{2+}$

levels are strictly controlled and their increase, subsequent to metabolic dysfunction, leads to impaired CM contractility (Fig. 1) [4].

Under physiological conditions, free fatty acids (FFA) are the main source of energy, which is more efficient than carbohydrate oxidation, albeit at the expense of greater oxygen consumption (see chapter “Overview” under part “Heart”). A rapid increase in workload induces a shift from FFA to glucose oxidation (metabolic switch). During myocardial ischemia, diminished perfusion leads to inadequate oxygen delivery that compromises oxidative phosphorylation and therefore ATP generation. The diminished ATP levels induce the loss of contractile force and reduce the activity of ATP-dependent ion transporters (Fig. 1). Even under hypoxic conditions, the myocardium continues to derive a large proportion of its energy from FFA oxidation. However, in order to supply more ATP, glycolysis increases, prevailing over FFA oxidation. This leads to further metabolic changes, including intracellular acidosis, modified signaling, increased saturated FFA oxidation, and possibly apoptosis [5].

After a severe ischemic event, CMs can remain viable in the form of “stunned myocardium” which describes a prolonged but reversible LV dysfunction that initially persists despite the restoration of blood flow to the affected area. “Myocardial hibernation,” another form of myocardial oxygen deprivation and reduced ventricular function, develops in response to a chronic and substantial reduction of coronary blood supply; in both hibernating and stunned myocardium, cells are still alive but do not have enough energy to contract.

In the short term, a reduced contractile response to  $\text{Ca}^{2+}$  is present during hibernation. During prolonged hibernation, fetal genes are reactivated resulting in a switch from fat to glucose metabolism [6, 7]. On restoring artery patency, FFA oxidation becomes active again, prevailing over glucose oxidation.

Revascularization may improve or restore the functional capacity in the hibernated area. Although the restoration of blood flow to ischemic myocardium is beneficial, on occasions, it can lead to further cell damage, i.e., “myocardial reperfusion injury” [8]. This is characterized by

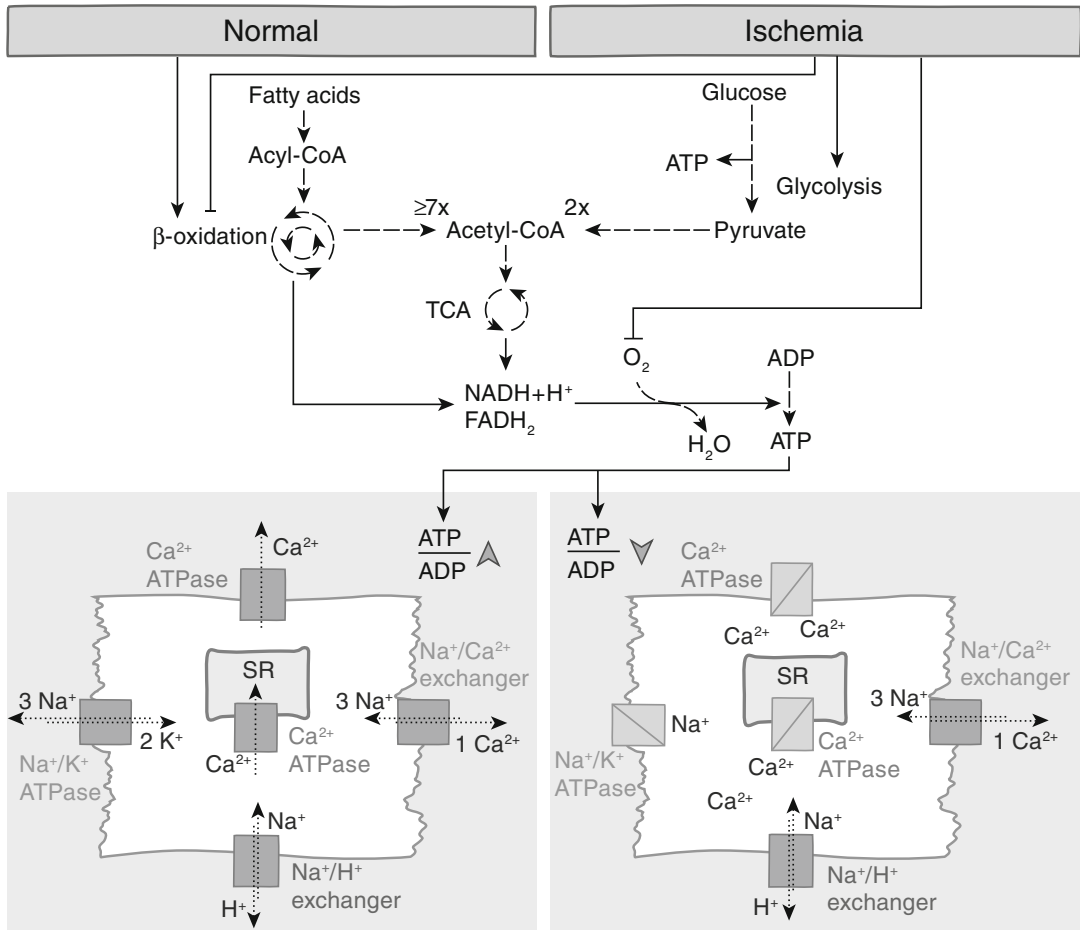

**Fig. 1** Metabolic changes during myocardial ischemia. *Upper part:* Whereas fatty acid (FA) oxidation via  $\beta$ -oxidation is the preferred source of energy under normal oxygen supply, under hypoxic conditions (ischemia), energy metabolism switches to glucose oxidation, which requires less oxygen but also yields less ATP. Ischemia acts by reducing  $\beta$ -oxidation, increasing glycolysis, and limiting the supply of  $O_2$  for oxidative phosphorylation. TCA, tricarboxylic acid cycle (also called citric acid cycle). *Lower part:* During ischemia, ATPase function is impaired as the ATP/ADP ratio is decreased. This leads to an intracellular  $Ca^{2+}$  and  $Na^+$  overload, as  $Na^+/H^+$  exchanger and  $Na^+/Ca^{2+}$  exchanger remain active, whereas  $Na^+/K^+$ -ATPase and  $Ca^{2+}$ -ATPase are dysfunctional. The resulting increase in  $Ca^{2+}$  further impairs myocardial function. SR sarcoplasmic reticulum

TCA, tricarboxylic acid cycle (also called citric acid cycle). *Lower part:* During ischemia, ATPase function is impaired as the ATP/ADP ratio is decreased. This leads to an intracellular  $Ca^{2+}$  and  $Na^+$  overload, as  $Na^+/H^+$  exchanger and  $Na^+/Ca^{2+}$  exchanger remain active, whereas  $Na^+/K^+$ -ATPase and  $Ca^{2+}$ -ATPase are dysfunctional. The resulting increase in  $Ca^{2+}$  further impairs myocardial function. SR sarcoplasmic reticulum

$Ca^{2+}$  overload and the release of cytotoxic reactive oxygen species induced by the sudden restoration of blood flow [8].

### Antianginal Treatment and Influence of Treatment on Cardiac Metabolism

First, appropriate management of modifiable risk factors, i.e., obesity (see chapter “[Metabolic syndrome](#)”), smoking, dyslipidemia (see chapter “[Hyperlipidemia](#)”), hypertension (see chapter

“[Hypertension](#)”), and diabetes mellitus (see chapter “[Diabetes mellitus](#)”), reduces ischemic events and long-term cardiovascular risk. A healthy lifestyle, reduced oxidative stress, inflammation, and improved cardiac metabolism represent useful measures to reduce cardiovascular risk.

Pharmacological agents available at present act by reducing oxygen demand, increasing coronary blood flow, or affecting myocardial metabolism directly. Although medical treatment in CSA patients often provides effective control of symptoms [9], some patients require

percutaneous coronary intervention (PCI), in which a balloon is inflated within the occluded artery to improve coronary blood flow and prevent recurrent ischemia [2]. Especially in acute ischemia, rapid restoration of coronary blood flow to the affected area with PCI results in reduced mortality.

Obstructive stenoses that reduce blood flow and cause symptoms can be effectively treated with bypass surgery or PCI and stenting. Deploying a stent restores coronary blood flow and results in symptom improvement.

## Pharmacological Treatment of Angina Pectoris

Current pharmacological CAD treatment aims to (i) abolish or reduce symptoms and improve quality of life, (ii) prevent ischemic episodes, (iii) reduce CAD progression and the risk of acute coronary events, and (iv) improve survival. Pharmacological antianginals act by reducing myocardial oxygen demand and/or improving blood supply via peripheral and coronary vasodilation and reduction of blood pressure and heart rate. While for many years the treatment of CAD has been based on agents acting on hemodynamic mechanisms, pharmacological agents are now available that beneficially affect the metabolic response of the ischemic heart and represent a useful alternative or adjunct to conventional antianginal agents [5]. Finally, agents that improve endothelial function are also useful.

Identifying the prevailing mechanism responsible for the development of myocardial ischemia is useful to design rational therapeutic strategies to reduce symptoms and prevent ischemic episodes. In patients with angina triggered by coronary artery spasm leading to a primary reduction of O<sub>2</sub> supply, vasodilators are the first-line therapy. In patients with obstructive CAD, drugs that reduce heart rate and blood pressure, such as  $\beta$ -blockers and calcium channel blockers (CA), are desirable. Negative chronotropic agents are especially useful, as heart rate is a major determinant of energy expenditure and prognosis [10]. In developed CSA, different therapeutic options are

required to protect and rescue damaged myocardium. Nitrates improve oxygen supply (by vasodilating activity) and reduce myocardial metabolic demand (by reducing ventricular pre- and afterload). Diuretics and angiotensin converting enzyme inhibitors (see chapter “Hypertension”) are commonly used in order to reduce the ventricular loading, especially in patients with advanced CAD and systolic dysfunction.

CAs act as vasodilators by preventing effective constriction of smooth muscle cells and reducing the heart rate (negative chronotropic effect). Non-dihydropyridine CAs have negative inotropic effects, reducing heart contractility, as higher level of Ca<sup>2+</sup> in CMs is required for effective contraction.

$\beta$ -Blockers act on multiple levels to improve disease progression and outcome, by blocking  $\beta$ -adrenergic receptors. They show negative inotropic and chronotropic effects, acting on the heart directly providing a reduction of oxygen demand and preventing transient myocardial ischemia. Some classes (carvedilol) additionally have a direct metabolic effect, inducing a metabolic shift to glucose utilization, reducing FFA uptake [11]. Finally, they enhance the bioavailability of NO, inducing vasodilation [12].

Ivabradine is a novel drug, which only lowers the heart rate (negative chronotropic), without interfering with the inotropism, because of its selective inhibition of the funny current (a mixed sodium-potassium current) in the cardiac pacemaker myocytes [13]. On the other side, drugs as dopamine and epinephrine are able to increase the inotropism and the chronotropism and are effective especially in advanced CAD and in patients with severely impaired LV function.

Trimetazidine and ranolazine directly modulate CM metabolism and thus reduce heart energy demand and loading conditions of the LV. This modifies neurohormonal activation and delays the occurrence of cardiac remodeling (see chapter “Heart failure” and Fig. 2). They have no direct effects on blood pressure or heart rate and are used as adjunctive therapy.

Trimetazidine inhibits the action of 3-ketoacyl coenzyme A thiolase, an enzyme implicated in the  $\beta$ -oxidation [14]. The resulting switch from FFA to



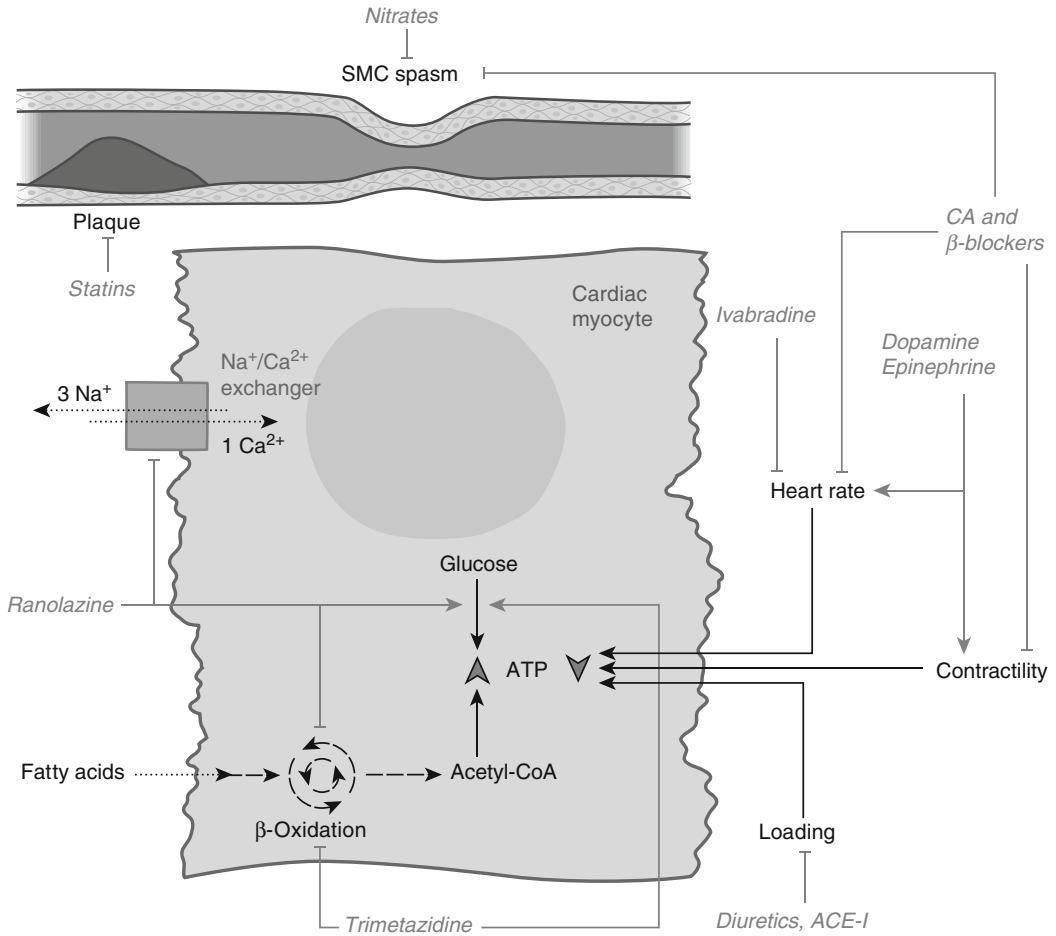

**Fig. 2** Effects of treatment on cardiac metabolism. Statins interfere with atheromatous plaque formation in blood vessels by reducing the available cholesterol. Nitrates stimulate vasodilation via a nitric oxide (NO)-dependent effect on smooth muscle cells, increasing the blood supply to the cardiac myocytes (CMs).  $Ca^{2+}$  channel antagonists (CA) are effective in the regulation of spasm control, acting on vascular smooth muscle cells. Heart rate can be decreased (by CAs,  $\beta$ -blockers, and ivabradine) to prevent excessive strain (negative chronotropy) and can be increased (by dopamine and epinephrine) to prevent life-threatening reductions in

contractility in late-stage and severe coronary artery disease (positive chronotropy). Cardiac contractility can be increased by dopamine and epinephrine and depressed by CA and  $\beta$ -blockers (positive and negative inotropy, respectively). Enhanced cardiac activity (heart rate, inotropism) requires a lot of ATP and thus oxygen. Diuretics and angiotensin converting enzyme inhibitor (ACE-I) reduce ventricular loading. Ranolazine and trimetazidine directly act on the metabolic pathway of the CMs, by favoring glucose oxidation and inhibiting  $\beta$ -oxidation. Ranolazine also reduces  $Ca^{2+}$  overload at the level of the  $Na^+/Ca^{2+}$  exchanger

glucose oxidation optimizes cellular energy processes and enhances ATP production during ischemia, as glycolysis requires less oxygen [15]. In this way, trimetazidine ensures the proper functionality of ion pumps, prevents CM apoptosis, and limits myocardial reperfusion injury [16], improving the LV function and long-term survival [17].

Ranolazine is a partial FFA oxidation inhibitor and shifts ATP production from FFA to glucose

oxidation. Moreover, it prevents calcium overload during myocardial ischemia by inhibiting the  $Na^+/Ca^{2+}$  exchanger. In CAD patients, the addition of ranolazine to standard therapy decreases angina recurrences and increases exercise tolerance [18].

In order to interfere with the plaque formation and progression, achieving normal cholesterol levels is recommended. Statins inhibit

hydroxymethylglutaryl-CoA reductase, a key enzyme in cholesterol synthesis (see chapter “Hyperlipidemia”), lowering the circulating cholesterol level thus acting on or preventing atherosclerotic lesions [19]. Since atherosclerotic plaque disruption exposes the procoagulant endothelial layer, antiplatelet agents are also adopted in order to prevent thrombus formation.

## Perspectives

Treatment of CAD aims to improve the patient’s life quality and to reduce serious cardiovascular events that may lead to death or further morbidity. Despite the significant reduction in CAD mortality and morbidity in recent years, several issues still need to be addressed, i.e., mechanisms of atherosclerotic plaque progression, the early identification of atheromatous plaques prone to rupture, and the rational management of the different forms of ischemic heart disease.

Early reperfusion strategies in myocardial infarction have also resulted in a significant reduction of infarct size and mortality, but many issues still remain unsolved, including how to minimize reperfusion injury after acute coronary revascularization.

CSA affects a large proportion of individuals worldwide and its pharmacological treatment, albeit effective in a large proportion of cases, is far from ideal. The advent of newer antianginal drugs that directly affect metabolic pathways in the myocardium has opened new avenues for CAD management. Notably, technical advances in the field of coronary revascularization with new generations of biodegradable stents [20] are expected to result in improved patient management and less in-stent restenosis.

## References

1. Hansson GK (2005) Inflammation, atherosclerosis, and coronary artery disease. *N Engl J Med* 352: 1685–1695
2. Gibbons RJ, Gibbons RJ, Abrams J, Chatterjee K, Daley J, Deedwania PC, Douglas JS, Ferguson TB Jr,

- Fihn SD, Fraker TD Jr, Gardin JM, O’Rourke RA, Pasternak RC, Williams SV (2003) ACC/AHA 2002 guideline update for the management of patients with chronic stable angina. *J Am Coll Cardiol* 41:159–168
3. Dumitriu IE, Araguás ET, Baboonian C, Kaski JC (2009) CD4+ CD28 null T cells in coronary artery disease: when helpers become killers. *Cardiovasc Res* 81:11–19
4. Neubauer S (2007) The failing heart—an engine out of fuel. *N Engl J Med* 356:1140–1151
5. Lee L, Horowitz J, Frenneaux M (2004) Metabolic manipulation in ischaemic heart disease, a novel approach to treatment. *Eur Heart J* 25:634–641
6. Ferrari R, Ceconi C, Curello S, Benigno M, La Canna G, Visioli O (1996) Left ventricular dysfunction due to the new ischemic outcomes: stunning and hibernation. *J Cardiovasc Pharmacol* 28:S18–S26
7. Cooper HA, Braunwald E (2001) Clinical importance of stunned and hibernating myocardium. *Coron Artery Dis* 12:387–392
8. Yellon DM, Hausenloy DJ (2007) Myocardial reperfusion injury. *N Engl J Med* 357:1121–1135
9. Weintraub WS, Spertus JA, Kolm P, COURAGE Trial Research Group et al (2008) Effect of PCI on quality of life in patients with stable coronary disease. *N Engl J Med* 359:677–687
10. Fragasso G, De Cobelli F, Spoladore R, Esposito A, Salerno A, Calori G, Montanaro C, Maranta F, Lattuada G, Margonato A, Del Maschio A, Perseghin G (2011) Resting cardiac energy metabolism is inversely associated with heart rate in healthy young adult men. *Am Heart J* 162:136–141
11. Wallhaus TR, Taylor M, DeGrado TR, Russell DC, Stanko P, Nickles RJ, Stone CK (2001) Myocardial free fatty acid and glucose use after Carvedilol treatment in patients with congestive heart failure. *Circulation* 103:2441–2446
12. Vanhouette PM, Gao Y (2013) Beta blockers, nitric oxide, and cardiovascular disease. *Curr Opin Pharmacol*. doi:10.1016/j.coph.2012.12.002
13. Fox K, Ford I, Steg PG, Steg PG, Tendra M, Ferrari R (2008) Ivabradine for patients with stable coronary artery disease and left-ventricular systolic dysfunction (BEAUTIFUL): a randomised, double-blind, placebo-controlled trial. *Lancet* 372:807–816
14. Bertomeu-Gonzalez V, Bouzas-Mosquera A, Kaski JC (2006) Role of trimetazidine in management of ischemic cardiomyopathy. *Am J Cardiol* 98:19J–24J
15. Fragasso G, Rosano G, Baek SH, Sisakian H, Di Napoli P, Alberti L, Calori G, Kang SM, Sahakyan L, Sanosyan A, Vitale C, Marazzi G, Margonato A, Belardinelli R (2013) Effect of partial fatty acid oxidation inhibition with trimetazidine on mortality and morbidity in heart failure: results from an international multicentre retrospective cohort study. *Int J Cardiol* 163:320–325
16. Fragasso G, Palloschi A, Puccetti P, Silipigni C, Rossodivita A, Pala M, Calori G, Alfieri O, Margonato A (2006) A randomized clinical trial of trimetazidine,

- a partial free fatty acid oxidation inhibitor, in patients with heart failure. *J Am Coll Cardiol* 48:992–998
17. Fragasso G, Perseghin G, De Cobelli F, Esposito A, Palloschi A, Lattuada G, Scifo P, Calori G, Del Maschio A, Margonato A (2006) Effects of metabolic modulation by trimetazidine on left ventricular function and phosphocreatine/adenosine triphosphate ratio in patients with heart failure. *Eur Heart J* 27:942–948
  18. Nash DT, Nash SD (2008) Ranolazine for chronic stable angina. *Lancet* 372:1335–1341
  19. Nissen SE, Tuzcu EM, Schoenhagen P (2005) Statin therapy, LDL cholesterol, C-reactive protein, and coronary artery disease. *N Engl J Med* 352:29–38
  20. Haude M, Erbel R, Erne P, Verheye S, Degen H, Böse D, Vermeersch P, Wijnbergen I, Weissman N, Prati F, Waksman R, Koolen J (2013) Safety and performance of the drug-eluting absorbable metal scaffold (DREAMS) in patients with de-novo coronary lesions: 12 month results of the prospective, multicentre, first-in-man BIOSOLVE-I trial. *Lancet* 381:836–844

---

# Heart Failure

Roman Pfister and Erland Erdmann

---

## Introduction to Heart Failure

Heart failure (HF) can be defined as an abnormality of cardiac structure or function leading to failure of the heart to deliver oxygen at a rate commensurate with the requirements of the metabolizing tissues [1]. A multitude of inherited or acquired cardiac and extracardiac abnormalities can terminate in HF, with the most frequent causes in developed countries being coronary heart disease with ischemic injury of the myocardium (see chapter “[Atherosclerotic heart disease](#)”) and pressure overload due to hypertension (see chapter “[Hypertension](#)”). The prevalence of HF in adults is 1–2 %, rising to more than 10 % in people aged > 70 years [1]. HF, particularly in advanced stages, is associated with an estimated lifetime cost of \$110,000 per patient and year [2] and a mortality of 40 % within 5 years [1, 3]. About half of the HF patients are found to have preserved ejection fraction (HFpEF or diastolic HF) with impaired filling of the ventricle due to disturbed relaxation or increased stiffness, whereas the other half has reduced ejection fraction (HFrEF or systolic HF) [1]. Diastolic HF is often associated with higher age, female gender, hypertension

(see chapter “[Hypertension](#)”), diabetes (see chapter “[Diabetes mellitus](#)”) and obesity, and a cardiac phenotype of hypertrophy and left atrial enlargement, whereas systolic HF is associated with male gender, coronary heart disease, and a dilated left ventricle.

The major clinical issue in HF patients is fluid overload causing peripheral edema and dyspnea (shortness of breath) due to pulmonary congestion, which is caused by salt and water retention (see below).

---

## Pathology of Heart Failure

HF is progressive in nature (Fig. 1). Initially, an injury such as myocardial infarction with loss of muscle or a global contractile insufficiency due to primary cardiomyopathies or chronic overload leads to ventricular dysfunction. If dysfunction exceeds certain limits, the cardiac output will decrease leading to perceived reduction in circulating blood volume and/or pressure with insufficient perfusion of tissue. The latter activates systemic neurohumoral responses to increase tissue perfusion via vasoconstriction, retention of salt and water, and initially increase of cardiac output [4].

The key neurohumoral systems, which initiate many of these remodeling processes and hence substantially contribute to progression of HF, are the sympathetic nervous system (SNS) and the renin-angiotensin-aldosterone system [1]. Albeit expedient in the acute setting, in the long term, these responses further worsen

---

R. Pfister (✉) • E. Erdmann  
Department III of Internal Medicine,  
Uniklinik Köln, Herzzentrum,  
Kerpener Str. 62, Köln 50937, Germany  
e-mail: [roman.pfister@uni-koeln.de](mailto:roman.pfister@uni-koeln.de);  
[erland.erdmann@uni-koeln.de](mailto:erland.erdmann@uni-koeln.de)

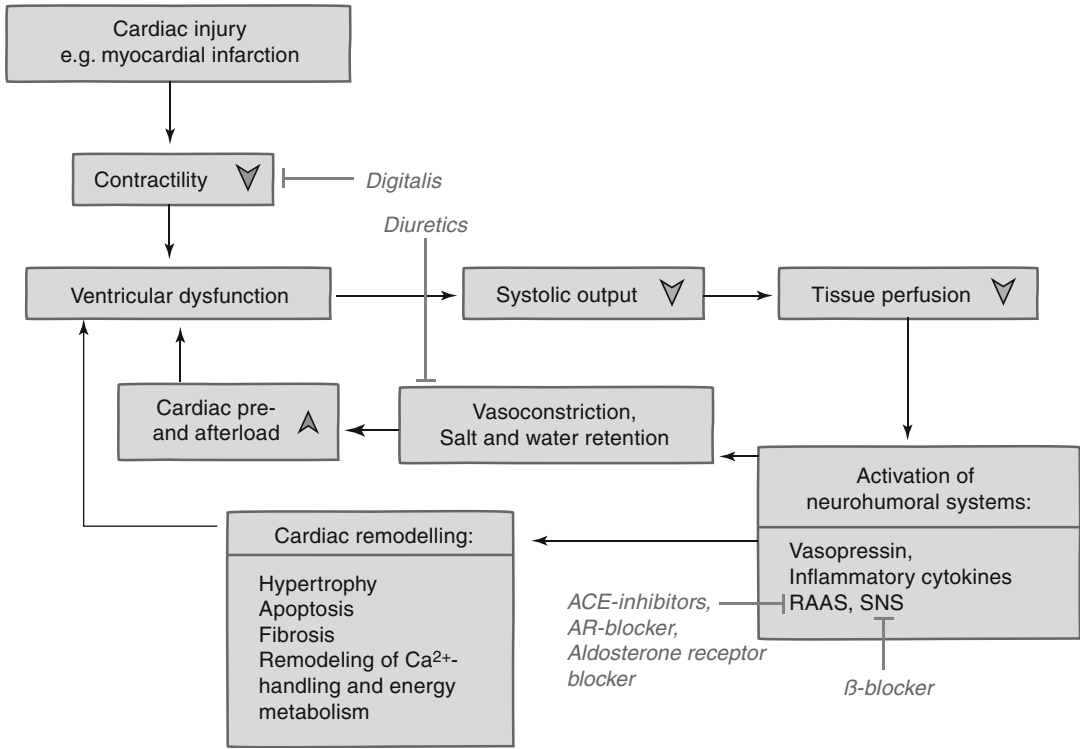

**Fig. 1** Pathophysiology of heart failure and common treatments. Development and progression of heart failure by an injury such as myocardial infarction is mediated by neurohumoral systems. A vicious circle of reduced cardiac output leads to the activation of neurohumoral systems. The subsequent increase in blood volume and

vasoconstriction, however, puts even more load on the challenged heart and promotes pathological remodeling. SNS sympathetic nervous system, RAAS renin-angiotensin-aldosterone system, ACE angiotensin-converting enzyme, AR angiotensin II receptor

cardiac hemodynamics with increase in pre- and afterload (due to increased volume and peripheral resistance, respectively). They also have direct detrimental effects on the myocardium with progressive ventricular dilation and deterioration of contractility but also on blood vessels, kidneys, muscles, bone marrow, etc. All changes on a structural, functional, histopathological, or cellular level occurring during development and progression of HF are summarized as cardiac remodeling [5].

Taken together, these responses create a “vicious cycle,” worsening cardiac function and accounting for many systemic disarrangements contributing to HF, such as endothelial dysfunction, the cardiorenal syndrome, or systemic inflammation.

### Pathophysiology of Heart Failure and Metabolic Alterations

Cardiac remodeling processes comprise hypertrophy of cardiac myocytes (CMs), changes in CM electrical properties (including calcium (Ca<sup>2+</sup>) handling), energy metabolism, and cell viability (apoptosis) [4]. Additionally, the non-CM compartment also remodels, with extracellular fibrosis and activation of collagenolytic enzymes (matrix metalloproteinases) contributing to decreased chamber compliance, cardiac dilatation, and remodeling of the myocardial vasculature [6]. The sum of these remodeling pathways activated by SNS and renin-angiotensin-aldosterone system contribute to disease progression.

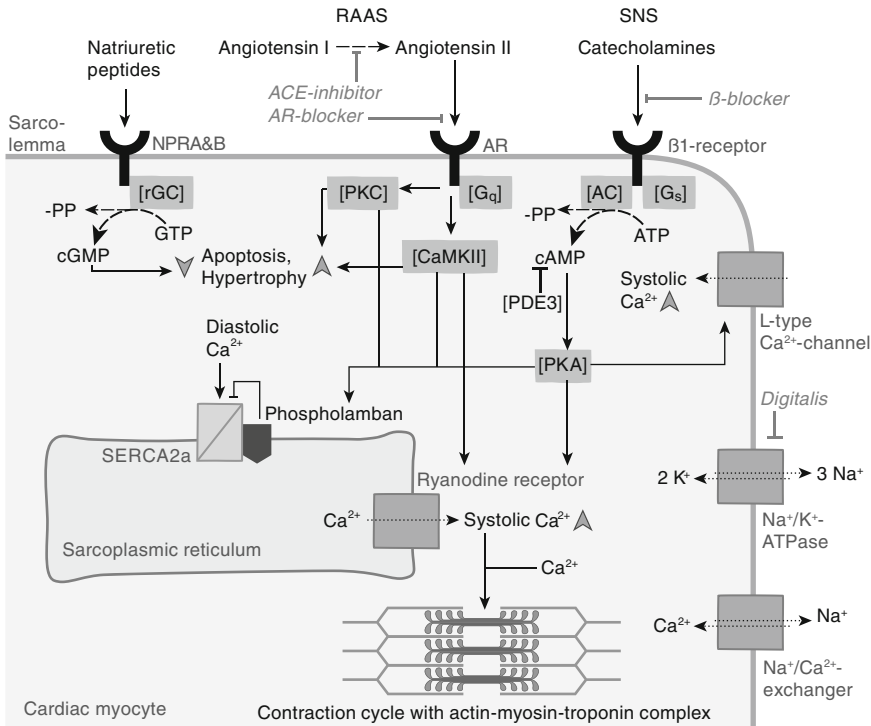

**Fig. 2** Cardiac myocyte signaling pathways involved in heart failure and current therapeutic targets. Natriuretic peptides exert anti-apoptotic and anti-hypertrophic effects via receptor-bound guanylate cyclase (*rGC*) increasing cGMP. The renin-angiotensin-aldosterone system (RAAS) or more specifically angiotensin II activates protein kinase C (*PKC*) and calcium-calmodulin-dependent protein kinase II (*CaMKII*) via  $G_q$  downstream signaling of the angiotensin II receptor (*AR*). *PKC* and *CaMKII* show pro-apoptotic effects. Catecholamines from the sympathetic nervous system (*SNS*) increase intracellular cAMP via

$\beta_1$ -receptor and associated  $G_s$  and adenylyl cyclase (*AC*) proteins. *CaMKII* and *PKA* increase leakage of  $Ca^{2+}$  from the sarcoplasmic reticulum via ryanodine receptor hampering regular systolic contractions. *PKA* also activates L-type  $Ca^{2+}$ -channels. All three (*PKA*, *PKC*, *CaMKII*) negatively influence sarcoplasmic/endoplasmic reticulum  $Ca^{2+}$ -ATPase (*SERCA2a*) via activation of its inhibitor phospholamban, thus hindering reuptake of  $Ca^{2+}$ . Digitalis is used to effectively increase intracellular  $Ca^{2+}$  via inhibition of  $Na^+/K^+$ -ATPase. *NPR* natriuretic peptide receptor, *PP* pyrophosphate, *ACE* angiotensin-converting enzyme

Initially, atrial and brain natriuretic peptides (see chapter “[Overview](#)” under part “[Heart](#)”) counteract the detrimental effects by inhibiting SNS and renin-angiotensin-aldosterone system and mediating anti-hypertrophic and anti-apoptotic effects on a cellular level (via cGMP, Fig. 2) [4, 7]. However, responsiveness to natriuretic peptides decreases during HF progression, favoring systems mediating adverse hemodynamics and remodeling processes.

Typically, remodeling processes in CMs are activated primarily by signaling pathways induced by catecholamines and angiotensin II and secondarily by cytokines or growth factors

such as interleukin-6, tumor necrosis factor  $\alpha$  ( $TNF\alpha$ ), or insulin-like growth factors (Fig. 2).

Particularly, G protein-coupled receptors are activated, signaling via  $G_q$  in case of the angiotensin II receptor and  $G_s$  in the case of  $\beta_1$  adrenoceptors. The  $\beta_1$  adrenoceptors activate adenylyl cyclase to increase cAMP, which acts on protein kinase A (*PKA*) and thereby activates L-type calcium channels (Fig. 2). The angiotensin II receptor acts on phospholipase C and, subsequently, *PKC* and Ca-calmodulin-dependent kinase II (*CaMKII*). Whereas *CaMKII* and *PKA* favor hypertrophic growth, *CaMKII* and *PKC* negatively influence cell survival (Fig. 2) [8].

Unfortunately, the assignment of pathological phenotypes to an individual ligand or cascade failed so far.

Poorly understood mechanotransduction events, which translate mechanical forces into intracellular signaling, also contribute to cardiac remodeling.

Finally, a reduced  $\text{Ca}^{2+}$  transient amplitude and raised diastolic  $\text{Ca}^{2+}$  concentration are found in HF. This is caused by (i)  $\text{Ca}^{2+}$  leaks from the sarcoplasmic reticulum through inappropriate activation of ryanodine receptor channels (which physiologically release  $\text{Ca}^{2+}$  from the sarcoplasmic reticulum during systole), via of CaMKII and PKA, (ii) and a loss of function of the sarcoplasmic/endoplasmic reticulum  $\text{Ca}^{2+}$ -ATPase (SERCA2a, which recycles  $\text{Ca}^{2+}$  to the sarcoplasmic reticulum during diastole) due to reduced SERCA2a protein levels and increased inhibition by phospholamban, which is downstream of CaMKII, PKA, and PKC. Both abnormalities lead to a reduced contractile force, diastolic dysfunction, and arrhythmias [9].

---

## Treatment of Heart Failure

In HF, the underlying cause can rarely be cured since damage to the myocardium usually is irreversible. One exception is reversible dysfunction due to temporary myocardial ischemia (see chapter “[Atherosclerotic heart disease](#)”), which has to be resolved rapidly to prevent permanent changes. Hence, treatment focuses on relief of symptoms and modification of disease progression. Currently, treatment with demonstrated benefit on survival only exists for HFrEF (see below), whereas other treatments solely improve quality of life.

As impaired cardiac contractility is the origin of HF, it provides the most obvious target for therapy. Although the SNS is the most powerful stimulator of cardiac contractility, downregulation and desensitization of the  $\beta$ -adrenoreceptors blunt the effect of adrenergic agonists on contractility [10]. Enhancement of adrenergic signaling with catecholamine derivatives and with phosphodiesterase-3 inhibitors increases cAMP and cytosolic  $\text{Ca}^{2+}$  (Fig. 2).

Another long-established approach to enhance contractility is digitalis, which inhibits the  $\text{Na}^+/\text{K}^+$ -ATPase, secondarily increasing cytosolic  $\text{Ca}^{2+}$  via the  $\text{Na}^+/\text{Ca}^{2+}$  exchanger (Fig. 2).

Interestingly, none of these positive inotropic (contractile force-increasing) drugs improve survival, but rather increase mortality [11], as enhanced contractility is accompanied by increased oxygen demand, resulting in ischemia and life-threatening arrhythmias. Hence, positive inotropic agents are restricted to acute life-threatening episodes of low cardiac output in order to maintain the necessary minimum of vital tissue perfusion. Novel inotropic agents act by sensitizing myofilaments to  $\text{Ca}^{2+}$  (levosimendan) [12] or direct activation of myosin (omecamtiv mecarbil) and seem to be better tolerated, but long-term effects on disease course are still unclear [13].

Mainstay of current HF treatment, however, is the inhibition of neurohumoral systems. The three columns of medical treatment with proven survival benefit in symptomatic patients with HFrEF are (i)  $\beta$ -blockers, which inhibit the effects of SNS; (ii) inhibitors of the angiotensin-converting-enzyme (ACE) or alternatively angiotensin receptor (AR) blockers, which inhibit generation or receptor binding of angiotensin II, respectively; and (iii) aldosterone receptor antagonists (Fig. 1). All treatments result in so-called reverse remodeling, i.e., reversal of adverse remodeling processes [14]. In vitro,  $\beta$ -blockers were demonstrated to enhance  $\text{Ca}^{2+}$ -handling via restoration of ryanodine receptor function and upregulation of SERCA2a and improve adrenergic responsiveness of failing myocardium [15, 16]. Clinically,  $\beta$ -blockers are associated with increased survival, reduced symptoms, and improvement of systolic function [1]. Using a negative inotropic effect as treatment might seem paradoxical, yet chronic  $\beta$ -blocker treatment allows recovery of intrinsic catecholamine-dependent cardiac inotropism by sensitization of adrenergic receptors [17]. Further,  $\beta$ -blockers reduce heart rate (negative chronotropy) and thus the oxygen demands of the failing heart. There is a strong relation of elevated heart rate with disease progression, prognosis, and remodeling processes.



Hemodynamically, ACE inhibitors and AR blockers reduce cardiac afterload by blunting the vasoconstricting effect of angiotensin II. Additionally, both were shown to reduce myocardial collagen content and left ventricular mass and size, and they modestly increase the ejection fraction [14, 18]. Besides its diuretic effects (see chapter “[Hypertension](#)”), blockade of the aldosterone receptor reduces cardiac fibrosis via inhibition of cardiac collagen expression. In addition, it improves cardiac function with prevention of ventricular dilation [19, 20]. Other diuretics also decrease fluid overload by increasing renal fluid and sodium elimination [1].

A novel drug, ivabradine, inhibits a sodium-potassium channel  $I(f)$  which is selectively expressed in sinus node CMs (the pacemakers).  $I(f)$  is responsible for the spontaneous diastolic depolarization, the velocity of which determines heart rate. This  $I(f)$  (or “funny”) current inhibitor thus acts independently of neurohumoral systems (as a negative chronotropic agent) and was shown to significantly decrease hospitalizations and to improve symptoms in patients with systolic HF. However, the underlying molecular mechanisms remain unclear, and a benefit on mortality has not been demonstrated [21].

Developments of interventional HF treatment using electrical devices aim at modifying complications of remodeling processes. Malignant arrhythmias can be treated by pacemaker devices, which detect arrhythmias and terminate them by high-frequency stimulation or shock. Asynchronous myocardial contraction can be treated by biventricular pacemakers [1].

---

## Influence of Treatment on Metabolism

$\beta$ -Blockers decrease stroke volume, systemic vascular resistance, and renal release of renin and, hence, contribute to a decrease in blood pressure (see chapter “[Hypertension](#)”). As  $\beta$ -blockers show negative chrono- and dromotropic effects (decreasing heart rate and conduction speed of the electrical signal), they are applied in patients with symptomatic coronary

ischemia to decrease oxygen consumption and to treat tachycardic rhythm disorders originating in the atria. Although currently used  $\beta$ -blockers are somewhat selective for  $\beta_1$ -adrenoreceptors, dose-dependent effects on  $\beta_2$  receptors are possible at high doses. This can be clinically relevant in patients with asthma (see chapter “[Asthma](#)”) who might develop bronchospasm in response to high doses of  $\beta$ -blockers [1]. As  $\beta$ -blockers constrict peripheral arterioles, peripheral artery disease can be aggravated.

ACE inhibitors and AR blockers may lead to substantial decreases in blood pressure and are also used for treatment of high blood pressure (see chapter “[Hypertension](#)”). Patients with advanced HF usually have hypotensive blood pressure, so general use and dosage of these drugs can be limited. Since angiotensin II is particularly important for the regulation of glomerular filtration pressure through vasoconstriction of the efferent glomerular arterioles (see chapter “[Overview](#)” under part “[Kidney](#)”), ACE inhibitors and AR blockers can result in a deterioration of renal function. Additionally, both drugs and aldosterone blockers may lead to an increase in potassium levels through their inhibition of aldosterone effects (see chapter “[Hypertension](#)”). This is a particular problem in patients with pre-existing renal dysfunction which is common in patients with advanced HF [1].

---

## Perspectives

New therapeutic concepts include interventions on an intracellular level to target signaling cascades associated with remodeling processes. One focus of current research is microRNAs, which are short noncoding RNAs that regulate gene expression at the posttranscriptional level. Antagonizing microRNAs regulating expression levels of genes responsible for remodeling processes [22] with RNA-interfering technologies might offer a new approach to modify remodeling.

Another new concept is gene therapy with intramyocardial transfer of genes, deficient in advanced HF. First clinical trials examining the delivery of SERCA2a gene show promising

results [23], and additional targets are under investigation such as adenylate cyclase and phospholamban [2].

An approach that is discussed controversially is myocardial regeneration therapy by stem cell transplantation with the aim to replace CMs lost to ischemia [24].

Overall, the prevalence of HF is projected to further increase during the next 20 years [25]. This is the result of demographic developments (increase of older individuals in the population), an increase in prevalence of risk factors such as diabetes and obesity, and improvements in treatment of myocardial infarction and initial HF such that more patients survive to the stage of advanced HF. According to the changing risk profiles, HFpEF will likely increase, and thus a treatment needs to be found [1].

## References

- McMurray JJ, Adamopoulos S, Anker SD, Auricchio A, Böhm M, Dickstein K, Falk V, Filippatos G, Fonseca C, Gomez-Sanchez MA, Jaarsma T, Køber L, Lip GY, Maggioni AP, Parkhomenko A, Pieske BM, Popescu BA, Rønnevik PK, Rutten FH, Schwitter J, Seferovic P, Stepinska J, Trindade PT, Voors AA, Zannad F, Zeiher A (2012) ESC Guidelines for the diagnosis and treatment of acute and chronic HF 2012: the Task Force for the Diagnosis and Treatment of Acute and Chronic HF 2012 of the European Society of Cardiology. Developed in collaboration with the Heart Failure Association (HFA) of the ESC. *Eur Heart J* 33:1787–1847
- Braunwald E (2013) Heart failure. *J Am Coll Cardiol HF* 1:1–20
- Jhund PS, MacIntyre K, Simpson CR, Lewsey JD, Stewart S, Redpath A, Chalmers JW, Capewell S, McMurray JJ (2009) Long-term trends in first hospitalization for HF and subsequent survival between 1986 and 2003: a population study of 5.1 million people. *Circulation* 119:515–523
- Mudd JO, Kass DA (2008) Tackling HF in the twenty-first century. *Nature* 451:919–928
- van Berlo JH, Mailliet M, Molkentin JD (2013) Signaling effectors underlying pathologic growth and remodeling of the heart. *J Clin Invest* 123:37–45
- Gandhi MS, Kamalov G, Shahbaz AU, Bhattacharya SK, Ahokas RA, Sun Y, Gerling IC, Weber KT (2011) Cellular and molecular pathways to myocardial necrosis and replacement fibrosis. *Heart Fail Rev* 16:23–34
- Gardner DG (2003) Natriuretic peptides: markers or modulators of cardiac hypertrophy? *Trends Endocrinol Metab* 14:411–416
- Whelan RS, Kaplinskiy V, Kitsis RN (2010) Cell death in the pathogenesis of heart disease: mechanisms and significance. *Annu Rev Physiol* 72:19–44
- Marks AR (2013) Calcium cycling proteins and HF: mechanisms and therapeutics. *J Clin Invest* 123:46–52
- El-Armouche A, Eschenhagen T (2009) Beta-adrenergic stimulation and myocardial function in the failing heart. *Heart Fail Rev* 14:225–241
- Aronson D, Krum H (2012) Novel therapies in acute and chronic HF. *Pharmacol Ther* 135:1–17
- Parissis JT, Rafouli-Stergiou P, Paraskevaidis I, Mebazaa A (2009) Levosimendan: from basic science to clinical practice. *Heart Fail Rev* 14:265–275
- Malik FI, Hartman JJ, Elias KA, Morgan BP, Rodriguez H, Brejc K, Anderson RL, Sueoka SH, Lee KH, Finer JT, Sakowicz R, Baliga R, Cox DR, Garard M, Godinez G, Kawas R, Kraynack E, Lenzi D, Lu PP, Muci A, Niu C, Qian X, Pierce DW, Pokrovskii M, Suehiro I, Sylvester S, Tochimoto T, Valdez C, Wang W, Katori T, Kass DA, Shen YT, Vatner SF, Morgans DJ (2011) Cardiac myosin activation: a potential therapeutic approach for systolic HF. *Science* 331:1439–1443
- Koitabashi N, Kass DA (2012) Reverse remodeling in HF—mechanisms and therapeutic opportunities. *Nat Rev Cardiol* 9:147–157
- Lowes BD, Gilbert EM, Abraham WT, Minobe WA, Larrabee P, Ferguson D, Wolfel EE, Lindenfeld J, Tsvetkova T, Robertson AD, Quaipe RA, Bristow MR (2002) Myocardial gene expression in dilated cardiomyopathy treated with beta-blocking agents. *N Engl J Med* 346:1357–1365
- Reiken S, Wehrens XH, Vest JA, Barbone A, Klotz S, Mancini D, Burkhoff D, Marks AR (2003) Beta-blockers restore calcium release channel function and improve cardiac muscle performance in human HF. *Circulation* 107:2459–2466
- Parati G, Esler M (2012) The human sympathetic nervous system: its relevance in hypertension and HF. *Eur Heart J* 33:1058–1066
- Lonn E, Shaikholeslami R, Yi Q, Bosch J, Sullivan B, Tanser P, Magi A, Yusuf S (2004) Effects of ramipril on left ventricular mass and function in cardiovascular patients with controlled blood pressure and with preserved left ventricular ejection fraction: a substudy of the Heart Outcomes Prevention Evaluation (HOPE) Trial. *J Am Coll Cardiol* 43:2200–2206
- Fraccarollo D, Galuppo P, Hildemann S, Christ M, Ertl G, Bauersachs J (2003) Additive improvement of left ventricular remodeling and neurohormonal activation by aldosterone receptor blockade with eplerenone and ACE inhibition in rats with myocardial infarction. *J Am Coll Cardiol* 42:1666–1673

20. Hayashi M, Tsutamoto T, Wada A, Tsutsui T, Ishii C, Ohno K, Fujii M, Taniguchi A, Hamatani T, Nozato Y, Kataoka K, Morigami N, Ohnishi M, Kinoshita M, Horie M (2003) Immediate administration of mineralocorticoid receptor antagonist spironolactone prevents post-infarct left ventricular remodeling associated with suppression of a marker of myocardial collagen synthesis in patients with first anterior acute myocardial infarction. *Circulation* 107: 2559–2565
21. Kapoor JR, Heidenreich PA (2012) Role of heart rate as a marker and mediator of poor outcome for patients with HF. *Curr Heart Fail Rep* 9:133–138
22. Topkara VK, Mann DL (2010) Clinical applications of miRNAs in cardiac remodeling and HF. *Per Med* 7:531–548
23. Jessup M, Greenberg B, Mancini D, Cappola T, Pauly DF, Jaski B, Yaroshinsky A, Zsebo KM, Dittrich H, Hajjar RJ (2011) Calcium upregulation by percutaneous administration of gene therapy in cardiac disease (CUPID): a phase 2 trial of intracoronary gene therapy of sarcoplasmic reticulum Ca<sup>2+</sup>-ATPase in patients with advanced HF. *Circulation* 124:304–313
24. Jeevanantham V, Butler M, Saad A, Abdel-Latif A, Zuba-Surma EK, Dawn B (2012) Adult bone marrow cell therapy improves survival and induces long-term improvement in cardiac parameters: a systematic review and meta-analysis. *Circulation* 126(5): 551–568
25. Heidenreich PA, Albert NM, Allen LA, Blumke DA, Butler J, Fonarow GC, Ikonomidis JS, Khavjou O, Konstam MA, Maddox TM, Nichol G, Pham M, Pina IL, Trogdon JG (2013) Forecasting the impact of HF in the United States: a policy statement from the American heart association. *Circ Heart Fail* 6:606–619

---

## Part XI

# Blood Vessels

---

## Overview

Victor W.M. van Hinsbergh, Rick Meijer,  
and Etto C. Eringa

---

### Anatomy and Physiology of Blood Vessels

The blood vessels conduct blood from the heart to the tissues and back, thus achieving continuous supply of oxygen and nutrients, removal of waste products, and – when needed – delivery of leukocytes to the organs. In one overall circulation cycle, the heart is passed two times in order to pump the blood through the other tissues and lungs (see chapter “[Overview](#)” under part “[Heart](#)”). Starting in the left ventricle of the heart, oxygenated blood flows into the systemic circulation through the aorta, and then into the large conduit arteries, which subsequently divide into smaller conduit arteries, resistance arteries, and the microcirculation. There, arterioles branch out into capillaries, the smallest blood vessels and site of solute and gas exchange. Capillaries merge into venules, and those merge into veins, conducting

the blood toward the right heart. From the right heart, blood flows into the pulmonary artery to enter the pulmonary circulation, where it is reoxygenated. The blood then returns to the left heart.

All large blood vessels are composed of three layers: the tunica intima, tunica media, and tunica adventitia. The intima of healthy arteries is mainly a continuous layer of endothelial cells (ECs), which prevents intravascular clotting of the blood, regulates fluid and solute transport from the blood to the tissues and back, and controls leukocyte recruitment and vascular tone [1]. The media consists of multiple layers of smooth muscle cells (SMCs) embedded in collagen, alternated by layers of elastin. The adventitia is a loose fibrous tissue that contains fibroblasts as well as small vessels (*vasa vasorum*) that nourish the outer cells of large arteries and can harbor leukocytes, mast cells, and mesenchymal stem cells. At its outside, it continues diffusely into a layer of perivascular adipose tissue (PVAT) that provides vasoregulatory adipokines to the arteries and arterioles (Fig. 1). In atherosclerotic arteries, the intima is thickened by accumulation of lipoproteins and lipid-laden cells underneath the endothelium (see chapter “[Atherosclerotic heart disease](#)”).

The aorta and large arteries are characterized by a thick layer of SMCs in their media, which maintains a rather constant blood pressure. The elasticity (windkessel function) of arteries helps not only to dampen the blood pulse generated by each heart beat but also – by recoil – to continue propelling the blood toward the tissues during diastole.

---

V.W.M. van Hinsbergh (✉) • E.C. Eringa  
Department for Physiology,  
Institute for Cardiovascular Research,  
VU University Medical Center,  
Van der Boechorststraat 7,  
Amsterdam 1081 BT, The Netherlands  
e-mail: [v.vanhinsbergh@vumc.nl](mailto:v.vanhinsbergh@vumc.nl); [e.eringa@vumc.nl](mailto:e.eringa@vumc.nl)

R. Meijer  
Department of Internal Medicine,  
Institute for Cardiovascular Research,  
VU University Medical Center,  
De Boelelaan, 7057,  
Amsterdam 1007 MB, The Netherlands  
e-mail: [r.meijer@vumc.nl](mailto:r.meijer@vumc.nl)

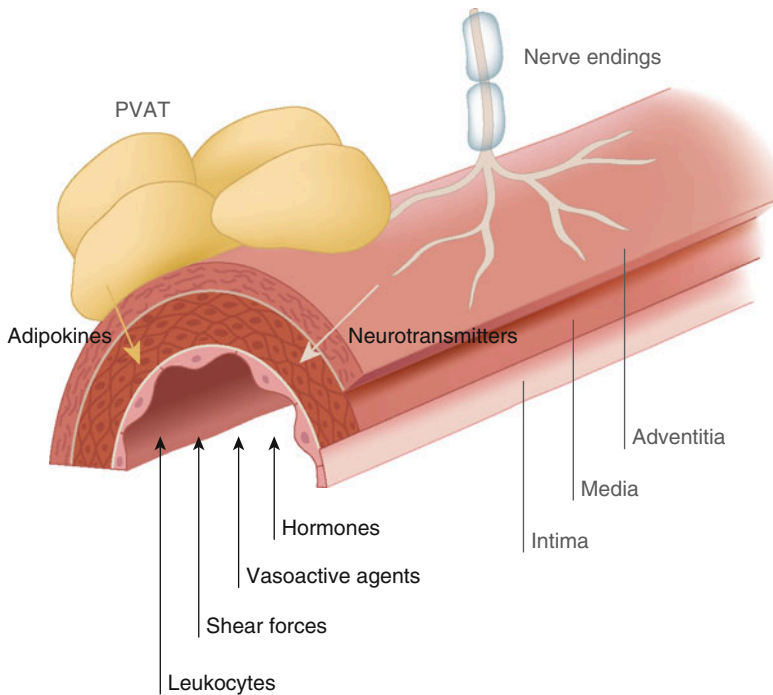

**Fig. 1** External mediators acting on blood vessels. The arterial wall consists of three main layers: the intima, which in healthy vessels mainly consists of the endothelium; the media that harbors concentric smooth muscle cells, alternated by collagen and elastin layers; and the adventitia. Many exogenous factors act on the wall of arteries. From the luminal side, hormones and vasoactive agents bind to cellular receptors and regulate the

interplay between endothelium and smooth muscle cells; shear forces influence the endothelial behavior; and leukocytes, platelets, and their products also interact with the vessel wall. From the outside, sympathetic nerve endings release neurotransmitters and the perivascular adipose tissue (PVAT) releases adipokines that contribute to vasoregulation

The small arteries and arterioles are the major site of resistance to blood flow. The collective diameter of all resistance vessels together is a main determinant of blood pressure (see chapter “[Hypertension](#)”), together with cardiac output. In addition to regulation of blood pressure, these “resistance vessels” determine and regulate the perfusion of the connected capillary bed, depending on the local demand, e.g., preferential perfusion through the skeletal muscle during exercise or to the splanchnic bed after meals. Neuronal factors, hormones, and tissue-derived paracrine factors modulate the perfusion of a tissue in order to meet its metabolic demand.

Delivery of oxygen and nutrients as well as removal of waste products occurs in the capillary bed [2], as the surface area of the capillary endothelium available for diffusion is large and transport distance from blood to the tissue is low. In most tissues, the capillary ECs are in

contact with pericytes and form a continuous endothelium. However, in specific tissues, such as liver and adrenal glands, they have large pores (so-called fenestrae) to allow rapid penetration of cholesterol-containing lipoproteins required for bile and steroid production, respectively. In contrast, in the brain, a tight endothelial barrier known as the blood-brain barrier is formed by interplay between endothelium, pericytes, and astrocyte foot ends [3]. However, upon a thrombotic stroke, the site distal to the occluded vessel becomes hypoxic and leaky (see chapter “[Stroke](#)”).

The walls of postcapillary venules, which collect the blood from the capillaries, consist of endothelium only and are the first to respond to vasoactive agents and noxious stimuli by temporarily allowing protein leakage to the interstitium and facilitating the first recruitment of phagocytes after injury or infection.

Walls of veins are considerably thinner than those of arteries, especially their media. Limb veins contain valves, facilitating conduction of the blood back toward the heart despite a low blood pressure. No valves are encountered in the smallest veins, the great collecting veins, and the veins of viscera and the brain. Veins are easily distended and contain the larger portion of blood in the circulatory system. In chronically overdistended veins in the legs, so-called varicose veins (see chapter “[Varicose veins](#)”), the valves are no longer competent to sustain blood movement toward the heart, and, subsequently, a higher pressure on the distal valves arises, creating a vicious cycle, eventually resulting in stasis and ankle edema.

---

### Inside-In: Paracrine Signals Acting Within the Vessel

SMC contraction occurs after stimulation of  $\text{Ca}^{2+}$  influx and subsequent activation of the enzyme myosin light chain (MLC) kinase [4]. The phosphorylated MLC initiates movement of myosin along F-actin fibers leading to cell contraction. MLC phosphatase activity undoes MLC phosphorylation and prevents contraction [4].

Many vasoactive agents, such as norepinephrine and substance P released from neurons (see below) and bradykinin (formed from a blood plasma protein), enhance cytoplasmic  $\text{Ca}^{2+}$  levels in SMCs leading to contraction, when applied to SMCs in the absence of endothelium. However, when a healthy endothelium is present, these vasoactive agents often also activate the endothelium prompting the generation of nitric oxide (NO) by endothelial NO synthase (eNOS), prostacyclin or prostaglandin E<sub>2</sub> via cyclooxygenase, and occasionally endothelium-derived hyperpolarization factor (Fig. 2a). These factors, of which NO is the most potent one, cause “endothelium-dependent” relaxation of SMCs. NO activates guanylate cyclase in SMCs and (the resulting) cGMP activates protein kinase G, which, among others, limits the influx of  $\text{Ca}^{2+}$  ions into the cytoplasm and subsequent contraction of SMCs [5]. Prostacyclin and prostaglandin E<sub>2</sub> cause elevation of cellular cAMP level, which by protein kinase A-mediated phosphorylation

and inhibition of myosin light chain kinase (MLCK) also leads to reduced actin-myosin interaction. In contrast, endothelin-1 is secreted by activated endothelium to stimulate vascular contraction (Fig. 2b).

The effects of NO and prostacyclin extend beyond SMC contraction. These mediators also reduce the activation and aggregation of blood platelets (Fig. 2). Furthermore, NO reduces inflammatory activation (see below) in the healthy arterial endothelium itself by interference with nuclear factor  $\kappa\text{B}$  signaling that is required for the transcription of inflammation-specific genes [6].

SMCs also respond to pressure and radial strain, directly. Prolonged changes in blood pressure can induce remodeling of SMCs and adaptation of the vessel diameter. Another physical factor that affects vascular functioning is vascular stiffening. Calcification due to deposition of calcium phosphate in arteries causes media stiffening in conduit arteries of elderly people, by which the vessel wall becomes less compliant. However, arterial stiffening can also be caused by formation of advanced glycation end products (see chapter “[Diabetes mellitus](#)”) that cross-link proteins within the vessel wall. Stiffening results in a reduced dampening of the pulse wave and thus a higher pulse pressure. This can promote vascular damage in brain and microvasculature of diabetic patients (see chapter “[Diabetes mellitus](#)”).

---

### Inside-Out: Vascular Factors Affecting Other Tissues

In addition to local vasoregulation, ECs in specific organs can also affect distant tissues by the conversion and catabolism of vasoactive agents [7]. In particular, the lung vasculature plays an important role through the production of angiotensin-converting enzyme (ACE), which converts angiotensin I into angiotensin II, thus influencing systemic blood pressure and volume via the renin-angiotensin-aldosterone-system (see chapter “[Overview](#)” under part “[Kidney](#)”). The lung vasculature also inactivates bradykinin, an important vasodilator, and takes up and degrades serotonin, a vasoconstrictor terminating their effects.



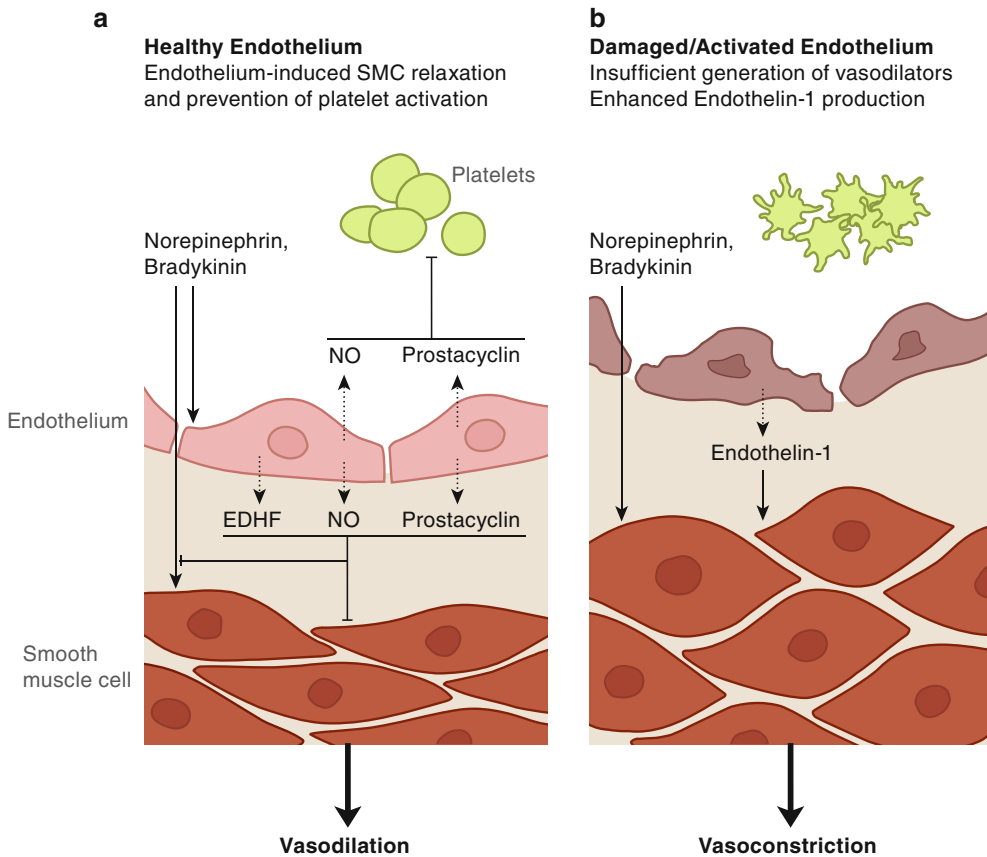

**Fig. 2** Paracrine interaction between endothelium and smooth muscle cells. **(a)** After stimulation with vasoactive agents or neural factors (e.g., norepinephrine and bradykinin), the healthy endothelium releases nitric oxide (NO), prostacyclin, and endothelium-derived hyperpolarization factor (EDHF), which counteract smooth muscle contraction by various intracellular mechanisms and therewith

contribute to vasodilation. Prostacyclin and NO also counteract platelet activation. **(b)** In disease, the production of these vasodilating agents can decrease, while production of the protein endothelin-1 can increase. Additionally, direct effects of vasoactive agents on smooth muscle cells are no longer suppressed, inducing vasoconstriction

The endothelium of healthy vessels produces several proteins that prevent thrombus formation (see chapter “[Overview](#)” under part “[Blood](#)”) [8]. It interrupts the coagulation cascade by providing antithrombin III that neutralizes thrombin and by thrombomodulin-facilitated activation of the anticoagulant protein C. It binds a metalloproteinase called ADAMTS13 that proteolytically cleaves von Willebrand factor multimers limiting platelet adhesion and activation. Furthermore, the endothelium reduces platelet activation and aggregation (Fig. 2a). Finally, it releases tissue-type plasminogen activator, a fibrinolysis-

catalyzing enzyme. These antithrombotic activities ensure undisturbed circulation. If the balance between pro- and antithrombotic/coagulant factors is disturbed, thrombus formation or bleeding will occur. While thrombus formation is required for limiting blood loss after wounding, it can also lead to adverse events, such as deep vein thrombosis or stroke (see chapter “[Stroke](#)”).

Inflammatory cells in atherosclerotic vessels (see chapter “[Atherosclerotic heart disease](#)”) produce cytokines, such as tumor necrosis factor- $\alpha$  (TNF- $\alpha$ ), that alter the properties of ECs. This results not only in a reduction of antithrom-

botic properties and activity of eNOS but also in the expression of leukocyte adhesion molecules, such as vascular cell adhesion molecule-1 and E-selectin, as well as chemo- and cytokines, such as monocyte chemoattractant protein-1 and interleukin-8 that stimulate influx of various leukocyte types [9]. Moreover, atherosclerotic arteries are associated with a subtle elevation of circulating C-reactive protein, reflecting a weak activation of the acute phase response in the liver (see chapter “[Overview](#)” under part “[Liver](#)”).

---

### **Outside-In: Factors from Other Tissues Affecting Conduit and Resistance Vessels**

Neural factors, such as norepinephrine and substance P, and hormones, such as epinephrine, insulin, and estrogen, are important regulators of vascular tone (Fig. 1). However, the effect of a specific factor can vary among the vascular beds of different organs because of different receptor isoforms, receptor sensitivities, or tissue-specific receptor distributions. In addition to primary effects on the vasculature, inflammatory cytokines and hypoxia can change gene expression in ECs [9]. Furthermore, shear stress by laminar flowing blood on arterial ECs causes a gene induction pattern within these cells that reduces inflammatory activation, while disturbance of the laminar flow pattern in arteries alters endothelial functioning and contributes to atherosclerotic lesion generation [10].

Hormones have to pass the endothelium to reach tissue cells and usually also act directly on blood vessels. In muscle or heart tissue, insulin has to pass the endothelium, while activating insulin receptors on the endothelium simultaneously. Insulin receptor activation in the proximal resistance vessels of tissues that store nutrients usually causes vasodilation by activation of eNOS via a pathway that involves insulin receptor substrate-1, phosphatidylinositol-3-kinase, and Akt (also called protein kinase B). In obesity, this effect is diminished, while endothelin-1 favors vascular contraction. Other hormones also

act on blood vessels. For example, estrogens interact with an endothelial membrane-bound estrogen receptor variant, which induces NO production and vasodilation (see chapter “[Overview](#)” under part “[Reproductive system](#)”) [11].

The vessel wall is approached not only from its luminal side by endocrine mediators but also from its outside by products of the surrounding PVAT acting in a paracrine fashion (Fig. 1). In obesity and type 2 diabetes (see chapters “[Metabolic syndrome](#)” and “[Diabetes mellitus](#)”, respectively), PVAT expands and becomes inflamed. While lean PVAT produces adipokines like adiponectin that facilitate vasodilation both in conduit arteries and insulin-stimulated resistance arteries, the expanded fatty PVAT loses this ability and shifts toward the production of nonesterified fatty acids, the pro-inflammatory cytokine TNF- $\alpha$ , leptin, and other factors that favor the contractile pathway induced by insulin [12]. These events affect, for example, the white adipose tissue and illustrate the mutual interrelationship between metabolism, inflammation, and vessel functioning.

---

### **Final Remarks**

Blood vessels distribute fuel for metabolism, control tissue perfusion by vasoregulation, and deliver tissue products and leukocytes to the sites where they are needed. Being critically important for the organism, blood vessels have a high capacity to adapt to various stresses and local needs. This can occur by short-term responses, such as acute adaptation of the vessel tone or release of factors that contribute to hemostasis, or by the induction of new genes, as in inflammation or hypoxia. Normally, this response is temporary. However, this adaptability can be overstretched by chronic activation or injury, leading to chronic or acute adverse responses. Within the book, three frequently encountered clinically relevant blood vessel-based diseases are covered: atherosclerosis (see chapter “[Atherosclerotic heart disease](#)”), stroke (see chapter “[Stroke](#)”), and varicose veins (see chapter “[Varicose veins](#)”).

## References

1. Aird WC (2007) Phenotypic heterogeneity of the endothelium: I. Structure, function, and mechanisms. *Circ Res* 100:158–173
2. Mehta D, Malik AB (2006) Signaling mechanisms regulating endothelial permeability. *Physiol Rev* 86:279–367
3. Armulik A, Genové G, Mäe M, Nisancioglu MH, Wallgard E, Niaudet C, He L, Norlin J, Lindblom P, Strittmatter K, Johansson BR, Betsholtz C (2010) Pericytes regulate the blood-brain barrier. *Nature* 468:557–561
4. Somlyo AP, Somlyo AV (2003) Ca<sup>2+</sup> sensitivity of smooth muscle and nonmuscle myosin II: modulated by G proteins, kinases, and myosin phosphatase. *Physiol Rev* 83:1325–1358
5. Bian K, Doursout MF, Murad F (2008) Vascular system: role of nitric oxide in cardiovascular diseases. *J Clin Hypertens (Greenwich)* 10:304–310
6. De Caterina R, Libby P, Peng HB, Thannickal VJ, Rajavashisth TB, Gimbrone MA Jr, Shin WS, Liao JK (1995) Nitric oxide decreases cytokine-induced endothelial activation. Nitric oxide selectively reduces endothelial expression of adhesion molecules and proinflammatory cytokines. *J Clin Invest* 96:60–68
7. Fishman AP (1982) Endothelium: a distributed organ of diverse capabilities. *Ann N Y Acad Sci* 401:1–8
8. VWM van Hinsbergh (2012) Endothelium – role in regulation of coagulation and inflammation. *Semin Immunopathol* 34:93–106
9. Pober JS, Sessa WC (2007) Evolving functions of endothelial cells in inflammation. *Nat Rev Immunol* 7:803–815
10. Davies PF (2009) Hemodynamic shear stress and the endothelium in cardiovascular pathophysiology. *Nat Clin Pract Cardiovasc Med* 6:16–26
11. Mendelsohn ME, Karas RH (2010) Rapid progress for non-nuclear estrogen receptor signaling. *J Clin Invest* 120:2277–2279
12. Aghamohammadzadeh R, Withers S, Lynch F, Greenstein A, Malik R, Heagerty A (2012) Perivascular adipose tissue from human systemic and coronary vessels: the emergence of a new pharmacotherapeutic target. *Br J Pharmacol* 165:670–682

---

# Stroke

Dwi Setyowati Karolina and Kandiah Jeyaseelan

---

## Introduction to Stroke

Stroke is a cerebrovascular disease characterized by rapid loss in brain function due to obstruction in the blood supply to the brain. According to the World Health Organization, over 15 million first-time stroke incidents occur worldwide, killing or permanently disabling ten million people annually, thus resulting in tremendous socioeconomic burden due to costly palliative care.

Ischemic stroke, accounting for >80 % of all cases, occurs when the afferent vasculature to the brain is occluded by local arteriosclerosis and/or by a local or a moving thrombus [1]. Hemorrhagic stroke (~15 % of the cases) occurs when the blood vessel ruptures and bleeds into the brain [2]. Stroke is a medical emergency because the brain tissue ceases to function within minutes of oxygen deprivation and infarction occurs as the cells die, causing an irreversible injury (necrosis) at the core of the infarct surrounded by recoverable tissue damage (apoptosis) at the penumbra. Activation of inflammatory cells causes the release of cytokines, matrix metalloproteinases, and reactive oxygen species eventually leading to

blood-brain barrier (BBB) breakdown and cerebral edema [3].

In hemorrhagic strokes, edema is induced by the buildup of pressure in the cranium due to internal bleeding. Upon red blood cell lysis, hemoglobin is degraded into iron, carbon monoxide, and biliverdin. Carbon monoxide and iron can cause tissue damage via the formation of free radicals. Altogether, hemoglobin and its degradation products may exacerbate brain edema [4].

Risk factors of stroke include hypertension, hypercholesterolemia, and hyperglycemia, as these can exert stress on the walls of the blood vessels causing them to thicken, forming plaques on the arterial walls and narrowing them further. These plaques could break away and occlude the cerebral blood vessels resulting in stroke. Chronic hypertension may weaken the vasculature leading to rupture and hemorrhagic stroke (see chapter “[Hypertension](#)”).

---

## Pathological Changes in Metabolism Following Stroke Onset

Reduced cerebral blood flow exerts a direct effect on the cerebral metabolism. During the early phase of acute ischemic stroke, an inflammatory response is initiated alongside leukocyte activation. Leukocyte influx (neutrophils in particular) induces release of destructive enzymes and pro-inflammatory cytokines with neurotoxic effects resulting in hyperthermia [5]. Hyperthermia in the brain augments the tissue’s metabolic rate

---

D.S. Karolina • K. Jeyaseelan (✉)  
Department of Biochemistry and Centre  
for Translational Medicine,  
Yong Loo Lin School of Medicine,  
National University of Singapore,  
14 Medical Drive, Singapore 117599, Singapore  
e-mail: [bchkds@nus.edu.sg](mailto:bchkds@nus.edu.sg);  
[kandiah\\_jeyaseelan@nuhs.edu.sg](mailto:kandiah_jeyaseelan@nuhs.edu.sg)

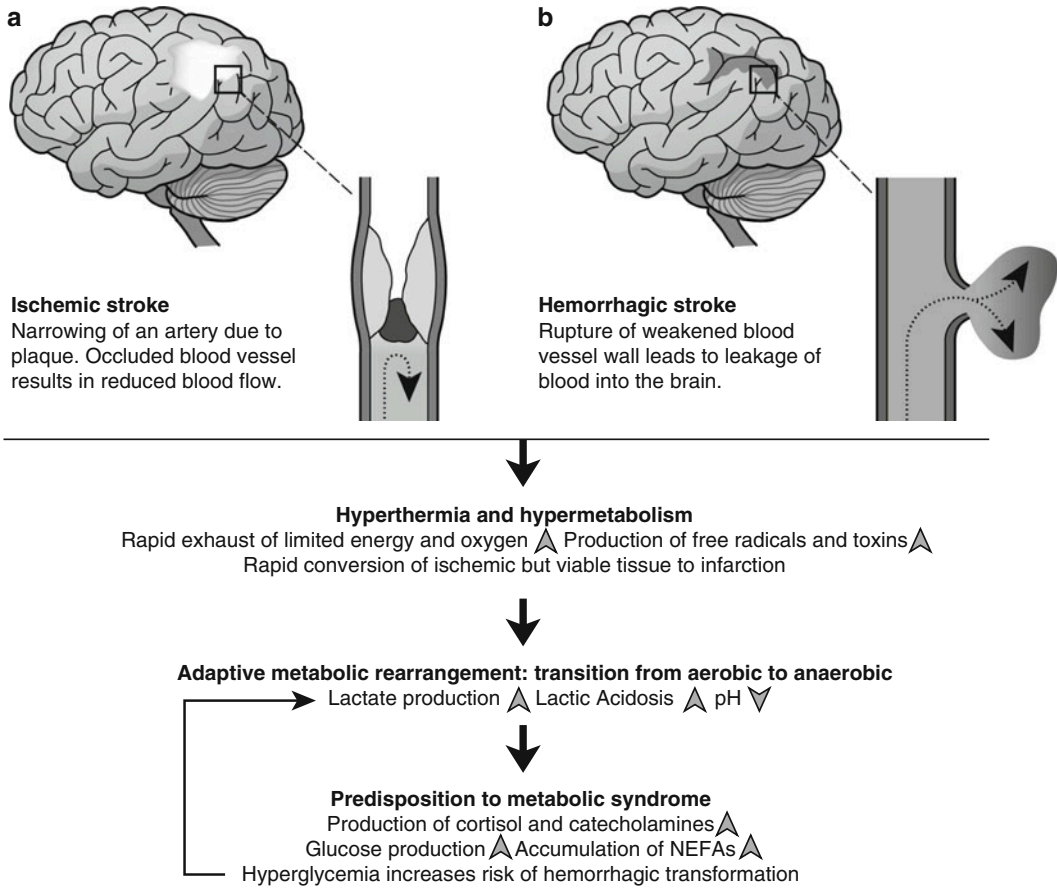

**Fig. 1** (a, b) Metabolic effects of stroke. *NEFA* nonesterified fatty acids

(hypermetabolism), causing rapid exhaustion of the limited energy and oxygen supplies, increased production of free radicals and toxic substances such as glutamate, and  $\text{Ca}^{2+}$  overload, thereby advancing the conversion of ischemic but viable tissue to infarction (Fig. 1) [6]. Oxygen deprivation induces anaerobic cerebral glycolysis, and the increased lactate production serves as a (clinical) marker of energy failure and the degree of damage [7]. Chronic lactate production leads to lactic acidosis and reduced extracellular pH, which are detrimental to the brain. Nevertheless, it was suggested that glucose rather than lactate in combination with acidosis is the main culprit that aggravates brain damage during stroke [7]. Glucose toxicity could be mediated via formation of advanced glycation end products (see chapter “Diabetes mellitus”), which may cause protein

dysfunction or enhance oxidative stress [8]. In fact, cerebral hyperglycolytic lactate production may indicate increased alternative energy substrate usage and is now emerging as a good rather than bad marker indicating favorable long-term recovery [9].

Specific neuronal circuitry perceives the metabolic status of peripheral tissues via hormones (e.g., leptin, insulin, and ghrelin) as well as through direct macronutrient sensing. The center of these brain networks is localized within the mediobasal hypothalamus interconnected with brainstem areas and the mesolimbic reward circuitry [10]. Disruption of brain activity impairs these networks thereby affecting regulatory control over glucose metabolism. A high proportion of stroke patients develop hyperglycemia even in the absence of preexisting diabetes [11]. During

stroke, excitotoxicity due to excess glutamate, inflammation, as well as release of free radicals induce stress to the cells. In response to this, the hypothalamic-pituitary-adrenal system (see chapter “[Overview](#)” under part “Brain”) triggers the release of neurohormones such as cortisol and catecholamines [12]. This in turn promotes glycogenolysis and gluconeogenesis in the liver while inhibiting insulin sensitivity and glucose uptake in the skeletal muscle [13]. They also stimulate lipolysis, resulting in accumulation of nonesterified fatty acids [13]. Hyperglycemia fuels anaerobic metabolism, lactic acidosis, and free radical production, which then exert direct membrane lipid peroxidation and cell lysis in the metabolically challenged tissues [14]. Such positive feedback leads to a further derangement in pH homeostasis, which can trigger the production of free radicals and affects the  $\text{Ca}^{2+}$  balance in neurons, possibly resulting in neuronal cell death [15]. These free radicals can cause functional and morphological changes to the endothelium, thus increasing permeability of the BBB, edema formation, as well as risk of hemorrhagic transformation.

---

## Treatment of Strokes

Thrombolytic drugs such as alteplase and reteplase, which are synthetic enzymes with similar function to the endogenously produced tissue plasminogen activator (tPA), are the first line of treatment against ischemic stroke [16]. tPA is a serine protease found on vascular endothelial cells and is involved in the lysis of blood clots (see chapter “[Overview](#)” under part “Blood”). Although thrombolysis can improve blood flow, these clot-dissolving drugs are only effective within 4.5 h of stroke onset, after which they pose increased risk of hemorrhage. Hence, patients with hemorrhagic stroke or severely elevated blood pressure are not eligible for such treatment. A more invasive procedure, mechanical thrombectomy, may be performed to remove or break up the clot [17]. An alternative mechanical approach is the Penumbra System, an embolectomy device specifically

designed to remove clots by aspiration and extraction [17]. Treatment for hemorrhagic stroke aims to stop the bleeding by surgical clipping (closing the base of a leakage or aneurysm by constriction) or endovascular coiling (insertion of a metallic coil into the site of leakage followed by blood clotting) and to drain the blood (hematoma) that has accumulated in the brain [18]. Apart from these, stroke treatment also involves medications that control inflammation, brain swelling, blood pressure, hyperglycemia, and hypercholesterolemia (Table 1).

---

## Influence of Treatment on Metabolism

Early phase damage in the brain can be reversed when the disrupted blood flow is restored in time by medical interventions. Yet, reperfusion at the ischemic region can activate astrocytes, microglia, and endothelial cells to produce cytokines and chemokines, which are potent mediators of inflammatory responses. This results in activation of matrix metalloproteinases, which disrupt the BBB by digesting extracellular matrix proteins within the basal lamina, such as type IV collagen, laminin, and fibronectin. This consequently causes BBB disruption, edema formation, and hemorrhagic transformation [19].

## Secondary Treatment Options

The majority of stroke patients have a combination of medical disorders such as hypertension (see chapter “[Hypertension](#)”), dyslipidemia (see chapter “[Hyperlipidemia](#)”), and diabetes (see chapter “[Diabetes mellitus](#)”). Hence, treatment for stroke also includes the management of these conditions. Antihypertensive drugs such as thiazide diuretics and  $\text{Ca}^{2+}$  channel blockers are prescribed to control blood pressure by reducing blood volume, systemic vascular resistance, and cardiac output (see chapter “[Hypertension](#)”). Cholesterol-lowering drugs such as statins are used to control cholesterol synthesis in the liver (see chapter “[Hyperlipidemia](#)”).

**Table 1** Effects of stroke treatments

Immediate treatment for ischemic stroke	Immediate treatment for hemorrhagic stroke
Thrombolytic drugs Alteplase, reteplase, tenecteplase Anistreplase, streptokinase, urokinase  Surgical approaches MERCİ retriever Penumbra system Advantages: restoration of blood flow Disadvantages: reperfusion induces inflammatory response and increases risk of hemorrhagic transformation	Surgical approaches Surgical clipping Endovascular coiling Evacuation of hematoma  Advantages: stops bleeding Disadvantages: risk of death during procedures
Prescribed medications to prevent recurring stroke/complications	
Anticoagulant or antiplatelet Prevents blood clotting Platelet aggregation ✓ Inhibits thrombus formation Antihypertensive drugs Blood volume ✓ Systemic vascular resistance ✓ Cardiac output ✓ Cholesterol-lowering drugs Cholesterol synthesis in liver also have antihypertensive effects ✓ Antihyperglycemic drugs Insulin therapy maintains strict glycemic control and improves blood circulation to the ischemic areas Improved prognosis	

Insulin therapy is usually recommended for treating hyperglycemia in stroke patients. Besides lowering blood glucose levels, insulin also exerts antioxidant and anti-inflammatory effects by suppressing several proinflammatory transcription factors, such as nuclear factor- $\kappa$ B, early growth response protein 1, and activator protein 1, as well as generation of reactive oxygen species, thereby minimizing stroke complications [20]. Moreover, insulin therapy has also been shown to significantly reduce systolic blood pressure and improve stroke outcome [20].

## Perspectives

Pathogenesis of stroke involves multiple factors, which coordinately impair the metabolic status of the body. Recombinant or artificial tPAs, the only therapeutic arsenal available today, have several limitations such as short therapeutic window and the risk of hemorrhagic transformation. Even recombinant tPA therapy in combination with

other drugs to reduce stroke complications is not always effective, and novel therapeutic agents are necessary.

Recently, microRNAs (miRNAs) have gained attention in translational stroke research [21]. These endogenous gene regulators target several metabolic and biological processes that are impaired in pathological conditions. For instance, miR-320, a key player in edema formation, is upregulated in stroke conditions [22]. Hence, downregulation of miR-320 expression has been associated with favorable outcomes in stroke patients [23]. However, more and extensive studies are needed before miRNAs could reach clinical trials in stroke therapy. Yet, the development of miRNAs as multi-target drugs holds great potential.

## References

1. Hademenos GJ, Massoud TF (1997) Biophysical mechanisms of stroke. *Stroke* 28:2067–2077
2. Qureshi AI, Mendelow AD, Hanley DF (2009) Intracerebral haemorrhage. *Lancet* 373:1632–1644



3. Danton GH, Dietrich WD (2003) Inflammatory mechanisms after ischemia and stroke. *J Neuropathol Exp Neurol* 62:127–136
4. Hua Y, Keep RF, Hoff JT, Xi G (2007) Brain injury after intracerebral hemorrhage: the role of thrombin and iron. *Stroke* 38:759–762
5. Zaremba J (2004) Hyperthermia in ischemic stroke. *Med Sci Monit* 10:RA148–RA153
6. Karaszewski B, Wardlaw JM, Marshall I, Cvoro V, Wartolowska K, Haga K, Armitage PA, Bastin ME, Dennis MS (2009) Early brain temperature elevation and anaerobic metabolism in human acute ischaemic stroke. *Brain* 132:955–964
7. Valenza F, Aletti G, Fossali T, Chevillard G, Sacconi F, Irace M, Gattinoni L (2005) Lactate as a marker of energy failure in critically ill patients: hypothesis. *Crit Care* 9:588–593
8. Kikuchi S, Shinpo K, Takeuchi M, Yamagishi S, Makita Z, Sasaki N, Tashiro K (2003) Glycation: a sweet tempter for neuronal death. *Brain Res Brain Res Rev* 4:306–323
9. Oddo M, Levine JM, Frangos S, Maloney-Wilensky E, Carrera E, Daniel RT, Levivier M, Magistretti PJ, LeRoux PD (2012) Brain lactate metabolism in humans with subarachnoid hemorrhage. *Stroke* 43:1418–1421
10. Farooqui AA, Farooqui T, Panza F, Frisardi V (2012) Metabolic syndrome as a risk factor for neurological disorders. *Cell Mol Life Sci* 69:741–762
11. Melamed E (1976) Reactive hyperglycaemia in patients with acute stroke. *J Neurol Sci* 29:267–275
12. Anne M, Juha K, Timo M, Mikko T, Olli V, Kyösti S, Heikki H, Vilho M (2007) Neurohormonal activation in ischemic stroke: effects of acute phase disturbances on long-term mortality. *Curr Neurovasc Res* 4:170–175
13. Zafari AM, Wang SS, Song Q (2006) Genetics of metabolic syndrome. *Clin Rev* pp. 51–61. [www.turner-white.com/pdf/hp\\_oct06\\_genetic.pdf](http://www.turner-white.com/pdf/hp_oct06_genetic.pdf)
14. Lindsberg PJ, Roine RO (2004) Hyperglycemia in acute stroke. *Stroke* 35:363–364
15. Orłowski P, Chappell M, Park CS, Grau V, Payne S (2011) Modelling of pH dynamics in brain cells after stroke. *Interface Focus* 6:408–416
16. The National Institute of Neurological Disorders and Stroke rt-PA Stroke Study Group (1995) Tissue plasminogen activator for acute ischemic stroke. *N Engl J Med* 333:1581–1587
17. Tenser MS, Amar AP, Mack WJ (2011) Mechanical thrombectomy for acute ischemic stroke using the MERCI retriever and penumbra aspiration systems. *World Neurosurg* 76:S16–S23
18. Lapchak PA, Araujo DM (2007) Advances in hemorrhagic stroke therapy: conventional and novel approaches. *Expert Opin Emerg Drugs* 12:389–406
19. Visse R, Nagase H (2003) Matrix metalloproteinases and tissue inhibitors of metalloproteinases: structure, function, and biochemistry. *Circ Res* 92:827–839
20. Garg R, Chaudhuri A, Munschauer F, Dandona P (2006) Hyperglycemia, insulin, and acute ischemic stroke: a mechanistic justification for a trial of insulin infusion therapy. *Stroke* 37:267–273
21. Tan JR, Koo YX, Kaur P, Liu F, Armugam A, Wong PT, Jeyaseelan K (2011) microRNAs in stroke pathogenesis. *Curr Mol Med* 11:76–92
22. Sepramaniam S, Armugam A, Lim KY, Karolina DS, Swaminathan P, Tan JR, Jeyaseelan K (2010) MicroRNA 320a functions as a novel endogenous modulator of aquaporins 1 and 4 as well as a potential therapeutic target in cerebral ischemia. *J Biol Chem* 285:29223–29230
23. Tan KS, Armugam A, Sepramaniam S, Lim KY, Setyowati KD, Wang CW, Jeyaseelan K (2009) Expression profile of MicroRNAs in young stroke patients. *PLoS One* 4:e7689

---

# Varicose Veins

Rishi Mandavia, Muzaffar A. Anwar,  
and Alun H. Davies

---

## Introduction to Varicose Veins

Varicose veins are characterized by tortuous and dilated veins that are incompetent in terms of their ability to pump venous blood in sufficient amounts back to the heart. The disease mainly affects the lower limbs [1]. Varicose veins can cause significant morbidity and negatively impact quality of life [2]. Symptoms include pain, heaviness, aching, swelling, restless legs, cramps, and itching. Complications of varicose veins include bleeding and skin changes including lipodermatosclerosis (an inflammation of the fat layer below the epidermis) and ulceration [1]. The etiology of varicose veins is unclear. Our current understanding is that varicose veins are a manifestation of chronic venous insufficiency (CVI), whereby return of venous blood is impaired owing to calf muscle pump failure (i.e., the ability to press venous blood toward the heart via calf muscle contractions), venous obstruction, or reflux. This causes an increase in venous blood pressure resulting in swelling of the leg and the cutaneous manifestations characteristic of this condition [3]. Risk factors for varicose veins include female sex, obesity,

pregnancy, positive family history, prolonged standing, and a past history of deep vein thrombosis. The reported incidence of varicose veins is variable, ranging from 2 to 56 % in men and 1 to 73 % in women [4]. Diagnosis is clinical, reliant on clinical history and examination. The gold standard imaging technique is color duplex ultrasound enabling assessment of the deep and superficial venous systems.

The treatment of varicose veins accounts for approximately 2 % of the National Health Service (NHS) budget [1], while the population-based costs for treatment of chronic venous insufficiency (in the United States) have been estimated at \$3 billion per year [5, 6], underlining their significant socioeconomic burden.

---

## Pathophysiology of Varicose Veins and Metabolic Alterations

The pathogenesis of varicose vein formation is complex and likely multifactorial. Hemodynamic disturbances play a significant role in its development. Venous valve failure has been considered a primary cause in disease development and can result in blood stasis and venous hypertension. Hemodynamic disturbances generating mechanical stretch and hypoxia of the vein wall subsequently induce venous wall remodeling, which is characterized by pathological changes in all three wall layers (see chapter “Overview” under part “Blood vessels”) [7].

---

R. Mandavia • M.A. Anwar • A.H. Davies (✉)  
Academic Section of Vascular Surgery,  
Imperial College London, Charing Cross Hospital,  
Fulham Palace Road, London W6 8RF, UK  
e-mail: [rishimandavia@gmail.com](mailto:rishimandavia@gmail.com);  
[m.anwar@imperial.ac.uk](mailto:m.anwar@imperial.ac.uk); [a.h.davies@imperial.ac.uk](mailto:a.h.davies@imperial.ac.uk)

**Fig. 1** Possible relation of genetic and environmental factors and molecular changes in varicose veins development. *HIF* hypoxia-inducible factor, *MMPs* matrix metalloproteinases, *TIMPs* tissue inhibitors of metalloproteinases, *ECM* extracellular matrix, *TGF* transforming growth factor, *VEGF* vascular endothelial growth factor, *EC* endothelial cell, *SMC* smooth muscle cell

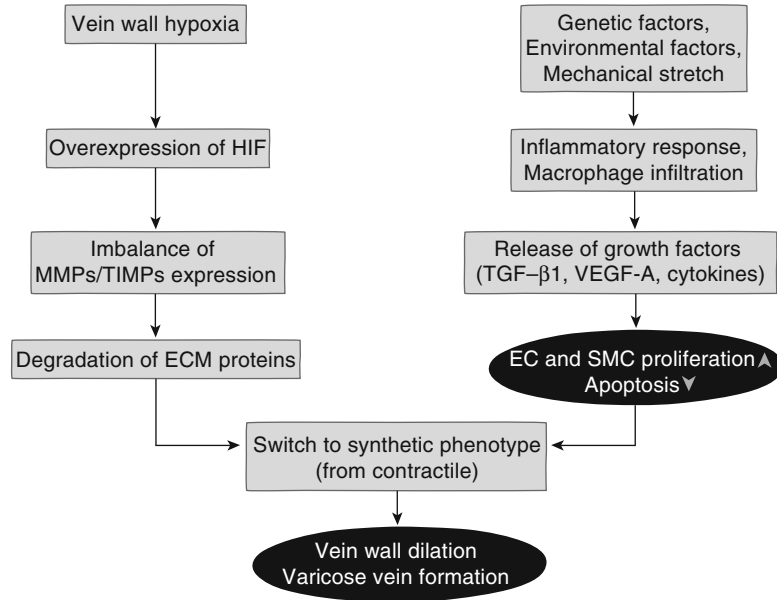

## Histological Changes

The histological changes involving the intimal layer include endothelial cell hyperplasia associated with collagen deposits, vascular smooth muscle cell (SMC) infiltration, and plaques consisting mainly of macrophages, SMCs, and triglycerides underneath the endothelial lining. Abnormal changes reported in medial and adventitial layers are SMC proliferation, extracellular matrix degradation, increased proliferation of fibroblasts, and connective tissues with regions of atrophy and loss of vasa vasorum (see chapter “[Overview](#)” under part “[Blood vessels](#)”) [8]. Inflammation, reduced apoptosis, imbalance of matrix metabolism, as well as growth factor dysregulation have also been reported in varicose vein walls [1].

## Molecular Changes

Increased levels of cytokines and chemotactic activity with infiltration of monocytes and macrophages have been observed in varicose vein walls (see chapter “[Atherosclerotic heart disease](#)” and Fig. 1) [9]. These inflammatory cells release proteases, which remodel the extracellular matrix

[10]. Macrophages also release growth factors such as vascular endothelial growth factor-A and transforming growth factor- $\beta$ 1, which increase endothelial and vascular SMC proliferation [11]. This results in a change in phenotype of vascular SMCs from a contractile phenotype to a synthetic one. A synthetic phenotype is characterized by loss of contractile actin cytoskeleton and loss of myosin as well as increased vacuolization and phagocytosis [12, 13]. Apoptosis is also inhibited in varicose vein walls, with a simultaneous increase in proliferative activity [14].

Vein wall hypoxia secondary to blood stasis has been postulated to contribute to varicose vein wall changes, based on studies demonstrating that average minimum oxygen tensions are significantly lower in varicose as compared to non-varicose veins [15]. Moreover, varicose veins have been shown to activate the hypoxia-inducible factor pathway via protracted elevation in venous pressure and vein wall stretch [16].

Disruption in extracellular matrix constituents leads to the weakening and dilatation of vein walls [17]. Imbalances of matrix metalloproteinases (MMPs), zinc-dependent endopeptidases, and their endogenous tissue inhibitors (TIMPs) have also been observed in varicose veins [18]. Further, significantly increased concentrations of

pro-matrix metalloproteinase-9 (pro-MMP9) and L-selectin released from leukocytes have been demonstrated in blood samples from varicose compared to non-varicose veins after postural blood stasis [19]. The imbalance of proteinases and inhibitors (see also chapter “Osteoarthritis”) in favor of proteinases, as well as reduced content and arrangement of elastin and increased in collagen type I and loss of collagen type III fibers, is likely to weaken the vein wall and cause dilatation.

### Metabolic Changes

There are very few studies, which have demonstrated direct metabolic changes in the varicose vein wall. Importantly, characteristic distribution of lipid metabolites including phosphatidylcholine, lysophosphatidylcholine, and sphingomyelin has been observed around damaged valvular regions and in the dilated vein wall [20]. Further, a significantly reduced number of lymphatic vessels around varicose veins may be responsible for this lipid accumulation and subsequent vein wall degeneration [20].

Nuclear magnetic resonance (NMR) spectroscopy (a method of studying metabolic perturbation in tissues and body fluids) revealed significantly higher levels of lactate, creatine, and myoinositol in the varicose vein wall compared to control veins [21]. The different metabolites reflect the underlying metabolic changes in the varicose vein wall. Whereas creatine and its metabolites correlate with SMC hypertrophy, high levels of lactate convey the hypoxic state of the varicose vein wall. Myoinositol, a constituent of second messengers, is involved in cell signaling, which eventually results in cell proliferation [21].

---

### Treatment of Varicose Veins

Compression hosiery is the first-line treatment option. Treatment is noninvasive but patients can find compression hosiery uncomfortable, expensive, unsightly, and difficult to apply [22].

About 60–70 % of patients with varicose veins have incompetent saphenofemoral junctions (located at the inguinal region) with reflux in the long saphenous system. Therefore, surgical or endovenous treatments are tailored toward treating the reflux. Open surgery involves high tie or saphenofemoral ligation followed by the removal of the varicose long saphenous vein. Sclerotherapy, i.e., injection of a sclerosant into the varicose veins to make them shrink, has been found to be particularly effective [23]. The two most commonly used endovenous treatments include radiofrequency ablation and endovenous laser ablation. These treatments work by providing a method of delivering thermal energy to the venous endothelium, subsequently sealing the incompetent veins, thus favoring flow to alternative, more competent veins. Technical success and recurrence rates are comparable to open surgery. The pertinent complications of surgical and endovenous treatments include bleeding, infection, nerve damage, skin pigmentation, deep vein thrombosis, and recurrence.

---

### Pharmacological Treatments and Their Influence on Metabolism

Varicose vein recurrence rates following surgical intervention range between 20 and 40 % [24]. Existing pharmacological treatment is mainly symptomatic focusing on edema, pain, and itchiness. The pharmacological intervention of venous disease can be classified into venoactive or non-venoactive. The precise mechanism of venoactive drugs is not fully known; however, they are suspected to improve venous tone and target the microcirculatory changes induced by chronic venous hypertension, such as leukocyte activation and inflammatory cytokine release, increased capillary permeability, and proteolysis [25].

Micronized purified flavonoid fraction or flavonoids containing 90 % diosmin and 10 % hesperidin (two flavonoids mainly found in citrus fruits) are the most studied venoactive agents. Treatment has resulted in significant improvements in health-related quality of life, objective

**Table 1** Pharmacological treatments, including main components and mechanisms of action

Treatment	Main component	Mechanism of action
Micronized purified flavonoid fraction	Diosmin and hesperidin	Prevents venous wall hypoxia Venous tone $\Delta$ Expression of adhesion molecules $\nabla$
Horse chestnut seed extract	Escin	Platelet aggregation $\nabla$ Augments lymphatic drainage
Pycnogenol	Flavanol	Anti-inflammatory Platelet aggregation $\nabla$ Vasodilator Antioxidant
Mesoglycan	Glycosaminoglycan	Restores negative cell surface charge of vascular endothelium after damage
Calcium dobesilate	Dobesilic acid	Antioxidant Capillary permeability $\nabla$ Venous tone $\Delta$

symptom scores, as well as leg edema. Their hypothesized mechanism of action is to prevent venous wall hypoxia, inhibit the expression of certain adhesion molecules on the endothelium, and increase venous tone [25, 26]. Horse chestnut seed extract is a herbal remedy, the active component of which is escin (a mixture of amphipathic glycosides). Horse chestnut seed extract has been found to improve leg pain, edema, and pruritus (itching) [27]. It appears to work by inhibiting platelet aggregation and augmenting lymphatic drainage, with mechanism of action likely related to inhibition or reduced expression of MMP-9, lipoxygenase, and COX-2 [22].

Compounds such as Pycnogenol<sup>®</sup>, a flavanol that suppresses endothelin-1, which normally constricts blood vessels (see chapter “[Overview](#)” under part “Blood vessels”), and Mesoglycan, a glycosaminoglycan (GAG) mixture, which restores the negative cell surface charge of vascular endothelium after damage, have both been considered for symptoms control [28].

Calcium dobesilate is a venoactive synthetic agent with antioxidant properties that reduces capillary permeability while increasing venous tone. It has been found to significantly improve pain, heaviness, and swelling in venous disease; however, some doubts exist on its safety [26] (Table 1).

## Perspectives

Currently, surgery seems to be the optimal long-term strategy for varicose vein treatment. However, surgical strategies and their complications are expensive and a large proportion of patients (particularly the elderly) increasingly opt against invasive surgical intervention, preferring minimally invasive or medical management instead.

Therefore, pharmacological treatment of varicose veins is an attractive therapeutic option for the future. Identifying the genetic and molecular bases for varicose veins can highlight individuals at risk and outline possible targets for pharmacological interventions or genetic manipulation of the disease.

## References

1. Lim CS, Davies AH (2009) Pathogenesis of primary varicose veins. *Br J Surg* 96:1231–1242
2. Darvall KA, Bate GR, Adam DJ, Bradbury AW (2012) Generic health-related quality of life is significantly worse in varicose vein patients with lower limb symptoms independent of CEAP clinical grade. *Eur J Vasc Endovasc Surg* 44:341–344
3. Raffetto JD, Khalil RA (2008) Mechanisms of varicose vein formation: valve dysfunction and wall dilation. *Phlebology* 23:85–98

4. Scott TE, LaMorte WW, Gorin DR, Menzoian JO (1995) Risk factors for chronic venous insufficiency: a dual case-control study. *J Vasc Surg* 22:622–628
5. Meissner MH, Gloviczki P, Bergan J, Kistner RL, Morrison N, Pannier F, Pappas PJ, Rabe E, Raju S, Villavicencio JL (2007) Primary chronic venous disorders. *J Vasc Surg* 46:54S–67S
6. Brake M, Lim CS, Shepherd AC, Shalhoub J, Davies AH (2013) Pathogenesis and etiology of recurrent varicose veins. *J Vasc Surg* 57:860–868
7. Anwar MA, Shalhoub J, Lim CS, Gohel MS, Davies AH (2012) The effect of pressure-induced mechanical stretch on vascular wall differential gene expression. *J Vasc Res* 49:463–478
8. Somers P, Knaapen M (2006) The histopathology of varicose vein disease. *Angiology* 57:546–555
9. Kakkos SK, Zolota VG, Peristeropoulou P, Apostolopoulou A, Geroukalos G, Tsolakis IA (2003) Increased mast cell infiltration in familial varicose veins: pathogenetic implications? *Int Angiol* 22:43–49
10. Yamada T, Tomita S, Mori M, Sasatomi E, Suenaga E, Itoh T (1996) Increased mast cell infiltration in varicose veins of the lower limbs: a possible role in the development of varices. *Surgery* 119:494–497
11. Jacob T, Hingorani A, Ascher E (2005) Overexpression of transforming growth factor-beta1 correlates with increased synthesis of nitric oxide synthase in varicose veins. *J Vasc Surg* 41:523–530
12. Cario-Toumaniantz C, Boularan C, Schurgers LJ, Heymann MF, Le Cunff M, Léger J, Loirand G, Pacaud P (2007) Identification of differentially expressed genes in human varicose veins: involvement of matrix gla protein in extracellular matrix remodeling. *J Vasc Res* 44:444–459
13. Wali MA, Eid RA (2001) Smooth muscle changes in varicose veins: an ultrastructural study. *J Smooth Muscle Res* 37:123–135
14. Ascher E, Jacob T, Hingorani A, Tsemekhin B, Gunduz Y (2001) Expression of molecular mediators of apoptosis and their role in the pathogenesis of lower-extremity varicose veins. *J Vasc Surg* 33:1080–1086
15. Lim CS, Gohel MS, Shepherd AC, Paleolog E, Davies AH (2010) Venous hypoxia: a poorly studied etiological factor of varicose veins. *J Vasc Res* 48:185–194
16. Lim CS, Kiriakidis S, Paleolog EM, Davies AH (2012) Increased activation of the hypoxia-inducible factor pathway in varicose veins. *J Vasc Surg* 55:1427–1439
17. Gandhi RH, Irizarry E, Nackman GB, Halpern VJ, Mulcare RJ, Tilson MD (1993) Analysis of the connective tissue matrix and proteolytic activity of primary varicose veins. *J Vasc Surg* 18:814–820
18. Lim CS, Shalhoub J, Gohel MS, Shepherd AC, Davies AH (2010) Matrix metalloproteinases in vascular disease – a potential therapeutic target? *Curr Vasc Pharmacol* 8:75–85
19. Jacob MP, Cazaubon M, Scemama A, Prié D, Blanchet F, Guillin MC, Michel JB (2002) Plasma matrix metalloproteinase-9 as a marker of blood stasis in varicose veins. *Circulation* 106:535–538
20. Tanaka H, Zaima N, Sasaki T, Yamamoto N, Sano M, Konno H, Setou M, Unno N (2012) Loss of lymphatic vessels and regional lipid accumulation is associated with great saphenous vein incompetence. *J Vasc Surg* 55:1440–1448
21. Anwar MA, Shalhoub J, Vorkas PA, Lim CS, Want EJ, Nicholson JK, Holmes E, Davies AH (2012) In-vitro identification of distinctive metabolic signatures of intact varicose vein tissue via magic angle spinning nuclear magnetic resonance spectroscopy. *Eur J Vasc Endovasc Surg* 44:442–450
22. Hamdan A (2012) Management of varicose veins and venous insufficiency. *JAMA* 308:2612–2621
23. Rasmussen LH, Lawaetz M, Bjoern L, Vennits B, Blemings A, Eklof B (2011) Randomized clinical trial comparing endovenous laser ablation, radiofrequency ablation, foam sclerotherapy and surgical stripping for great saphenous varicose veins. *Br J Surg* 98:1079–1087
24. Tsang FJ, Davis M, Davies AM, Davies AH (2005) Incomplete saphenopopliteal ligation after short saphenous vein surgery: a summation analysis. *Phlebology* 20:106–109
25. Smith PD (2000) Micronized purified flavonoid fraction and the treatment of chronic venous insufficiency: microcirculatory mechanisms. *Microcirculation* 7:35–40
26. Gohel MS, Davies AH (2010) Pharmacological treatment in patients with C4, C5 and C6 venous disease. *Phlebology* 25:35–41
27. Pittler MH, Ernst E (2012) Horse chestnut seed extract for chronic venous insufficiency. *Cochrane Database Syst Rev* (11):CD003230
28. Canali R, Comitato R, Schonlau F, Virgili F (2009) The anti-inflammatory pharmacology of Pycnogenol ((R)) in humans involves COX-2 and 5-LOX mRNA expression in leukocytes. *Int Immunopharmacol* 9:1145–1149

---

## **Part XII**

### **Blood**



---

# Overview

Deena Iskander and Barbara J. Bain

---

## Anatomy and Physiology of Blood

Blood is made up of cells suspended in plasma. The plasma is composed of electrolytes, proteins, glucose, and lipids dissolved or suspended in water. The cellular compartment comprises red blood cells (erythrocytes, RBCs), platelets (thrombocytes), and white blood cells (leukocytes), which are all produced in the bone marrow (Fig. 1).

Blood is the major transport and delivery system in the body. It transports the end product of internal respiration, carbon dioxide (CO<sub>2</sub>), via the vena cavae and the right side of the heart (see chapter “Overview” under part “Heart”) to the lungs for expiration (see chapter “Overview” under part “Lung”). It delivers oxygenated blood from the lungs to the tissues, via the left side of the heart and the arteries (see chapter “Overview” under part “Blood vessels”). Blood also transports nutrients from the gut to the tissues (see chapter “Overview” under part “Gastrointestinal tract”). The waste products of tissue metabolism are transported via the blood to the site of detoxification, generally the liver (see chapter “Overview”

under part “Liver”), or excretion, generally the kidney (see chapter “Overview” under part “Kidney”). These processes are essential for the metabolic processes that sustain life.

Due to the function of blood as the major transport system of the body, changes in blood constituents influence all organs and tissues. In turn, many diseases can be diagnosed from biomarkers in the blood.

In this chapter, we shall describe the constituents and metabolic activities of blood and highlight diseases resulting from aberrations in these pathways.

---

## Blood-Specific Metabolic/Molecular Pathways and Processes

The constituents of blood are required for its own homeostasis and that of other bodily systems and have many functions. The salient blood-specific metabolic processes are outlined below.

Many diseases are caused by or involve deregulated plasma proteins that are involved in a plethora of metabolic pathways. Some of these diseases are mentioned below.

## Oxygen Transport

Oxygen (O<sub>2</sub>) transport depends upon RBCs and hemoglobin, which are specially adapted for gas transport. The affinity of hemoglobin for oxygen at different partial pressures is represented by a

---

D. Iskander (✉)  
Department of Haematology,  
Imperial College London,  
Hammersmith Campus, London W12 0NN, UK  
e-mail: [d.iskander@imperial.ac.uk](mailto:d.iskander@imperial.ac.uk)

B.J. Bain  
Department of Haematology, Imperial College London,  
St Mary's Hospital Campus, London W2 1NY, UK  
e-mail: [b.bain@imperial.ac.uk](mailto:b.bain@imperial.ac.uk)

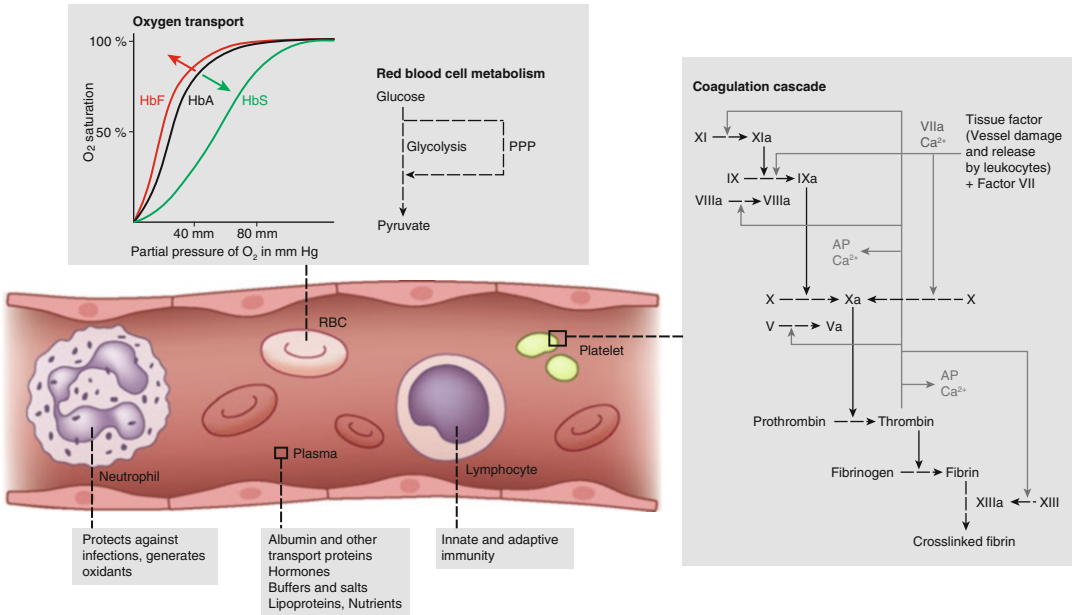

**Fig. 1** Important components of the blood and their physiological function. Erythrocytes (red blood cells, *RBCs*) are the major cellular component of the blood. *RBCs* transport oxygen to the tissues via hemoglobin (*Hb*). Oxygen binding is mainly regulated by partial pressure of  $O_2$  in the surrounding tissues. The major metabolic pathways in *RBCs* are glycolysis and pentose phosphate pathway (*PPP*). Platelets are small anucleate cell fragments in the blood that play a major role in blood clotting. Blood

clotting is regulated by a complex, sequential, cascade-like activation of proteases resulting in cross-linked fibrin to seal an injury. Lymphocytes, components of the immune system, are also transported by the blood. Similarly, neutrophils aid in host defense. Additionally, the blood plasma transports various proteins, hormones, ions, and buffers. *AP* activated platelets, *HbF* fetal hemoglobin, *HbA* adult hemoglobin, *HbS* sickle-cell hemoglobin

sigmoid-shaped oxygen dissociation curve (Fig. 1). Oxygen binding depends on the structure of hemoglobin in terms of its subunits and on external factors such as acidity, temperature, and partial pressure of oxygen. Hemoglobin is a tetrameric protein consisting of two  $\alpha$  chains combined with combined with, in adult Hb, 2 alpha chains (HbA) or two delta chains (HbA2) and in fetal Hb, 2  $\gamma$  chains (HbF) [1]. In sickle-cell anemia (see chapter “Sickle cell disease”), a variant called HbS replaces HbA. This has reduced oxygen affinity compared with HbA, partially explaining the lower hemoglobin concentration observed in patients [1].

Oxygen is transported by binding to the  $Fe^{2+}$  present in the heme component of hemoglobin. If the iron is oxidized to  $Fe^{3+}$ , oxygen does not bind. Binding of oxygen to one heme molecule increases the oxygen affinity of other hemes by a mechanism called cooperativity.  $CO_2$  and protons

( $H^+$ ) decrease oxygen affinity (known as the “Bohr effect” [2]) as does 2,3-diphosphoglycerate (2,3-DPG), a side product of glycolysis, so that  $O_2$  is more easily released in metabolically active tissues.

### Carbon Dioxide ( $CO_2$ ) Transport

This occurs by three mechanisms:  $CO_2$  dissolved in plasma (5–10 %),  $CO_2$  bound to proteins such as hemoglobin as a carbamate (5–10 %), and, principally,  $CO_2$  combined with water to form carbonic acid ( $H_2CO_3$ , 70–80 %). The latter reaction is catalyzed by carbonic anhydrase in the *RBC*. In an equilibrium reaction, carbonic acid then dissociates to form bicarbonate ions ( $HCO_3^-$ ) and  $H^+$ . This not only allows transport of  $CO_2$  but also favors the release of  $O_2$  from hemoglobin at the site of high aerobic demand [3].

## Buffering and Homeostasis

Buffers in the blood maintain its pH within a narrow range of 7.35–7.45. Hemoglobin is the most important buffer for carbonic acid because of its high concentration and large number of histidine residues that bind hydrogen ions ( $H^+$ ). Deoxyhemoglobin binds hydrogen ions even more easily than oxyhemoglobin. This synchronizes buffering action with the generation of additional  $H^+$ , increasing the amount of  $CO_2$  that can be carried back to the lungs. General acidosis is buffered by other buffering systems such as bicarbonate, which binds metabolic acids, and phosphate, which serves a minor role in buffering due to the low concentration of phosphate ions in the blood [3]. Plasma proteins such as albumin may also contribute to buffering, but their main role is the regulation of blood volume by maintaining oncotic pressure. Disease states leading to hypoalbuminemia, for example, liver disease and nephrotic syndrome, therefore result in edema [2].

## Iron Transport

This occurs by iron binding to the plasma protein transferrin, although  $<0.5\%$  total body iron is present in the plasma. On average, two thirds of total body iron is incorporated into hemoglobin, and the remainder is mainly stored in the liver, bound to ferritin, or in body macrophages, as hemosiderin. Iron-deficiency anemia is preceded by a depletion of body iron stores and a fall in serum ferritin concentration [4].

## Coagulation Pathway and Anticoagulant Properties

Hemostasis depends upon platelets and a series of coagulation factors that cooperate in a series of complex interactions. The coagulation factors are inactive zymogen proteins, mainly serine proteases. On activation by proteolytic cleavage, they can activate one or more other components, ultimately leading to clot formation

and hemostasis (Fig. 1). Physiological coagulation occurs following injury and precedes wound healing, whereas pathological clotting occurs in intravascular sites, for example, in coronary artery occlusion and thrombotic stroke. Hemophilia – a failure of hemostasis – is caused by mutations in one of the genes encoding coagulation factors, for example, hemophilia A is due to a mutation in the gene encoding factor VIII.

The plasma contains naturally occurring anticoagulants, such as protein C, protein S, and antithrombin, which regulate the activity of the coagulation cascade. Deficiency of these factors can lead to a thrombotic tendency. The plasma also contains proteins that lead to fibrinolysis, for example, tissue plasminogen activator, and proteins that regulate fibrinolysis, for example, plasminogen activator inhibitor and  $\alpha 2$ -antiplasmin. The former reestablish vascular patency after thrombosis, while the latter prevent excess breakdown of thrombi at the site of injury [5].

## Leukocytes

Leukocytes, namely, neutrophils, eosinophils, basophils, lymphocytes, and monocytes, are an important component of blood as they form part of the body's defense mechanism against infection (see chapter “[Overview](#)” under part “Immune system”).

## Hormonal Transport for Regulation of Whole Body Metabolism

As the body's primary transport system, the blood carries endocrine signals from the secretory glands to the target. These chemical messengers, or hormones, are either dissolved in the plasma (in the case of hydrophilic hormones such as epinephrine) or bound to carriers such as albumin (in the case of lipophilic hormones such as glucocorticoids). As hormones are major regulators of metabolism and homeostasis, disturbances in the blood can significantly impair this communication system [2].

## Lipoprotein Metabolism

Lipoproteins are micellar-like aggregates used to transport lipophilic substances within the blood stream, delivering various lipids to target tissues and recycling them to the liver (see chapter “Hyperlipidemia”).

---

## Inside-In: Metabolites of the Blood Affecting the Blood Itself

The biconcave shape of the RBC optimizes its flexibility and oxygen exchange across the cell surface. Mature RBCs lack nuclei, mitochondria, and ribosomal machinery, maximizing the storage capacity for hemoglobin. At the same time, the lack of these organelles limits the RBC’s metabolic capacity. Yet, they undertake two major metabolic pathways, anaerobic glycolysis and the pentose phosphate pathway (metabolizing 90 and 10 % of the RBC’s glucose, respectively). While anaerobic glycolysis provides the energy required for the RBC membrane ion pumps, the pentose phosphate pathway provides the reduction potential to protect against oxidant damage. Both contribute to maintaining Fe<sup>2+</sup> in its reduced state.

### The Anaerobic Glycolytic (Embden-Meyerhof) Pathway

This pathway metabolizes glucose to generate energy and has three important products: (i) adenosine-5'-triphosphate (ATP) mainly powers ion transport across the RBC membrane to maintain normal homeostasis despite exposure to osmotic stress, for example, in the renal circulation. In particular, the red cell membrane sodium pump maintains the osmotic potential within red cells, preventing their lysis. (ii) Nicotinamide adenine dinucleotide (NADH) is a cofactor in the methemoglobin reductase reaction. This regulates the conversion of methemoglobin (containing Fe<sup>3+</sup>) back to hemoglobin (containing Fe<sup>2+</sup>), as only the latter can bind oxygen (see above). (iii) 2,3-DPG is an allosteric effector of

hemoglobin, binding to deoxyhemoglobin, thus favoring oxygen release.

Inherited deficiency of glycolytic enzymes (most commonly pyruvate kinase) can lead to chronic hemolytic anemia because the resulting decrease in ATP levels impairs the aforementioned ion pumps leading to cell swelling and lysis.

### The Pentose Phosphate Shunt (or Pentose Phosphate Pathway)

As oxygen concentration in the RBC is very high, heme iron is in danger of oxidation, deactivating its function and producing reactive oxygen species such as superoxide O<sub>2</sub><sup>-</sup>. The red cell is also subject to exogenous oxidant stress, for example, from drugs and dietary constituents. The pentose phosphate pathway protects the RBC against oxidant damage in order both to maintain the iron in hemoglobin in a reduced, ferrous state (Fe<sup>2+</sup>) and also to limit oxidant attack on RBC membrane proteins and lipids. The pentose phosphate shunt generates NADPH, which, in turn, maintains the supply of reduced glutathione in the cells that is used to mop up free radicals that cause oxidative damage.

Inherited deficiency of enzymes of the pentose phosphate shunt renders the red blood cells susceptible to oxidant stress. The most common of these worldwide is X-linked glucose-6-phosphate dehydrogenase (G6PD) deficiency, which is manifest as acute hemolysis following oxidant stress [4].

---

## Inside-Out: Metabolites of the Blood Affecting Other Tissues

At the end of their natural lifespan of about 120 days, red blood cells are mainly removed by splenic macrophages. In pathological states, intravascular hemolysis can occur. This releases hemoglobin that binds to plasma haptoglobin. This complex is metabolized in the liver, which degrades hemoglobin to iron and protoporphyrin (Fig. 2). The latter is converted to bilirubin and

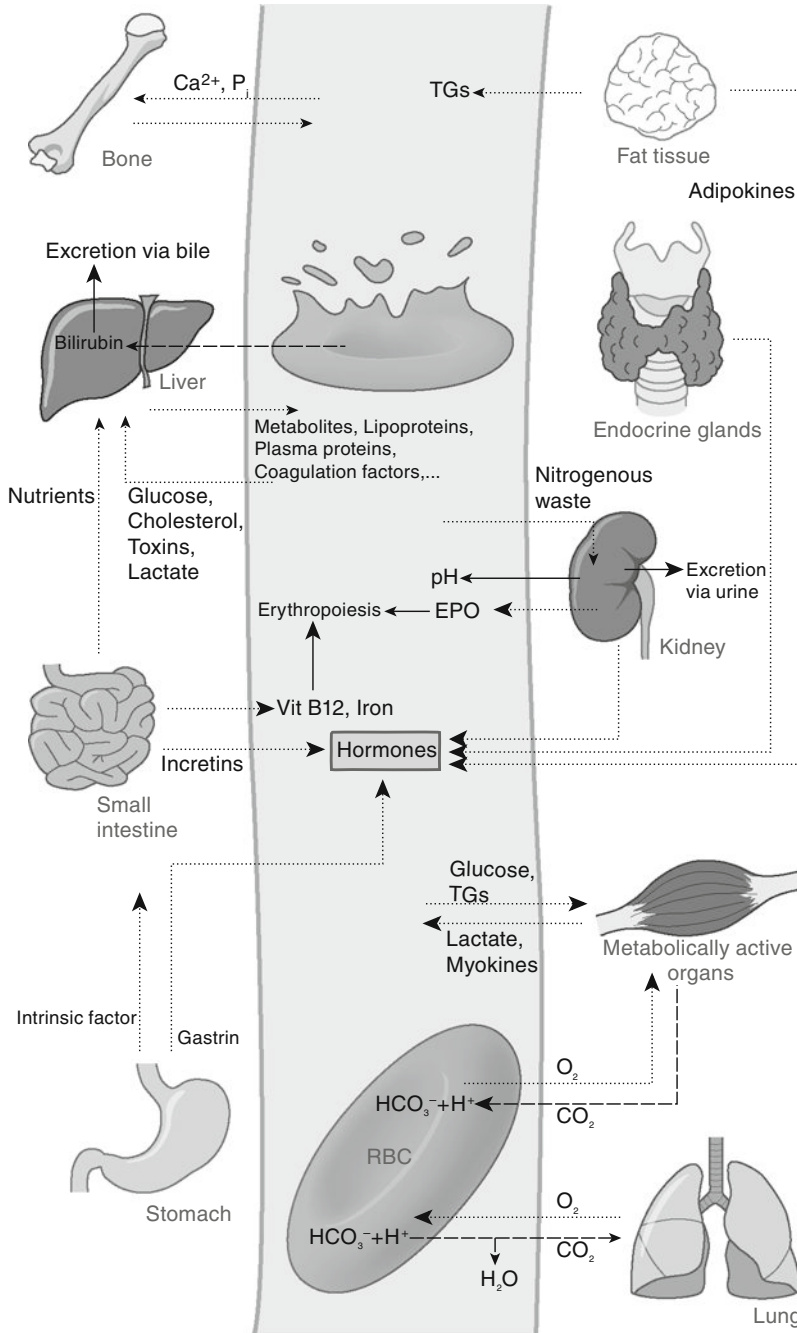

**Fig. 2** Interactions of blood with other organs. As the major transport system in the body, the blood interacts with virtually all organs and tissues. Nutrients absorbed from the small intestine are transported to the liver and further to the whole body (e.g., to skeletal muscle). Recycling and redistribution of nutrients and their products (e.g., from skeletal muscle and adipocytes) also occur via the blood. The liver contributes a multitude of metabolic products to the blood stream to be transported to the target tissues. This includes glucose from gluconeogenesis or glycogen stores and triglycerides (also called triacylglycerols, *TGs*) and cholesterol being transported in lipoproteins, amino acids, and

ketone bodies during prolonged fasting. Ions transported in the blood are critical for bone stability (mainly calcium) and erythropoiesis (mainly iron). Hormones, such as erythropoietin (*EPO*) from the kidney, are secreted into the blood by a large variety of endocrine organs. “Cleaning” of the blood occurs in the kidney, where unwanted contents such as nitrogenous waste can be excreted and pH changes can be regulated. Red blood cells (*RBCs*) transport  $O_2$  and aid in  $CO_2$  transport from and to the lungs, respectively. Hemoglobin degradation products released from “dying” erythrocytes are generally removed via the liver.  $P_i$  inorganic phosphate ( $PO_4^{3-}$ ), *Vit B12* vitamin B12

then bilirubin glucuronide, which is excreted in the bile. Iron is recycled. Within the intestine, bacteria convert bilirubin to urobilinogen, which either is reabsorbed and excreted in the urine or passes further down the intestinal tract forming stercobilinogen [2]. Both products contribute to the color of the excretions.

If the rate of hemolysis exceeds the plasma supply of haptoglobin, free hemoglobin is excreted in the urine with some being reabsorbed and the iron incorporated into ferritin and then hemosiderin in the renal tubules. Initial hemoglobinuria is thus followed by hemosiderinuria, as renal tubule cells (containing the hemosiderin) are lost in the urine. Acute intravascular hemolysis can cause renal failure (see chapter “[Chronic kidney disease](#)”). Cell-free plasma hemoglobin also acts as a nitric oxide scavenger, which can lead to adverse effects on blood vessels (e.g., vasoconstriction, see chapter “[Overview](#)” under part “[Blood vessels](#)”). The accumulation of bilirubin in the circulation also leads to a yellow discoloration of the skin, that is, jaundice. Chronic hemolysis leads to the formation of pigment gallstones [2].

---

### Outside-In: Metabolites of Other Tissues Affecting the Blood

Impaired function of many organs, including the lungs and kidneys, involved in the regulation of blood oxygen levels, pH, and/or temperature can affect blood metabolism by shifting the oxygen dissociation curve (Fig. 1).

Normal hematopoiesis requires a supply of nutrients, including iron, vitamin B<sub>12</sub>, and folic acid. Their availability is dependent on normal intestinal absorption. Vitamin B<sub>12</sub> absorption additionally requires that the stomach secretes intrinsic factor, which combines with B<sub>12</sub>, permitting its absorption by the small intestine (see chapter “[Overview](#)” under part “[Gastrointestinal tract](#)” and Fig. 2). Thus, celiac disease and autoimmune gastric atrophy can lead indirectly to anemia. Erythropoiesis requires normal levels of growth hormone and adrenal and thyroid hormones, so that hypopituitarism, adrenal

insufficiency, and hypothyroidism all lead to anemia. Erythropoiesis likewise requires normal renal function, including production of erythropoietin (see chapter “[Overview](#)” under part “[Kidney](#)”). In renal failure (see chapter “[Chronic kidney disease](#)”), there is reduced synthesis of erythropoietin and thus anemia. In addition, nitrogenous waste products, including urea, accumulate in the blood, suppressing erythropoiesis and leading to platelet dysfunction and hemorrhage. Acid/base disturbance can also impact upon the oxygen dissociation curve.

In liver disease, abnormal metabolism can lead to specific forms of hemolytic anemia.

Zieve’s syndrome is characterized by acute hemolysis, irregularly contracted red cells, and hyperlipidemia associated with alcoholic fatty liver. Spur cell hemolytic anemia shows marked acanthocytosis (RBCs with a spiked, thorny cell membrane) occurring in liver failure of any etiology. Acute oxidant-induced Heinz body hemolytic anemia can occur in advanced Wilson’s disease as a result of the oxidant effect of copper released from damaged or dying liver cells. Liver disease also leads to impaired synthesis of coagulation factors and thus hemorrhage [6].

Acute infection can cause anemia, neutrophilia, platelet consumption, and activation of coagulation. Infection generates oxidant substances and can lead to hemolysis in G6PD-deficient subjects (see above). Chronic infections and inflammatory states lead to generation of cytokines, causing anemia of chronic disease, in which iron is not mobilized from macrophages.

---

### Final Remarks

The blood is the major transport system in the body, delivering oxygen and nutrients to the tissues for metabolic processes and removing the waste products of metabolic reactions. Measurement of the levels of blood constituents can therefore assist the diagnosis and monitoring of many diseases. Diseases of many organs and tissues can adversely influence hematopoiesis and impair the homeostatic mechanisms of the blood.

## References

1. Bain BJ (2014) *Blood cells a practical guide*, 5th edn. Wiley-Blackwell, Oxford
2. Haslett C, Chilvers ER, Boon NA, Colledge NR (2002) *Davidson's principles and practice of medicine*, 19th edn. Churchill Livingstone, Edinburgh
3. Brandis K Anaesthesia education website. Available from URL: <http://www.anaesthesiaMCQ.com>
4. Bain BJ, Gupta R (2003) *A-Z of haematology*, 1st edn. Blackwell Publishing Ltd., Oxford
5. Laffan MA, Manning R (2012) Investigation of haemostasis. In: Bain BJ, Bates I, Laffan MA, Lewis SM (eds) *Dacie and Lewis practical haematology*, 11th edn. Churchill Livingstone, Edinburgh
6. Mamun-al-Mahtab SR (2009) *Liver: a complete book on hepato-pancreato-biliary diseases*, 1st edn. Elsevier India, Guragon



---

# Sickle Cell Disease

Daniel A. Dworkis and Martin H. Steinberg

---

## Introduction to Sickle Cell Disease

A mutation in the  $\beta$ -hemoglobin gene that codes for a variant hemoglobin, sickle hemoglobin (HbS), in which the glutamate at position 6 of the protein is exchanged for valine (*HBB* glu6val), is the genetic basis of sickle cell disease (SCD). SCD is found in about 1 in 300 African Americans at birth, but its incidence can be much higher in parts of Africa, the Middle East, and India, regions where the HbS mutation first arose. When deoxygenated, HbS polymerizes resulting in erythrocyte (RBC) deformation (known as “sickling”) and cellular damage, provoking the clinical and laboratory features characteristic of SCD. These include vasoocclusion, hemolytic anemia, widespread acute and chronic organ damage, and reduced lifespan [1]. Patients with SCD can be homozygous for the HbS mutation, compound heterozygotes for the HbS mutation, and another variant that “interacts” with HbS, compound heterozygotes for HbS and a  $\beta$ -thalassemia mutation. Simple heterozygotes are said to have sickle

cell trait and, with rare exceptions, are well [2]. HbS homozygotes show the most severe symptoms and a great deal of phenotypic heterogeneity, likely as a result of many interacting genes or proteins. Chief among the genetic abnormalities that modulate the phenotype of SCD is  $\alpha$ -thalassemia, which reduces RBC density and HbS concentration, reducing hemolysis, and mutations in various regulators of fetal hemoglobin (HbF) gene expression. HbF can thwart the polymerization of HbS [3, 4]. Many other genes are likely to modulate the phenotype of SCD.

---

## Pathophysiology of Sickle Cell Disease and Metabolic Alterations

HbS and its polymer damage the RBC membrane (Fig. 1), resulting in cation channel activation (see below) leading to cellular dehydration and rigidity; abnormal adhesive interactions among RBCs, leukocytes, and endothelial cells mediated by a variety of adhesion molecules and their ligands; and an inflammatory response secondary to endothelial activation and damage [5, 6]. Activation of the Gardos channel (a  $\text{Ca}^{2+}$ -activated  $\text{K}^+$  channel) and  $\text{K}^+:\text{Cl}^-$  cotransport channel and perhaps other ion transport channels like PIEZO1 (a mechanosensitive ion channel), by deoxygenation, acidification, cell swelling,  $\text{Ca}^{2+}$  influx, and cell sickling lead to dense, dehydrated sickle RBCs in which the polymerization tendency of HbS is increased. Perturbed endothelial cells display adhesion

---

D.A. Dworkis  
Boston University School of Medicine,  
15 Bigelow St, Apt#3, Cambridge, MA 02139, USA  
e-mail: [ddworkis@bu.edu](mailto:ddworkis@bu.edu)

M.H. Steinberg (✉)  
Department of Medicine,  
Boston University School of Medicine,  
Center of Excellence in Sickle Cell Disease,  
72 East Concord St., Room E248, Boston,  
MA 02118, USA  
e-mail: [mhsteinb@bu.edu](mailto:mhsteinb@bu.edu)



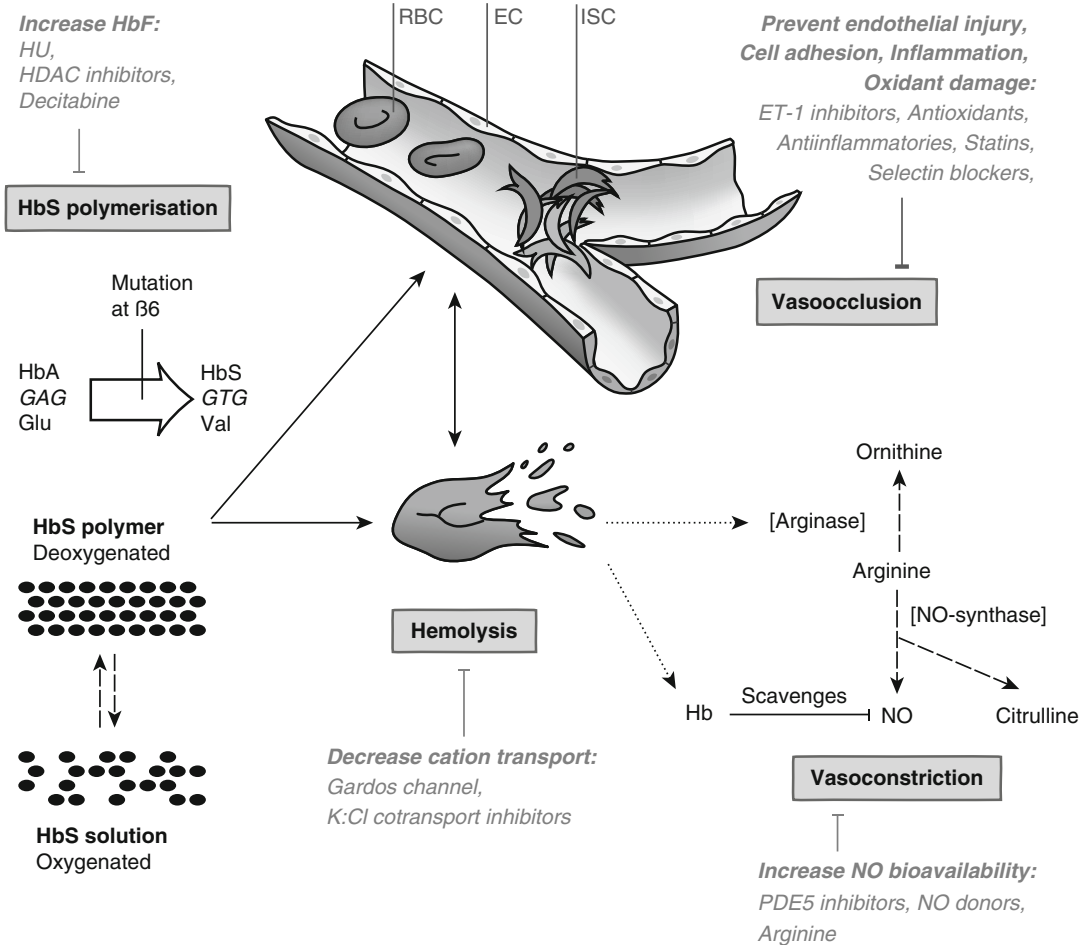

**Fig. 1** Pathophysiology of sickle cell disease and pathophysiological-based treatment approaches. DeoxyHbS (sickle cell hemoglobin) polymerizes deforming and injuring the sickle RBC (red blood cell), leading to vasoocclusion and hemolytic anemia. Intravascular hemolysis of sickle cells releases heme into the blood that scavenges nitric oxide (NO), and the liberated arginase destroys arginine, the substrate of the NO synthases. Each facet of the pathophysiology of disease could be targeted to interfere with its adverse effects. Agents that induce HbF (fetal hemoglobin) expression, such as hydroxyurea (HU, upper

left), can reduce the polymerization tendency of HbS. Cell density (and thus hemolysis) could be reduced by inhibiting cation transport channels (bottom center), adhesive interactions with the endothelium could be interrupted by blocking receptor-ligand docking (upper right), and finally, availability and effects of NO could be increased (bottom right). Current standard treatment options comprise only HU. HDAC histone deacetylase, HbA adult hemoglobin, Glu glutamate, Val valine, EC endothelial cell, ISC irreversibly sickled cell, Hb Hemoglobin, ET-1 endothelin-1, PDE phosphodiesterase

molecules like integrins, selectins, and VCAM, produce cytokines and inflammatory mediators, and develop a procoagulant phenotype, thereby attracting adhesive erythrocytes, leukocytes, and platelets. Together, intrinsic features in the sickle RBC, like polymer content, and extrinsic factors from their environment, like endothelial injury, may result in decreased blood flow and vasooc-

clusion. Hemolysis, or premature destruction of RBCs, is a result of membrane damage to the sickle erythrocyte due to HbS polymer, oxidant radical generation, and the exposure of epitopes that facilitate the interaction of sickle cells with endothelium and macrophages. Intravascular hemolysis, which makes up 33 % percent of all hemolysis, is accompanied by the liberation

of free hemoglobin that scavenges nitric oxide (NO) promoting vasoconstriction and inflammation. Certain complications of disease are strongly correlated with the intensity of intravascular hemolysis, NO depletion, and proliferative vasculopathy [7, 8]. Complications associated with intravascular hemolysis include pulmonary hypertension (due to vasoconstriction secondary to loss of NO), which affects up to 10 % of adults and is a leading cause of SCD mortality; skin ulceration, usually around the ankles; priapism, a prolonged undesirable painful erection (e.g., due to venous outflow occlusion in the penis because of reduced NO bioavailability), seen in 40 % of men; and renal failure (due to kidney overload with degradation products).

Vasooclusion and hemolysis provoke the majority of clinical complications of SCD [9]. “Sickle crises,” episodes of excruciating pain that is likely to be initiated by sickle vasooclusion and lasts hours to days, occur in most patients with varying frequencies. Exactly why these attacks occur is not known, but they are presumed to originate from sickle vasooclusion with subsequent inflammation. The acute chest syndrome, a vasoocclusive episode of the lung of sickle cell disease patients often precipitated by necrotic bone marrow emboli and infection among other causes, is characterized by fever, chest pain, wheezing, cough, hypoxia, lung infiltrate, and a mortality rate of about 5 %. Osteonecrosis of the hip and shoulder joints affects about half of all patients and can progress to loss of joint functionality. Osteonecrosis and bone marrow emboli are likely caused by microvascular occlusion. Another major complication of sickle cell anemia is stroke, caused by stenosis and vessel occlusion in children; hemorrhagic stroke is more common in adults.

---

### **Introduction to Treatment, Influence on Metabolism, and Consequences for Patients**

Most treatments for SCD, such as fluid replacement and opioid analgesics for acute and sometimes chronic pain, only relieve symptoms without

altering the basic pathophysiology of the disease [10]. The sole available pathophysiological-based treatment is hydroxyurea (HU, also known as hydroxycarbamide), which increases HbF concentration [11–23]. Mechanistically, HU is cytotoxic, causing erythroid regeneration and selection of erythroid progenitors that synthesize HbF; it may also lead to augmented  $\gamma$ -globin gene expression via a NO-mediated increase in cGMP [24], thus increasing HbF synthesis. Since HbF interferes with HbS polymerization, inducing sufficiently high levels in most or all sickle RBCs should “cure” SCD; unfortunately, this is not yet possible clinically [25]. HU is effective in reducing many of the complications of SCD and prolongs life in SCD patients. It should be given to nearly all patients homozygous for the HbS gene starting very early in life. Although its adverse effects in adults are minor, the long-term consequences of decades of use in children started on therapy in the first years of life have yet to be assessed.

An additional therapeutic approach is chronic blood transfusion, which is tedious and includes risks such as iron overload, alloimmunization (an immune reaction against the “foreign” blood), and viral infection [26, 27]. Finally, hematopoietic stem-cell transplantation in children (and to some extent in adults) can cure SCD [28]. Its major difficulties lie in the lack of suitable bone marrow donors (<10 %) and a 5–10 % mortality [28, 29].

---

### **Perspectives**

Although HU is generally successful, its effects are inconsistent. Thus, new agents that induce higher levels of HbF more consistently by remodeling chromosomal structure, like short-chain fatty acids and their derivatives, or affect hypomethylation of the HbF gene promoters, like decitabine, are currently undergoing clinical trials [30].

Drugs that target other aspects of sickle cell pathophysiology like RBC dehydration, NO dysregulation, and inflammation might provide successful adjunct therapy in the future.

Reducing the leak of potassium and water from the RBC (by using Gardos or K:Cl channel blockers, Fig. 1) may prevent dehydration and retard polymer formation by reducing HcblbS concentration. However, as this approach is accompanied by a reduction in hemolysis, it must be coupled with a concomitant increase in HbF to prevent viscosity-associated complications. Agents that improve the bioavailability of NO, like arginine, nitrite, and sildenafil (a phosphodiesterase-5 inhibitor, increasing the available cGMP and thus the downstream effects of NO), may also be useful [31]. Drugs that have anti-inflammatory properties may reduce the endothelial damage and SCD vasculopathy (Fig. 1) [32].

Ultimately, gene therapy is a chief hope for treating SCD. Recent studies using lentiviral vectors for transducing erythroid progenitors with a “therapeutic” gene have brought this objective closer to realization, but additional study is required [33, 34].

When last carefully studied in the 1990s, the median survival of SCD patients in the United States was between 40 and 60 years, depending on the genotype of disease. Nowadays, when well managed, nearly all children survive to age 20 years. The impact of new treatment cannot be assessed, but earlier and more widespread use of HU and better adherence to this treatment, along with continued improvement in supportive care, might be expected to further improve the outlook.

## References

- Steinberg MH, Forget BG, Higgs DR, Weatherall DJ (2009) Disorders of hemoglobin: genetics, pathophysiology, clinical management, 2nd edn. Cambridge University Press, Cambridge
- Goldsmith JC, Bonham VL, Joiner CH, Kato GJ, Noonan AS, Steinberg MH (2012) Framing the research agenda for sickle cell trait: building on the current understanding of clinical events and their potential implications. *Am J Hematol* 87:340–346
- Steinberg MH, Sebastiani P (2012) Genetic modifiers of sickle cell disease. *Am J Hematol* 87:824–826
- Poillon WN, Kim BC, Rodgers GP, Noguchi CT, Schechter AN (1993) Sparing effect of hemoglobin F and hemoglobin A 2 on the polymerization of hemoglobin S at physiologic ligand saturations. *Proc Natl Acad Sci U S A* 90:5039–5043
- Joiner CH, Gallagher PG (2009) The erythrocyte membrane. In: Steinberg MH, Forget BG, Higgs DR, Nagel RL (eds) Disorders of hemoglobin: genetics, pathophysiology, and clinical management. Cambridge University Press, Cambridge
- Conran N, Costa FF (2009) Hemoglobin disorders and endothelial cell interactions. *Clin Biochem* 42:1824–1838
- Reiter CD, Wang X, Tanus-Santos JE, Tanus-Santos JE, Hogg N, Cannon RO 3rd, Schechter AN, Gladwin MT (2002) Cell-free hemoglobin limits nitric oxide bioavailability in sickle-cell disease. *Nat Med* 8:1383–1389
- Kato GJ, Gladwin MT, Steinberg MH (2007) Deconstructing sickle cell disease: reappraisal of the role of hemolysis in the development of clinical subphenotypes. *Blood Rev* 21:37–47
- Steinberg MH (2011) In the clinic. Sickle cell disease. *Ann Intern Med* 155:ITC31–15
- Bartolucci P, Galacteros F (2012) Clinical management of adult sickle-cell disease. *Curr Opin Hematol* 19:149–155
- Platt OS, Orkin SH, Dover G, Beardsley GP, Miller B, Nathan DG (1984) Hydroxyurea enhances fetal hemoglobin production in sickle cell anemia. *J Clin Invest* 74:652–656
- Dover GJ, Humphries RK, Moore JG, Ley TJ, Young NS, Charache S, Nienhuis AW (1986) Hydroxyurea induction of hemoglobin F production in sickle cell disease: relationship between cytotoxicity and F cell production. *Blood* 67:735–738
- Steinberg MH, Lu ZH, Barton FB, Terrin ML, Charache S, Dover GJ (1997) Fetal hemoglobin in sickle cell anemia: determinants of response to hydroxyurea. Multicenter Study of Hydroxyurea. *Blood* 89:1078–1088
- Bridges KR, Barabino GD, Brugnara C, Cho MR, Christoph GW, Dover G, Ewenstein BM, Golan DE, Guttmann CR, Hofrichter J, Mulkern RV, Zhang B, Eaton WA (1996) A multiparameter analysis of sickle erythrocytes in patients undergoing hydroxyurea therapy. *Blood* 88:4701–4710
- Cokic VP, Andric SA, Stojilkovic SS, Noguchi CT, Schechter AN (2008) Hydroxyurea nitrosylates and activates soluble guanylyl cyclase in human erythroid cells. *Blood* 111:1117–1123
- Cokic VP, Beleslin-Cokic BB, Tomic M, Stojilkovic SS, Noguchi CT, Schechter AN (2006) Hydroxyurea induces the eNOS-cGMP pathway in endothelial cells. *Blood* 108:184–191
- Lanaro C, Franco-Penteado CF, Albuquerque DM, Saad ST, Conran N, Costa FF (2009) Altered levels of cytokines and inflammatory mediators in plasma and leukocytes of sickle cell anemia patients and effects of hydroxyurea therapy. *J Leukoc Biol* 85:235–242
- Charache S, Terrin ML, Moore RD, Dover GJ, Barton FB, Eckert SV, McMahon RP, Bonds DR (1995)

- Effect of hydroxyurea on the frequency of painful crises in sickle cell anemia. *N Engl J Med* 332: 1317–1322
19. Steinberg MH, Barton F, Castro O et al (2003) Effect of hydroxyurea on mortality and morbidity in adult sickle cell anemia: risks and benefits up to 9 years of treatment. *JAMA* 289:1645–1651
  20. Steinberg MH, McCarthy WF, Castro O, Pegelow CH, Ballas SK, Kutlar A, Orringer E, Bellevue R, Olivieri N, Eckman J, Varma M, Ramirez G, Adler B, Smith W, Carlos T, Ataga K, DeCastro L, Bigelow C, Sauntharajah Y, Telfer M, Vichinsky E, Claster S, Shurin S, Bridges K, Waclawiw M, Bonds D, Terrin M (2010) The safety and effectiveness of hydroxyurea in sickle cell anemia: a 17.5 year follow-up. *Am J Hematol* 85:403–408
  21. Wang WC, Ware RE, Miller ST, Iyer RV, Casella JF, Minniti CP, Rana S, Thornburg CD, Rogers ZR, Kalpatthi RV, Barredo JC, Brown RC, Sarnaik SA, Howard TH, Wynn LW, Kutlar A, Armstrong FD, Files BA, Goldsmith JC, Waclawiw MA, Huang X, Thompson BW (2011) Hydroxycarbamide in very young children with sickle-cell anaemia: a multicentre, randomised, controlled trial (BABY HUG). *Lancet* 377:1663–1672
  22. Voskaridou E, Christoulas D, Bilalis A, Plata E, Varvagiannis K, Stamatopoulos G, Sinopoulou K, Balassopoulou A, Loukopoulos D, Terpos E (2009) The effect of prolonged administration of hydroxyurea on morbidity and mortality in adult patients with sickle-cell syndromes: results of a 17-year, single center trial (LaSHS). *Blood* 115:2354–2363
  23. Thornburg CD, Files BA, Luo Z, Miller ST, Kalpatthi R, Iyer R, Seaman P, Lebensburger J, Alvarez O, Thompson B, Ware RE, Wang WC (2012) Impact of hydroxyurea on clinical events in the BABY HUG trial. *Blood* 120:4304–4310
  24. Almeida CB, Scheiermann C, Jang JE, Prophete C, Costa FF, Conran N, Frenette PS (2012) Hydroxyurea and a cGMP-amplifying agent have immediate benefits on acute vaso-occlusive events in sickle cell disease mice. *Blood* 120:2879–2888
  25. Sankaran VG (2011) Targeted therapeutic strategies for fetal hemoglobin induction. *Hematology Am Soc Hematol Educ Program* 2011:459–465
  26. Wayne AS, Keyv SV, Nathan DG (1993) Transfusion management of sickle cell disease. *Blood* 81:1109–1123
  27. Yazdanbakhsh K, Ware RE, Noizat-Pirenne F (2012) Red blood cell alloimmunization in sickle cell disease: pathophysiology, risk factors, and transfusion management. *Blood* 120:528–537
  28. Hsieh MM, Kang EM, Fitzhugh CD, Link MB, Bolan CD, Kurlander R, Childs RW, Rodgers GP, Powell JD, Tisdale JF (2009) Allogeneic hematopoietic stem-cell transplantation for sickle cell disease. *N Engl J Med* 361:2309–2317
  29. Atkins RC, Walters MC (2003) Haematopoietic cell transplantation in the treatment of sickle cell disease. *Expert Opin Biol Ther* 3:1215–1224
  30. Wilber A, Nienhuis AW, Persons DA (2011) Transcriptional regulation of fetal to adult hemoglobin switching: new therapeutic opportunities. *Blood* 117:3945–3953
  31. Canalli AA, Franco-Penteado CF, Saad ST, Conran N, Costa FF (2008) Increased adhesive properties of neutrophils in sickle cell disease may be reversed by pharmacological nitric oxide donation. *Haematologica* 93:605–609
  32. Kotiah SD, Ballas SK (2009) Investigational drugs in sickle cell anemia. *Expert Opin Investig Drugs* 18:1817–1828
  33. Pawliuk R, Westerman KA, Fabry ME, Payen E, Tighe R, Bouhassira EE, Acharya SA, Ellis J, London IM, Eaves CJ, Humphries RK, Beuzard Y, Nagel RL, Leboulch P (2001) Correction of sickle cell disease in transgenic mouse models by gene therapy. *Science* 294:2368–2371
  34. Cavazzana-Calvo M, Payen E, Negre O, Wang G, Hehir K, Fusil F, Down J, Denaro M, Brady T, Westerman K, Cavalleco R, Gillet-Legrand B, Caccavelli L, Sgarra R, Maouche-Chrétien L, Bernaudin F, Girot R, Dorazio R, Mulder GJ, Polack A, Bank A, Soulier J, Larghero J, Kabbara N, Dalle B, Gourmel B, Socie G, Chrétien S, Cartier N, Aubourg P, Fischer A, Cornetta K, Galacteros F, Beuzard Y, Gluckman E, Bushman F, Hacein-Bey-Abina S, Leboulch P (2010) Transfusion independence and HMGA2 activation after gene therapy of human beta-thalassaemia. *Nature* 467:318–322

---

# Hyperlipidemia

Paul Durrington and Handrean Soran

---

## Introduction to Hyperlipidemia

The lipids in the body are mainly represented by cholesterol, triglycerides (TGs, also called triacylglycerides), and phospholipids. Lipids are transported in the blood as lipoproteins, which are mixed micellar-like particles with a central droplet containing their most hydrophobic components, cholesteryl esters and TGs, and an outer layer comprising amphiphilic phospholipid molecules interspersed with free (nonesterified) cholesterol, giving the particle a hydrophilic surface [1, 2]. The protein components of lipoproteins are mainly enzymes, such as lecithin-cholesterol acyltransferase (LCAT), and apolipoproteins. The latter play important roles in lipid and lipoprotein secretion by the liver and gut, transport in the lymph and blood, and uptake by various tissues, as they serve as receptor ligands. Also, they have structural and regulatory roles, modifying the activity of enzymes relevant to lipoprotein metabolism. They are oriented similarly to the lipids, with hydrophobic regions toward the

core and polar regions outside. The lipoproteins are classified into four major classes (see below), which differ in size, density, composition, and function (Fig. 1).

In this chapter, we will give an overview of lipoprotein physiology and metabolism followed by discussion of its major disturbances, the hyperlipidemias.

---

## Physiological Lipoprotein Metabolism

### Chylomicrons

The largest lipoproteins are the chylomicrons produced by the enterocytes of the small intestine carrying nutritional TGs and entering the blood circulation via the lymph. During tissue passage, TGs are hydrolyzed by lipoprotein lipase (LPL) located on capillary endothelium to fatty acids and glycerol, which are then used as respiratory substrates or reconstituted (into TGs) as an energy store. LPL has a binding site for sulfated glycosaminoglycans and another for apoCII. The former site allows it to be anchored to the capillary endothelium. LPL protrudes from that attachment into the current of circulating blood, where it comes into contact with apoCII-rich lipoproteins like chylomicrons and very-low-density lipoprotein (VLDL). LPL requires apoCII as a cofactor, if it is to be active. Its activity is greater for larger chylomicrons than for VLDL. Thus, chylomicrons are converted to TG-depleted

---

P. Durrington (✉)  
Cardiovascular Research Group,  
School of Biomedicine, University of Manchester,  
Manchester M13 9NT, UK  
e-mail: [p.adlib@doctors.org.uk](mailto:p.adlib@doctors.org.uk)

H. Soran  
Department of Medicine, Central Manchester  
University Hospitals NHS Foundation Trust,  
Oxford road,  
Manchester M13 9WL, UK  
e-mail: [handrean.soran@cmft.nhs.uk](mailto:handrean.soran@cmft.nhs.uk)

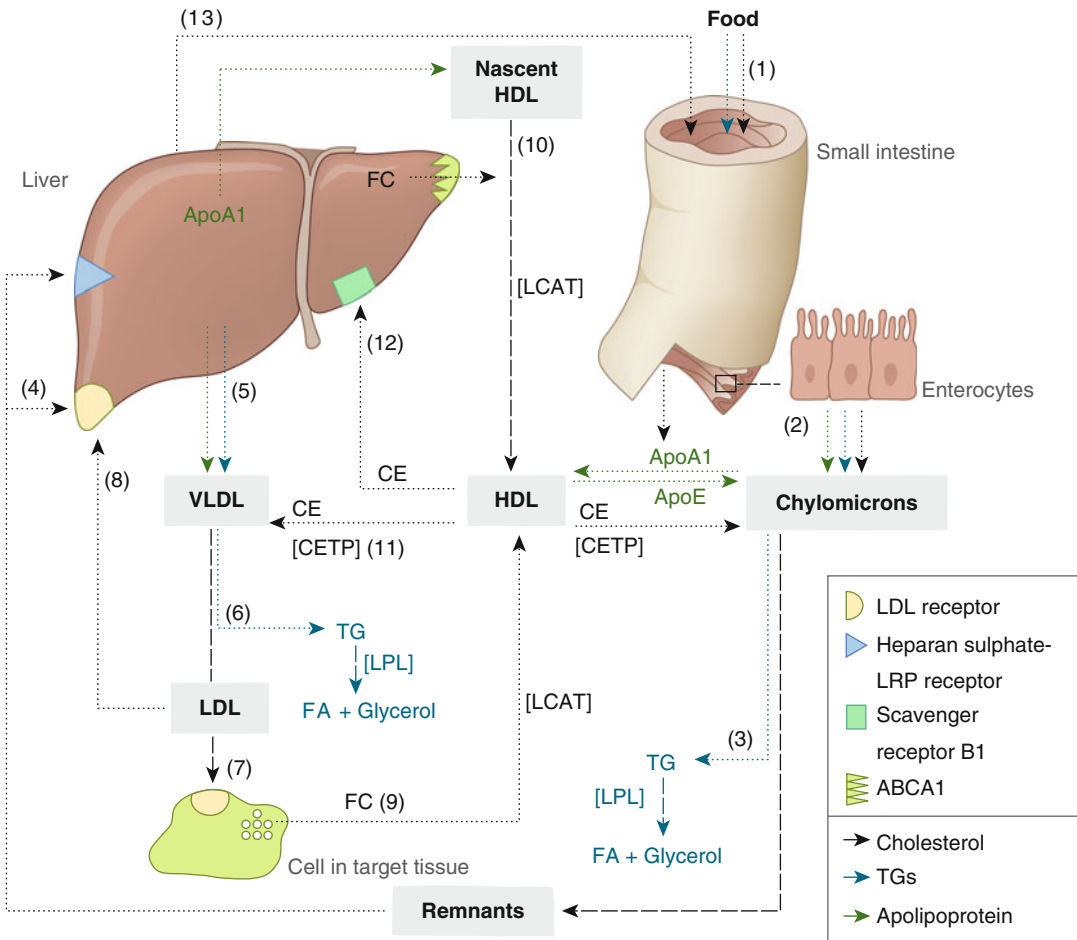

**Fig. 1** An outline of lipoprotein metabolism. (1) Food containing lipids (including fatty acids and cholesterol) as energy source and structural components of the body are ingested and absorbed. (2) Triglycerides (TGs), cholesterol, phospholipids, and apolipoproteins B48 (apoB48) and A1 are released from enterocytes as chylomicrons in the lymphatic flow. Blue arrows indicate flow of TGs, black arrows indicate flow of cholesterol or its derivatives, and green arrows indicate flow of apos. (3) In the capillary endothelium of various tissues, lipoprotein lipase (LPL) releases TGs from chylomicrons and generates free fatty acids (FA) and glycerol. Continuation of this process yields remnants consisting primarily of cholesterol. (4) The remnants are taken up by the liver via low-density lipoprotein (LDL) receptors (using apoE) or the heparan sulfate-LRP receptor. (5) The liver synthesizes very-low-density lipoproteins (VLDL) to carry TGs to target tissues. VLDLs also contain apoB100. (6) Removal of TGs from VLDL or uptake of cholesteryl esters (see below) creates LDLs, rich in cholesterol. (7) LDLs are taken up by cells

in target tissues to deliver cholesterol to sites of need. This requires apoB100. (8) LDLs can be transported back to the liver and are taken up via similar receptors, using apoB100. (9) Excess free cholesterol (FC) is transported from the tissues to the liver via high-density lipoprotein (HDL). Lecithin-cholesterol acyltransferase [LCAT] is required to integrate cholesterol and enlarge HDLs. (10) HDLs originally are created from the liver and contain apoA1 from the liver or small intestine and FC from the liver. FCs were exported using the ATP-binding cassette transporter (ABCA) 1, also known as cholesterol efflux regulating protein. (11) HDL transfers cholesterol to VLDL and chylomicrons as cholesteryl esters (CE) with the help of cholesteryl ester transfer protein (CETP). (12) CE are cleared from HDLs in the liver via scavenger receptors. (13) Finally, cholesterol can be converted to bile acids in the liver to remove cholesterol from the body. Bile is excreted into the small intestine where it also aids in the uptake of lipids, closing the circle. LRP low-density lipoprotein receptor-related protein

remnants. These remnants carry cholesterol absorbed from the gut and transferred from smaller lipoproteins by cholesteryl ester transfer protein (CETP, see below). They are removed from the circulation via the liver [2, 3]. This receptor-mediated clearance depends on apoE on the remnants, which is acquired from HDLs (Fig. 1). In health, the whole process occurs within a few hours of ingesting food.

### Very-Low-Density Lipoprotein

VLDLs are triglyceride-rich lipoproteins secreted by the liver. The major role of VLDL is to transport endogenously produced TGs to the target tissues. Its TGs, like those of chylomicrons, are removed during circulation by LPL displayed on the capillary endothelium of adipose tissue, skeletal and cardiac muscle, and lactating breast.

### Low-Density Lipoprotein

Removal of TGs and/or uptake of cholesterol via CETP convert VLDL to a cholesterol-rich smaller lipoprotein termed low-density lipoprotein (LDL). LDL crosses the capillary endothelium and supplies cholesterol to the tissues by endocytosis after binding to cell-surface LDL receptors, which are expressed when cholesterol is required for membrane growth, for repair, or for steroid synthesis. Thus, LDL delivers cholesterol to the tissues.

The liver also expresses LDL receptors and is the major organ of LDL catabolism in adulthood. Cholesterol entering liver by this route can be eliminated as biliary cholesterol or bile salts.

LDL can also enter macrophages located in the arterial wall contributing to atherosclerosis (see chapter “[Atherosclerotic heart disease](#)”). These macrophages are derived from blood monocytes crossing the vascular endothelium. In the arterial subintima these macrophage-monocytes take up LDL to become foam cells initiating fatty streak formation [2]. Subsequently,

an atheroma develops with a fibrous cap overlying a cholesterol lake formed by necrosis and apoptosis of foam cells. Foam cells can also produce collagenase, which contributes to the likelihood of atheromatous lesions rupturing in regions where foam cells are active. Thrombosis on the ruptured surface of atheroma is a major cause of acute cardiovascular events, such as acute coronary syndrome and stroke.

LDL must, however, undergo atherogenic modification such as oxidation, glycation, or glycoxidation before its uptake by macrophage scavenger receptors is rapid enough for foam cell formation.

### High-Density Lipoprotein and Reverse Cholesterol Transport

High-density lipoprotein (HDL) is the principal route for transporting cholesterol from tissues to the liver. It is the smallest and most abundant lipoprotein. HDL is rich in phospholipids and cholesterol. It receives excess cholesterol from peripheral tissues and free cholesterol exported from the liver and protects LDL from chemical modifications [2, 4]. Normally, free cholesterol is esterified by LCAT in the outer layer of the HDL, allowing entrance to the hydrophobic particle core, permitting further uptake of free cholesterol into its surface. Without this process, HDL cannot enlarge sufficiently to escape filtration and loss through the kidneys [2]. Physiologically, cholesteryl ester can be cleared from HDL via scavenger receptor B1 in the liver or transferred to larger lipoproteins, via CETP [2, 4].

### Apolipoproteins

The apoB proteins are essential for the assembly and release of chylomicrons and VLDL by gut and liver, respectively. More specifically, apoB48 is produced by the small intestine and is present in chylomicrons, where it is important for efficient lipid



absorption, chylomicron formation, and metabolism. ApoB100 produced by the liver is present on VLDL and LDL and mediates binding to the LDL receptor on hepatocytes leading to LDL clearance.

As apoE also binds to the LDL receptor, chylomicron remnants can, despite their lack of apoB100, be cleared by LDL receptor as well as by a multiligand receptor (heparan sulfate-low density lipoprotein receptor-related protein, see Fig. 1). ApoA1 is the main apolipoprotein in HDL and is secreted by hepatocytes and intestinal enterocytes. ApoA1 is important for the structural integrity and function of HDL, including the receptor-mediated release of cholesteryl ester to hepatocytes during its passage through the liver.

### Various Hyperlipidemias, Molecular Origin, and Changes in Metabolism

Several disorders are grouped under the term “hyperlipidemia” (Table 1) [1, 2, 5, 6].

Increased LDL cholesterol (LDLc, 2 mmol/l) presents a major risk factor for cardiovascular disease (CVD) in western societies, where even the mean values are unhealthy (common hypercholesterolemia, see Table 1). This does not cause immediate clinical features but can result in corneal arcus, a peripheral corneal opacity.

Hypertriglyceridemia (increase in serum TGs, HTG, 1.7 mmol/l) occurs independently or combined with raised LDLc.

### Polygenic Hyperlipidemias

The great majority of hyperlipidemia patients harbor polymorphisms predisposing them to raised LDLc, which only manifests when combined with nutritional excess [2–8]. Both, obesity and high-fat/cholesterol intake increase the likelihood of raised LDLc.

When HTG occurs on its own and in combination with hypercholesterolemia within

**Table 1** The hyperlipidemias

Lipoprotein disorder	Frequency	Cause	Inheritance	Clinical features
Common hypercholesterolemia (LDLc >2 mmol/l)	In >50 % of adults, significance depends on CVD risk	Obesity, high fat diet	Polygenic <sup>a</sup>	Generally none, xanthelasmata, corneal arcus
Combined hyperlipidemia/metabolic syndrome <sup>b</sup> (TGs >1.7 mmol/l)	1 in 50, significance depends on CVD risk	Obesity, high fat diet, insulin resistance	Polygenic <sup>a</sup>	Generally none, xanthelasmata, corneal arcus
Heterozygous familial hypercholesterolemia (LDLc >2 mmol/l)	1 in 500	Decreased LDL catabolism	Monogenic autosomal dominant (LDL receptor, ApoB or PCSK9 mutations)	None in younger people; CHD, corneal arcus xanthelasmata, tendon and sub-periosteal xanthomata
Remnant removal disease	1 in 5,000	Decreased catabolism of chylomicron remnants	Monogenic (generally recessive <i>ApoE</i> variant)	Xanthomata, CHD, peripheral artery disease
Severe hypertriglyceridemia (TGs >10 mmol/l)	1 in 1,000	Decreased chylomicron and VLDL catabolism	Commonly polygenic	Milky serum, xanthomata, hepatosplenomegaly, eruptive xanthoma, acute pancreatitis

CVD cardiovascular disease, *PCSK9* proprotein convertase subtilisin/kexin type 9, *VLDL* very-low-density lipoprotein  
<sup>a</sup>Nutrition interacts with more than one gene, less prevalent in regions where coronary heart disease (CHD) is uncommon

<sup>b</sup>Familial combined hyperlipidemia: raised low-density lipoprotein cholesterol (LDLc) and raised triglycerides (TGs) running together in same family



a family, it is termed familial combined hyperlipidemia. HTG is a major component of metabolic syndrome and type 2 diabetes mellitus (T2DM, see chapters “[Diabetes mellitus](#)” and “[Metabolic syndrome](#)”). People with raised TGs typically have low levels of HDL cholesterol (HDLc), raised blood pressure, and an increased likelihood of developing T2DM. Typically, they also have increased levels of a small dense LDL. Hyperlipidemia in T2DM was formerly thought to be secondary, but now T2DM should be viewed as part of a dyslipidemic syndrome.

### Familial Hypercholesterolemia

The most common monogenic cause of raised serum cholesterol is heterozygous familial hypercholesterolemia (HeFH, Table 1). It is dominantly inherited, and in these patients, cholesterol levels are doubled compared to healthy relatives, right from birth, and, thus, HeFH can be diagnosed in childhood [8–10]. Untreated, it results in xanthomata (depositions of cholesterol and fibrous tissue) in tendons. HeFH also increases CVD risk. Many patients die from ischemic heart disease before the age of 60 years [2, 10].

HeFH results from defective hepatic LDL catabolism, mostly due to a mutation of the LDL receptor, more rarely an apoB100 mutation or of the proprotein convertase subtilisin/kexin type 9 (PCSK9) gene [2, 10]. Gain-of-function mutations of PCSK9, which is involved in the degradation of hepatic LDL receptors, cause an unusually severe phenotype. In contrast, PCSK9 variants with impaired function result in longevity due to lower LDLc and reduced CVD risk [8].

Expression of HeFH does not require obesity. Affected individuals often appear lean and physically fit.

In homozygous familial hypercholesterolemia, both alleles of the LDL receptor gene have a mutation, and LDL cholesterol is greatly increased. However, this disease is extremely rare (1 in 10<sup>6</sup> individuals) unless there is consanguinity.

### Remnant Removal Disease

Hypercholesterolemia associated with marked HTG occurs in remnant removal disease (Table 1), in which chylomicron remnants accumulate in the circulation producing subcutaneous xanthomas located over the tuberosities and palmar skin creases. It greatly increases the risk of CVD [2, 3]. Remnant removal disease results from genetic variants of apoE with diminished receptor binding, as apoE plays a major role in the hepatic uptake and catabolism of remnant particles. Obesity is often present, and remnant removal disease is rare in women before the menopause.

### Severe Hypertriglyceridemia (HTG)

Severe HTG occurs when the capacity of LPL to clear TGs from chylomicrons and VLDL in the circulation is exceeded because of their increased production or due to mutations of LPL genes [2, 11]. Most commonly, it appears as a combination of a genetic variant with factors raising TGs (high-fat diet, obesity, type 2 diabetes, high alcohol consumption) and/or compromising LPL function (insulin deficiency or resistance, hypothyroidism,  $\beta$ -adrenoceptor blockade). More rarely, it is autosomal recessive, and both LPL genes have a mutation.

Serum and plasma appear milky. Severe HTG is associated with increased risk of acute pancreatitis, hepatosplenomegaly, and eruptive xanthomata.

### Secondary Hyperlipidemia

Hyperlipidemia secondary to other diseases is common in many morbidities. T1DM and T2DM are associated with HTG (see above). In T1DM, insulin treatment tends to restore TGs level to normal. HTG is also caused by high alcohol consumption, by chronic renal insufficiency, and by parenchymal liver disease. Hyperuricemia and gout (see chapter [Gout and hyperuricemia](#)) are strikingly associated with most forms of HTG. The reason is not entirely clear. One hypothesis points

to carbohydrates (e.g., fructose), which may induce HTG and may also raise serum urate levels.

Hypothyroidism can cause both hypercholesterolemia because of decreased receptor-mediated LDL catabolism and HTG because of decreased TGs clearance, probably mediated via decreased LPL activity. Nephrotic syndrome raises LDLc. Obstructive liver disease is also associated with high cholesterol, but this is because of an abnormal, pathological lipoprotein (called LpX), which interferes with the uptake of chylomicron remnants. LpX occurs when there is reflux of biliary phospholipids into the circulation as a result of obstruction.

Other inherited disturbances of lipoprotein metabolism include LCAT deficiency, a cause of low HDL, corneal opacity, and proteinuria and alpha-lipoproteinemia, in which a mutation of ABCA1 (also known as “cholesterol efflux regulating protein”) prevents the egress of free cholesterol from the liver leading to almost absent HDL, splenomegaly, and occasionally orange-yellow cholesterol deposits in the tonsils and rectal mucosa. In contrast, in familial CETP deficiency, HDLc levels are high, and the HDL particles enlarged.

---

## Treatment of Hyperlipidemias

Treatment generally aims at a reduction of LDL cholesterol (below 2 mmol/l, or even further in high-risk patients to avoid CVD) [9, 10, 12, 13]. Lowering TGs serum levels below 10 mmol/l is important to avoid acute pancreatitis.

### Dietary Treatment

All obese hyperlipidemic patients benefit from weight loss. Dietary saturated fat and cholesterol should be avoided, to prevent a rise in LDL cholesterol; sometimes all fat should be restricted to avoid chylomicron formation.

### Drug Treatment

Initiation of lipid-lowering medication in primary prevention is mainly based on LDL cholesterol

levels and future risk of atherosclerotic CVD events [10, 12, 13]. In patients with established atherosclerotic CVD, diabetes mellitus, monogenic hyperlipidemia, and severe HTG, drug treatment is indicated without multifactorial risk evaluation. Lipid modification therapies are contraindicated during pregnancy and breastfeeding.

---

## Molecular Mechanism and Influence on Metabolism of the Most Common Lipid-Lowering Drugs

### Statins

Statins inhibit 3-hydroxy-methyl-glutaryl-CoA reductase mostly in the liver. This is the rate-limiting enzyme for cholesterol biosynthesis. The resulting decrease in intrahepatic cholesterol leads to enhanced hepatic LDL receptor expression and thus a decrease in circulating LDLc [14]. They decrease CVD risk by about one fifth for every 1 mmol/l decrease in LDL cholesterol, irrespective of LDL cholesterol levels, making them the most effective means of preventing CVD [15]. Myositis (muscle inflammation) can occasionally be a side effect, as can muscle aching and elevations of creatine kinase, which may affect patient compliance. Co-treatment with agents, such as macrolide antibiotics, which compete for the same degrading enzymes as statins, should be avoided. Grapefruit juice should be avoided for the same reason. Statins are also prescribed for patients with HTG and/or low HDLc as they decrease CVD even when LDLc is not the principal disorder.

### Ezetimibe

Ezetimibe is generally well tolerated but is a less effective LDL-lowering agent than most statins. It acts by inhibiting intestinal cholesterol absorption, which includes both the dietary cholesterol and also that entering the intestine in the bile, which would otherwise largely be reabsorbed. It does so by binding to Niemann-Pick C1-like 1, a critical mediator of cholesterol absorption in the gut. It has its greatest clinical utility as an

adjunct to statin therapy in patients with particularly high LDL levels but can also be used to replace statin therapy wholly or in part in high-risk patients who are truly statin intolerant.

### Bile Acid Sequestering Agents

Bile acid sequestering agents impede the reabsorption of bile acids from the terminal ileum thereby increasing the hepatic need for cholesterol for the synthesis of bile acids. Enhanced hepatic cholesterol uptake is mediated by increased LDL receptor expression, thereby lowering circulating LDL. However, these drugs are poorly tolerated except at low dose when they are no more effective than ezetimibe.

### Other Lipid-Lowering Drugs

Other lipid-lowering drugs, such as fibric acid derivatives and nicotinic acid, are used to lower triglycerides and raise HDLc. However, their efficacy in decreasing CVD events is controversial.

Purified  $\omega$ 3 fatty acids can decrease TGs and CVD risk. Their mechanism of action is not completely understood. Potential mechanisms of action include inhibition of acyl CoA:1,2-diacylglycerol acyltransferase and increased peroxisomal  $\beta$ -oxidation in the liver. It should be remembered that they contribute to chylomicron formation and are readily oxidizable at their double bonds.

### Perspectives

Although LDLc lowering with statins has reduced CVD events significantly, a substantial residual risk remains and some patients are intolerant to statins most commonly due to myalgia (muscle pain). Therefore, there is a need for more therapeutic options especially for severe and genetic hyperlipidemias. Novel pharmaceutical approaches, including the inhibition of CETP, of apoB100 synthesis, and of PCSK9 and intravenously administered HDL mimetics, are currently being explored.

### References

1. Durrington PN (2003) Seminar: dyslipidaemia. *Lancet* 362:717–731
2. Durrington PN (2007) *Hyperlipidaemia. Diagnosis and management*, 3rd edn. Hodder Arnold, London
3. Critchley J, Liu J, Zhao D, Wei W, Capewell S (2004) Explaining the increase in coronary heart disease in Beijing between 1984 and 1999. *Circulation* 110: 1236–1244
4. Patel JV, Vyas A, Cruickshank JK, Prabhakaran D, Hughes E, Reddy KS, Mackness MI, Bhatnagar D, Durrington PN (2006) Impact of migration on coronary heart disease risk factors: comparison of Gujaratis in Britain and their contemporaries in villages of origin in India. *Atherosclerosis* 185: 297–306
5. Rall SC, Mahley RW (2000) Type III hyperlipoproteinemia (dysbetalipoproteinemia): the role of apolipoprotein E in normal and abnormal lipoprotein metabolism. In: Scriver CR, Beaudet al, Sly WS, Valle D (eds) *Metabolic and molecular bases of inherited disease*, 7th edn. McGraw-Hill, New York, pp 2835–2862, Chapter 119
6. Rosenson RS, Brewer HB Jr, Davidson WS, Fayad ZA, Fuster V, Goldstein J, Hellerstein M, Jiang XC, Phillips MC, Rader DJ, Remaley AT, Rothblat GH, Tall AR, Yvan-Charvet L (2012) Cholesterol efflux and atheroprotection: advancing the concept of reverse cholesterol transport. *Circulation* 125: 1905–1919
7. Asselbergs FW et al (2012) Large-scale gene-centric meta-analysis across 32 studies identifies multiple lipid loci. *Am J Hum Genet* 91:823–838
8. Kotowski IK, Pertsemlidis A, Luke A, Cooper RS, Vega GL, Cohen JC, Hobbs HH (2006) A spectrum of PCSK9 alleles contributes to plasma levels of low-density lipoprotein cholesterol. *Am J Hum Genet* 78:410–422
9. Brown MS, Hobbs HH, Goldstein JL (2000) Familial hypercholesterolemia. In: Scriver CR, Beaudet al, Sly WS, Valle D (eds) *Metabolic and molecular bases of inherited disease*, 7th edn. McGraw-Hill, New York, pp 2863–2913, Chapter 120
10. National Institute for Health and Clinical Excellence (2008) Identification and management of familial hypercholesterolaemia. NICE Guideline 71. [www.nice.org.uk/nicemedia/pdf/CG071NICEGuideline.pdf](http://www.nice.org.uk/nicemedia/pdf/CG071NICEGuideline.pdf)
11. Brunzell JD, Deeb SS (2000) Familial lipoprotein lipase deficiency, apo C-II deficiency, and hepatic lipase deficiency. In: Scriver CR, Beaudet al, Sly WS, Valle D (eds) *Metabolic and molecular bases of inherited disease*, 7th edn. McGraw-Hill, New York, pp 2789–2816, Chapter 117
12. Adult Treatment Panel III (ATP III) of the National Cholesterol Education Program, ATP III Update (2004) Implications of recent clinical trials for the ATP III guidelines. <http://www.nhlbi.nih.gov/guidelines/cholesterol/atp3upd04.htm>

13. Catapano AL, Reiner Z, De Backer G, Graham I, Taskinen MR, Wiklund O, Agewall S, Alegria E, Chapman M, Durrington P, Erdine S, Halcox J, Hobbs R, Kjekshus J, Filardi PP, Riccardi G, Storey RF, Wood D (2011) ESC/EAS guidelines for the management of dyslipidaemias The Task Force for the management of dyslipidaemias of the European Society of Cardiology (ESC) and the European Atherosclerosis Society (EAS). *Eur Heart J* 32:1769–1818
14. Charlton-Menys V, Durrington PN (2008) Human cholesterol metabolism and therapeutic molecules. *Exp Physiol* 93:27–42
15. Cholesterol Treatment Trialists' (CTT) Collaborators (2012) The effects of lowering LDL cholesterol with statin therapy in people at low risk of vascular disease: meta-analysis of individual data from 27 randomised trials. *Lancet* 380:581–590

---

**Part XIII**

**Immune System**

---

# Overview

Christian Münz

---

## Anatomy and Physiology of the Immune System

The immune system is a complex network of metabolic pathways and cells, which are designed to distinguish harmful insults from harmless changes or fluctuations in metabolism and to mount an appropriate response to these harmful insults without compromising the affected tissue. Therefore, it walks a fine line to combat pathogens and cellular transformation on the one hand and to tolerate commensals on mucosal surfaces (such as normal gut bacteria), and food components, on the other hand.

Moreover, it has evolved to specifically meet the challenges of its respective host species concerning pathogens encountered in the ecological niche that the host occupies and during the time of reproduction that has to be protected to guarantee propagation of the species. Therefore, the differences even between closely related mammalian species are considerable, placing the immune system in third position of the most divergent organs between mouse and man [1, 2].

These challenges are met by the immune system with stringent education of its components to ignore the physiological state (which happens in

so-called primary lymphoid organs such as the thymus or bone marrow) and by integration of afferent information (which happens in immunological decision centers, the secondary and tertiary lymphoid tissues such as spleen or lymph nodes). Concomitantly, efferent responses (cellular and humoral) to target harmful insults are mounted.

All soluble factors directed at insults are called humoral immune responses. These include invariant molecules like antimicrobial peptides or the alternative pathway of complement system and molecules of the adaptive immune system, mainly antibodies. The complement activation is part of the innate immune system and establishes pores in targeted cells (cell lysis), enhances phagocytosis of antigens (opsonization), and attracts macrophages and neutrophils (chemotaxis).

Antibodies are selected from a large repertoire that is generated by (1) somatic DNA recombination and then further shaped to recognize the targeted antigen with higher affinity and (2) additional effector mechanisms such as somatic hypermutation and class switch recombination, producing different subtypes of immunoglobulins (Ig).

The cellular immune responses include activation of cytotoxic effector cells and phagocytes. Again these responses can be innate (including natural killer cells and pathogen recognition by phagocytes, such as macrophages, using scavenger receptors), or they can be adaptive (including cytotoxic T cells and

---

C. Münz  
Department of Viral Immunobiology,  
Institute of Experimental Immunology,  
University of Zürich, Winterthurerstrasse 190,  
Zürich CH-8057, Switzerland  
e-mail: [christian.muenz@uzh.ch](mailto:christian.muenz@uzh.ch)

T-cell activation of phagocytes). Therefore, the immune system has a large armamentarium to restore the healthy steady state.

---

## Specific Pathways and Metabolic Processes of the Immune System and Its Cells

### Primary Lymphoid Tissues

The main primary lymphoid tissues are the thymus and the bone marrow, where T cells and B cells (also known as T and B lymphocytes) are educated, respectively. T cells can detect changes (such as the presence of foreign proteins) inside cells, whereas B cells secrete effector molecules, mainly antibodies to target extracellular pathogens. Selectivity of T and B cells is achieved by somatic recombination of their respective antigen receptor genes, followed by a stringent selection process to ensure they carry functional receptors, which do not recognize self-structures, such as endogenous proteins or sugar moieties on the surface of host cells [3, 4].

B cells develop from hematopoietic precursors in the bone marrow and are deleted by apoptosis if they fail to generate a functional antibody on their surface (see below) and also if this antibody recognizes self-structures in the bone marrow.

T cells originate from precursors that also develop in the bone marrow, but then migrate to the thymus. There, only T cells continue to develop, whose T-cell receptors recognize major histocompatibility complex (MHC) molecules, which in humans are also called human leukocyte antigen (HLA) molecules. These scaffolding proteins display products of the protein and lipid catabolism of thymic epithelial cells to the T cells. After this positive selection, T cells are eliminated by negative selection if they strongly react to MHC molecules that present self-structures, thus generating a central tolerance. In general, both cluster of differentiation 4-positive (CD4<sup>+</sup>) T-helper (T<sub>h</sub>) cells and CD8<sup>+</sup> cytotoxic T cells develop that recognize foreign structures, in particular extracellular and intracellular peptides, on MHC class II and class I molecules, respectively.

### Secondary Lymphoid Tissues

Once the mature and educated T and B cells emerge from primary lymphoid organs, they home to secondary lymphoid organs like spleen, lymph nodes, tonsils, and gut mucosa-associated lymphoid tissues via the blood stream. In the secondary lymphoid organs, they extravasate from the blood in specialized endothelia, called high endothelial venules, in response to gradients of chemokines, attractants for migration, such as chemokine (C-C motif) ligand (CCL) 19 and 21 (Fig. 1).

For activation of T cells, processed foreign structures (mostly peptides) are presented on MHC molecules by dendritic cells (DCs) that have picked up these antigens at various sites of the body in order to carry them to secondary lymphoid tissues via afferent lymphatic vessels (Fig. 1) [5]. This antigen transport occurs from all organs, and therefore a dense network of secondary lymphoid tissues weaves through the body to keep the antigen transport times short. Once a T cell detects a specific antigen, it proliferates and differentiates.

T cells differentiate into effector cells, e.g., T<sub>h</sub>1, T<sub>h</sub>2, or T<sub>h</sub>17 cells, which secrete different sets of cytokines to communicate with other immune and somatic cells, or into memory cells, which will continue to migrate through secondary lymphoid tissues and promptly respond by proliferation and defense mechanisms, in case the antigen comes back (Fig. 1).

Upon activation by cognate antigen recognition, B cells enter germinal centers in secondary lymphoid tissues [6]. At these sites, they mature their antigen receptor by somatic hypermutation (called affinity maturation) in order to produce antibodies that bind foreign structures called antigens with higher avidity. At the same time, they switch their antibody molecule isotype, e.g., from IgM to IgG, allowing them to acquire additional effector functions, like binding to Fc receptors on phagocytes, follicular dendritic cells, or cytotoxic cells and complement fixation. Only if the altered antibody still recognizes the antigen (signal 1), e.g., presented bound to the complement or Fc receptors on follicular dendritic cells,



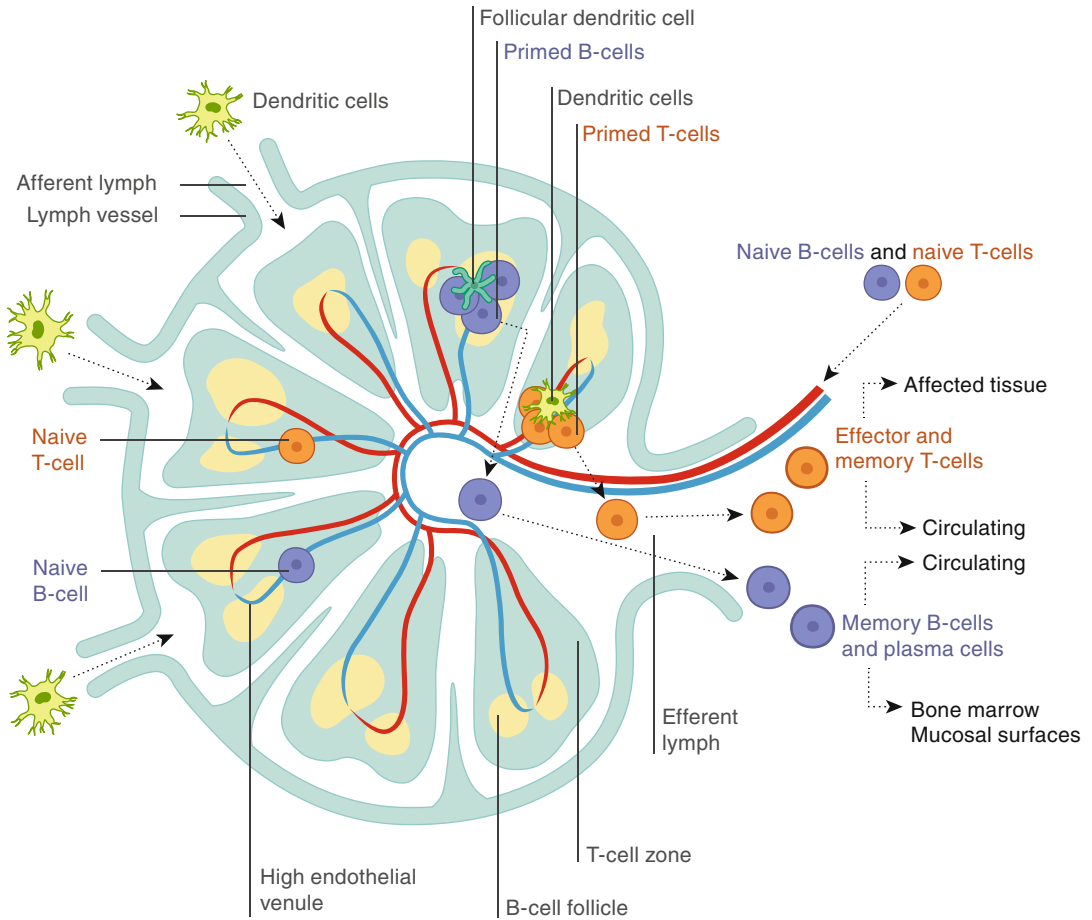

**Fig. 1** Schematic section through a lymph node, a secondary lymphoid organ. Information on the health of peripheral tissues is continuously reported to the lymph nodes in the form of the degree and quality of dendritic cell (DC) activation. Processed peptide antigens are presented on the major histocompatibility complex (MHC) molecules of DCs. Naive and memory T cells circulate through these organs via extravasation at high endothelial venules and exit through efferent lymph vessels. T cells get activated when their T-cell receptors bind to antigens on activated DCs. T cells get primed (see text), proliferate, and differentiate into effector or memory T cells. Effector T cells then home back to the diseased tissue to fight the infection or assist B cells in the germinal center. There,

antigen-stimulated B cells affinity mature their B-cell receptor, which will serve as blueprint for the antibody that will be later secreted by this B cell. The somatically mutated B-cell receptor has to still recognize the unprocessed, original antigen, bound on the surface of follicular DCs via complement or Fc receptors. The B cells still require T cell help (not shown). Only if these two checkpoints are passed, the activated B cell will go on to develop into a memory cell or an antibody producing plasma cell. These can also leave the lymph node via efferent lymph, and plasma cells often home to the bone marrow or mucosal surfaces. Note that the cells are displayed in higher magnification compared to the lymph node

and the B cell receives signals (“help”) from a T cell (that in most cases has to recognize the same antigen but in a processed form preferential on MHC molecules, signal 2), the B cell survives this germinal center reaction and can go on to develop into a memory B cell or an antibody-secreting plasma cell.

T and B cells emigrate from secondary lymphoid tissues via the efferent lymphatics to the sites of the harmful insult guided by chemokine gradients, like the chemokine (C-X-C motif) ligand (CXCL) 9 and CXCL10 (Fig. 1). This process of immune response initiation is called priming.

## Tertiary Lymphoid Tissues

In order to keep the distances for immune cell migration short and therefore the response time to a minimum, tertiary lymphoid tissues develop at sites of chronic immune cell infiltrates and inflammation [7]. These are similar in structure and function to secondary lymphoid tissues.

---

## Outside-In: Communication of Stromal Cells with Immune Cells

The afferent arm of immune responses is mainly represented by DCs, which continuously report the immunological health of organs to secondary lymphoid tissues by transporting organ constituents and the conditions, under which they have acquired these as their surface molecule phenotype and cytokine secretion pattern. They can detect pathogens in all organs directly via receptors for pathogen-associated molecular patterns (PAMPs), such as bacterial cell wall components, viral unmethylated DNA, and viral RNA, which activate them. Alternatively, they can also detect organ or tissue destruction indicated by the release of danger-associated molecular pattern (DAMPs) [8, 9], like ureate crystals as well as extracellular high mobility group B1 protein and ATP release (Fig. 2). Some of these are recognized by inflammasomes, of which the NLRP3 containing protein complex is the best studied [8]. Their activation allows interleukin 1 (IL-1) production, which is the main mediator of inflammation causing heat, redness, pain, swelling, and loss of tissue function. Both, PAMPs and DAMPs, thus activate DC migration and immune response priming in secondary lymphoid organs. In addition, stromal cells can communicate with DCs via chemokines and cytokines. Therefore, the input by the organ environment is crucial for the afferent communication of the immune system with secondary lymphoid organs.

---

## Inside-In: Communication Between Immune Cells

Chemokines (chemotactic cytokines), such as CXCL9 and CXCL10, are produced to build gradients in tissues to attract immune cells such as

effector T cells. Immune cells (such as macrophages and T cells) communicate with each other and stromal cells through surface receptors that accumulate at membrane contact areas, so-called immunological synapses. Cytokines, e.g., interferon  $\gamma$  (IFN $\gamma$ ), are secreted into these synapses or to neighboring cells to further refine the communication between immune cells.

Three signals constitute the core of the communication between immune cells, which primarily happens in secondary lymphoid tissues between antigen carrying DCs and responding T cells (Fig. 2). The first signal is the presentation of catabolic products of antigens (mainly peptides) by DCs on MHC molecules to the T-cell receptor of T cells. These peptides originate from the two main proteolytic machineries of the cell, i.e., lysosomes and proteasomes [10]. Proteasomal products are presented on MHC class I molecules to cytotoxic CD8<sup>+</sup> T cells, whereas lysosomal products are presented on MHC class II molecules to helper CD4<sup>+</sup> T cells, which assist maintenance and differentiation of both primed CD8<sup>+</sup> T and B cells. This first signal induces proliferation of T cells, only if co-stimulatory signals (see below) are present. If these signals are absent, the antigen-specific T cells are eliminated after a few cell divisions, a process contributing to peripheral tolerance [11].

Thus, activated DCs save the proliferating T cells from dying by releasing cytokines and other co-stimulatory molecules, like IL-12 and IL-15, toward them, and shape their profile [12]. These cytokines imprint information about the conditions, under which DCs have been activated, onto the responding T cell. For example, IL-12 favors the development of T<sub>h</sub>1 polarized T cell responses and is mainly secreted by DCs after virus encounter. A T<sub>h</sub>1 response can trigger the destruction of virus-infected cells by cytotoxic T cells. Furthermore, this so-called polarization also gives CD4<sup>+</sup> T cells a certain profile of chemokine receptors that will direct them to the tissues, in which the DCs had been activated. For example, the C-C chemokine receptor type 9 is required for homing CD4<sup>+</sup> T cells to the gut [13], while CD8<sup>+</sup> T cells acquire a less variant chemokine receptor repertoire that will direct them to sites of inflammation. There, a tailored response is mounted, including the

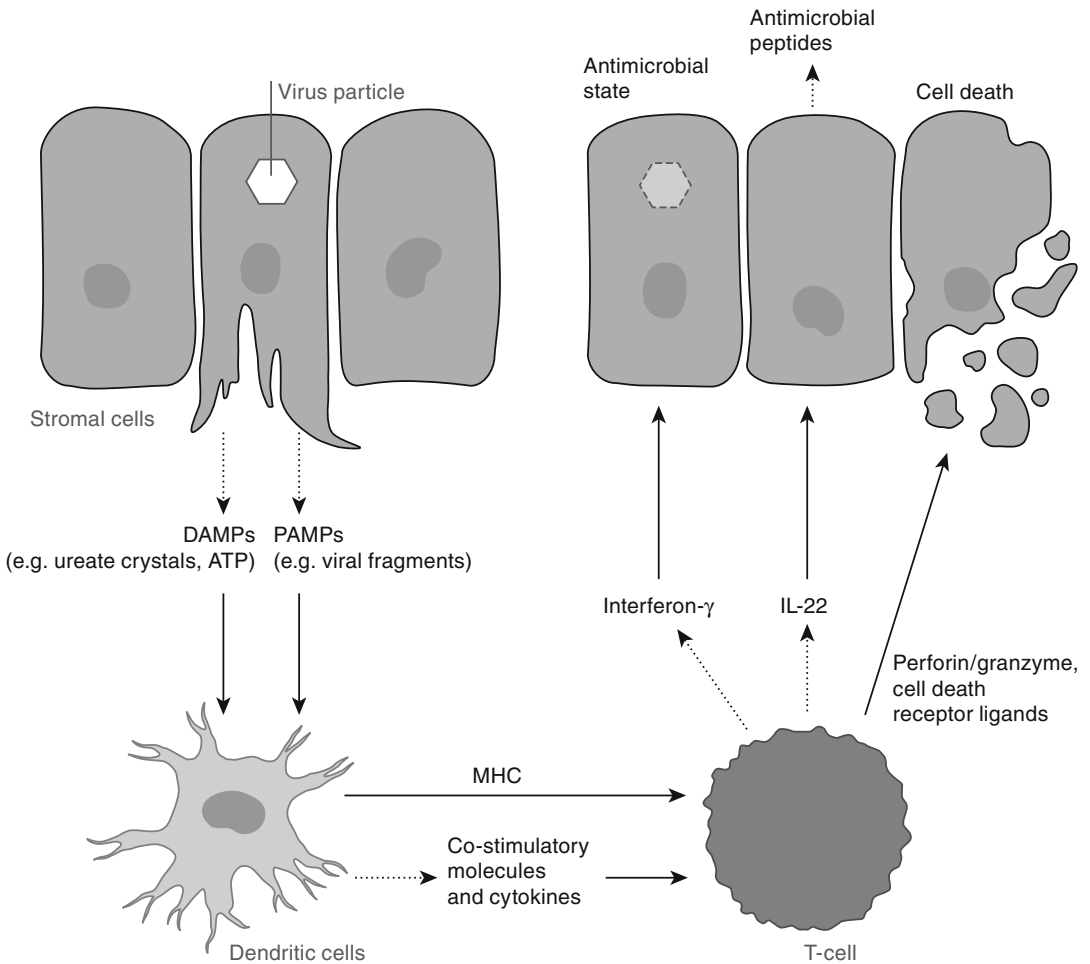

**Fig. 2** Schematic pathway of dendritic cell and T-cell activation and subsequent cellular changes. The immune system receives cues from all organs. Stromal cells in an inflamed or infected tissue can activate dendritic cells through the release of danger- (*DAMPs*) and, if infected, pathogen-associated molecular patterns (*PAMPs*), which are, e.g., contained in necrotic cellular debris. Once activated, dendritic cells can prime T cells in secondary or

tertiary lymphoid tissues. The T cells then home to the tissue to change its intracellular milieu and its secretome via interferon (*IFN*) and interleukin (*IL*) secretion, e.g., IL-22 and IFN $\gamma$ . Primed T cells also influence the survival of the cells within an inflamed tissue via cell-contact-dependent cytotoxicity, e.g., via perforin/granzyme or apoptosis-inducing ligands

secretion of cytokines, acting on the infected or transformed tissue, e.g., IFN $\gamma$  to inhibit viral replication, and the expression of cytotoxic molecules, e.g., perforin-1, to directly destroy the diseased cells.

Distinct metabolic pathways, such as macroautophagy [14], are required for T-cell proliferation [15], which also occurs locally in infected tissues, presumably to further amplify the T-cell response. Oxidative phosphorylation generates most ATP in resting T cells. However, activated T cells dramatically increase their rates

of glycolysis and lactate production. Importantly, glucose is strictly required for T-cell proliferation and cytokine production, even when other metabolic substrates such as glutamine or fatty acids are present, likely due to the ability of glucose metabolism to consistently generate ATP and NADPH and stabilize antiapoptotic proteins [16]. Moreover, aerobic glycolysis is necessary for T-cell effector function, in particular for IFN $\gamma$  production [17]. Finally, whereas most T cells rely on glycolysis, a subset of T cells (such as regulatory T cells, also called T<sub>reg</sub>, or CD8<sup>+</sup>

memory T cells) requires fatty acid oxidation, showing that energy metabolism influences immune responses [16].

---

### Inside-Out: Communication of Immune Cells with Stromal Cells

The effector molecules from polarized T cells are then able to change tissue homeostasis in the inflamed and/or infected organs, from which the DCs carried the antigens to the secondary lymphoid organs. A wide variety of responses can be elicited, ranging from metabolic changes in target cells to release of antimicrobial peptides, or to induction of apoptosis. Metabolic changes aim to make cells less hospitable for infectious agents and reduce pathogen replication. For example, IFNs can induce an antiviral state in part by inhibiting anabolic pathways required for virus production [18]. Secretion of antimicrobial peptides by epithelial cells at mucosal surfaces is stimulated by IL-22, which is either secreted by innate lymphoid cells or T<sub>H</sub>17 polarized CD4<sup>+</sup> T cells [19]. Cell death can be triggered by cytotoxic CD8<sup>+</sup> T cells via perforin-mediated granzyme injection into an infected target cell. During this process, at least one of the cell death initiating proteases of the granzyme family enters the target cell through pores that are formed by perforin. Alternatively, a cytotoxic T cell kills an infected or transformed cell by activation of its cell death receptors (Fig. 2) [20]. Thus, immune cells can dramatically change cellular physiology within an inflamed organ.

### Miscommunication in the Immune System as the Basis of Disease

The borderline between hyporesponsiveness of the immune system resulting in susceptibility to disease [21] and hyperresponsiveness leading to immunopathology and autoimmunity [22] is not easily defended by the immune system and drawn by the genetic makeup of the individual. Any significant insult that releases DAMPs can change the organ environment and metabolism so that it is no

longer recognized as self by the immune system. This is in part explained by the circumstance that the lymphocytes were educated toward a different steady state. Sometimes the resulting autoimmune responses are transient, just causing immunopathology during the infectious or traumatic insult. However, sometimes, but fortunately rarely, they result in self-perpetuating autoimmune disease [22], depending in part on the genetic variation of the affected individuals (see, e.g., chapters “[Rheumatoid arthritis](#)” and “[Diabetes mellitus](#)”).

---

### Final Remarks

The key physiological function of the immune system is to defend multicellular organisms against harmful “nonself” by transporting information from organs to secondary lymphoid tissues and mounting immune responses when this information indicates infection or tissue damage. Both overshooting (see chapter “[Rheumatoid arthritis](#)”) and too cautious immune reactions (see chapter “[Community-acquired pneumonia](#)”) lead to disease and are caused by the combination of the individual’s genetic predisposition and the environmental conditions.

---

### References

1. Waterston RH, Lindblad-Toh K, Birney E, Rogers J, Abril JF, Agarwal P et al (2002) Initial sequencing and comparative analysis of the mouse genome. *Nature* 420:520–562
2. Seok J, Warren HS, Cuenca AG, Mindrinos MN, Baker HV, Xu W, Richards DR, McDonald-Smith GP, Gao H, Hennessy L, Finnerty CC, López CM, Honari S, Moore EE, Minei JP, Cuschieri J, Bankey PE, Johnson JL, Sperry J, Nathens AB, Billiar TR, West MA, Jeschke MG, Klein MB, Gamelli RL, Gibran NS, Brownstein BH, Miller-Graziano C, Calvano SE, Mason PH, Cobb JP, Rahme LG, Lowry SF, Maier RV, Moldawer LL, Herndon DN, Davis RW, Xiao W, Tompkins RG (2013) Genomic responses in mouse models poorly mimic human inflammatory diseases. *Proc Natl Acad Sci U S A* 110:3507–3512
3. Kyewski B, Klein L (2006) A central role for central tolerance. *Annu Rev Immunol* 24:571–606
4. Jankovic M, Casellas R, Yannoutsos N, Wardemann H, Nussenzweig MC (2004) RAGs and regulation of autoantibodies. *Annu Rev Immunol* 22:485–501

5. Cyster JG (2005) Chemokines, sphingosine-1-phosphate, and cell migration in secondary lymphoid organs. *Annu Rev Immunol* 23:127–159
6. Victora GD, Nussenzweig MC (2012) Germinal centers. *Annu Rev Immunol* 30:429–457
7. van de Pavert SA, Mebius RE (2010) New insights into the development of lymphoid tissues. *Nat Rev Immunol* 10:664–674
8. Martinon F, Mayor A, Tschopp J (2009) The inflammasomes: guardians of the body. *Annu Rev Immunol* 27:229–265
9. Sims GP, Rowe DC, Rietdijk ST, Herbst R, Coyle AJ (2010) HMGB1 and RAGE in inflammation and cancer. *Annu Rev Immunol* 28:367–388
10. Trombetta ES, Mellman I (2005) Cell biology of antigen processing in vitro and in vivo. *Annu Rev Immunol* 23:975–1028
11. Steinman RM, Hawiger D, Nussenzweig MC (2003) Tolerogenic dendritic cells. *Annu Rev Immunol* 21:685–711
12. Steinman RM (2012) Decisions about dendritic cells: past, present, and future. *Annu Rev Immunol* 30:1–22
13. Sallusto F, Mackay CR, Lanzavecchia A (2000) The role of chemokine receptors in primary, effector, and memory immune responses. *Annu Rev Immunol* 18:593–620
14. Münz C (2009) Enhancing immunity through autophagy. *Annu Rev Immunol* 27:423–429
15. Gerriets VA, Rathmell JC (2012) Metabolic pathways in T cell fate and function. *Trends Immunol* 33:168–173
16. Wahl DR, Byersdorfer CA, Ferrara JL, Opipari AW Jr, Glick GD (2012) Distinct metabolic programs in activated T cells: opportunities for selective immunomodulation. *Immunol Rev* 249:104
17. Chang CH, Curtis JD, Maggi LB Jr, Faubert B, Villarino AV, O’Sullivan D, Huang SC, van der Windt GJ, Blagih J, Qiu J, Weber JD, Pearce EJ, Jones RG, Pearce EL (2013) Posttranscriptional control of T cell effector function by aerobic glycolysis. *Cell* 153:1239–1251
18. MacMicking JD (2012) Interferon-inducible effector mechanisms in cell-autonomous immunity. *Nat Rev Immunol* 12:367–382
19. Sonnenberg GF, Fouser LA, Artis D (2011) Border patrol: regulation of immunity, inflammation and tissue homeostasis at barrier surfaces by IL-22. *Nat Immunol* 12:383–390
20. Lopez JA, Brennan AJ, Whisstock JC, Voskoboinik I, Trapani JA (2012) Protecting a serial killer: pathways for perforin trafficking and self-defence ensure sequential target cell death. *Trends Immunol* 33:406–412
21. Casanova JL, Abel L, Quintana-Murci L (2011) Human TLRs and IL-1Rs in host defense: natural insights from evolutionary, epidemiological, and clinical genetics. *Annu Rev Immunol* 29:447–491
22. Münz C, Lunemann JD, Getts MT, Miller SD (2009) Antiviral immune responses: triggers of or triggered by autoimmunity? *Nat Rev Immunol* 9:246–258

---

# Fever

Bruno Conti and Tamas Bartfai

---

## Introduction to Fever

Although fever is not considered a disease, it is probably the most commonly used quantitative parameter to determine the occurrence of a pathological condition and changes in a disease state as it is typically triggered by infection or by inflammation often associated with diseases.

Fever or pyrexia (from Latin *febris* or Greek *purexis*, related to heat) is the regulated elevation of core body temperature (CBT) above the value considered normal. In humans, an increase of temperature above 37 °C is typically regarded as fever. However, it is important to note that not all temperature increases above this value are to be considered fever and, by contrary, there may be febrile conditions with temperature elevation reaching values lower than 37 °C. In fact, regular CBT is subject to individual variation and can be affected by several conditions including time of the day, exercise, feeding, sleep, hormonal changes and also age, with fluctuations typically occurring in the range of 36.5–37.5 °C. For this reason, individuals with lower base CBT can mount a fever response with temperature values

typically considered normal. This often occurs in the elderly that tend to have lower CBT and reduced thermogenic ability. It is also important to remember that temperature readings vary depending on the methods and the site of measurement. Throughout the following chapter we refer to CBT as the temperature of the core of the body surrounding the vital organs (the trunk and the brain), whereas clinically temperature is measured more peripherally.

As a first approximation, fever results from the elevation of the individual temperature “set point” of the internal “thermostat.” Although the existence and the nature of such a set point is subject of discussion, the preoptic area in the hypothalamus possesses the features of a bona fide thermostat. In fact, this region is capable of sensing local temperature and receives information from peripheral temperature sensors. It integrates the information and activates the effector responses to maintain temperature homeostasis. The hypothesis is that this endogenous thermostat has a “set point” and that fever results from raising its value. First, the hypothesis allows understanding why fever is associated with chills (a feeling of being cold even if CBT is raising) that will persist until CBT has reached the new setting. Second, it exemplifies the important difference of fever and hyperthermia, as the latter is an uncontrolled increase in heat production by the effector organs that occurs independently of the set point, which remains unchanged.

---

B. Conti (✉) • T. Bartfai  
Department of Chemical Physiology,  
The Scripps Research Institute, 10550 North Torrey  
Pines Road, La Jolla, CA 92121, USA  
e-mail: [bconti@scripps.edu](mailto:bconti@scripps.edu); [tbartfai@scripps.edu](mailto:tbartfai@scripps.edu)

## Physiology of Fever

### Mechanisms of Fever

Fever is triggered when endogenous or exogenous pyrogens stimulate the synthesis of prostaglandin  $E_2$  ( $PGE_2$ , Fig. 1) [1]. Synthesized in endothelial cells of the brain vasculature or in circulating macrophages in response to immune signals,  $PGE_2$  mediates fever when it binds the prostaglandin E receptor 3 on neurons in the preoptic area (Fig. 1) [2]. Some of these neurons project to at least two other regions known as dorsomedial hypothalamus and raphe pallidus and form part of a circuitry that controls thermogenesis by innervating peripheral tissues capable of generating heat. These include the brown adi-

pose tissue, the skeletal musculature, responsible for non-shivering (see below) and shivering thermogenesis, respectively, and the blood vessels that can influence temperature by changing their tone. Under vasoconstriction peripheral vessels in extremities reduce heat dissipation and thus contribute to rapid rise of the CBT.

These are important particular differences since hyperthermia, a condition in which the mechanisms of heat dissipation are not functional, and heat generation, in particular in skeletal muscle, occur and are often triggered by drugs, like succinylcholine, volatile anesthetics, methamphetamine, or cocaine. Similar to fever, it can be lethal, causing tachycardia (increased heart rate). It should be noted that the present treatments using dantrolene, a muscle relaxant,

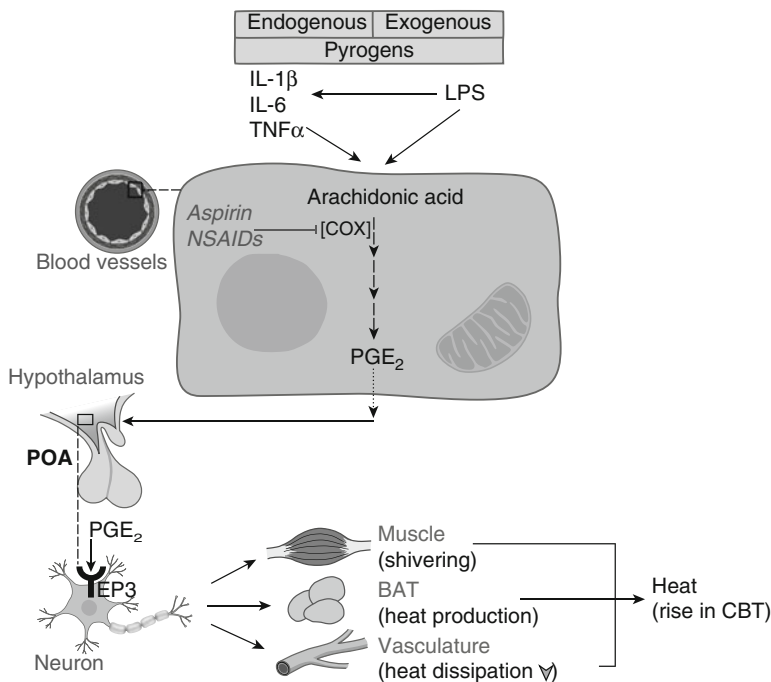

**Fig. 1** Schematic representation of the mechanisms involved in fever. Endogenous pyrogens, such as the pro-inflammatory cytokines interleukin 1 $\beta$  (IL-1 $\beta$ ), IL-6, and tumor necrosis factor  $\alpha$  (TNF $\alpha$ ) or exogenous pyrogens such as the bacterial cell wall component lipopolysaccharide (LPS), respectively, stimulate the cellular synthesis of the prostaglandin  $E_2$  ( $PGE_2$ ). This involves biochemical pathways in the brain vasculature or the periphery causing the peroxidation of arachidonic acid by cyclooxygenase (COX).

Importantly, antipyretic drugs including aspirin and other nonsteroidal anti-inflammatory drugs (NSAIDs) act by inhibiting COX activity. Released  $PGE_2$  then acts on neurons in the hypothalamic preoptic area (POA) carrying the prostaglandin E receptor 3 (EP3). These neurons activate production of heat primarily by activating a shivering reaction in skeletal muscles, heat production in the brown adipose tissue (BAT), and affecting heat dissipation by vasoconstriction in the periphery



have reduced malignant hyperthermia-associated mortality to around 5 %.

## Pyrogens

PGE<sub>2</sub> can be synthesized in response to external or internal signals (exogenous or endogenous pyrogens, respectively). Their ability to trigger PGE<sub>2</sub> production is the main reason fever is recognized as a sign of infection, as typically exogenous pyrogens are of microbial origin. The best-characterized one is a component of the bacterial cell wall termed lipopolysaccharide (LPS), but others like the yeast-derived zymogen are also potent exogenous pyrogens. Yet, fever can be also triggered by endogenous pyrogens released by damaged cells during inflammation. The cell types that synthesize and release endogenous pyrogens include cells of the immune system, such as macrophages, brain microglia, but also endothelial cells and other cell types of nonimmunologic origin. Thus, endogenous pyrogens can contribute to the fever response triggered by the stimulation of immune responses to infectious agents, such as viruses or fungi, which do not produce exogenous pyrogens (like bacteria do). Finally, endogenous pyrogens can also be released during pathological conditions that are not associated with infections. These can range from trauma causing tissue damage to more severe conditions including several types of cancer.

The first and best-characterized endogenous pyrogen is interleukin-1 $\beta$  (IL-1 $\beta$ ), but additional ones exist such as IL-6 and tumor necrosis factor  $\alpha$  (TNF $\alpha$ ). It is interesting to point out that IL-1 $\beta$  and TNF $\alpha$  can induce each other's synthesis and that both these proinflammatory cytokines stimulate the production of IL-6. In turn, they all trigger PGE<sub>2</sub> synthesis, thus converging to the same mechanism of fever induction used by the exogenous pyrogens.

## Anapyrexia: The Opposite of Fever

Although infections are typically associated with fever, severe systemic inflammation, as well as

sepsis, is accompanied by lowering of the CBT (see chapter “Sepsis”), a controlled hypothermic response referred to as anapyrexia [3]. Like fever, this hypothermia is also a centrally regulated response. Anapyrexia is probably mediated by prostaglandins and/or endocannabinoids, but the exact mechanisms remain to be fully elucidated. Anapyrexia is of great clinical significance, as hypothermic patients have a 46 % higher frequency of central nervous system dysfunction and are twice as likely to die of toxic shock [4].

## Metabolic Changes During Fever

Since the temperature elevation during fever is primarily due to an increase in thermogenesis, fever effectively dissipates a considerable amount of energy in the form of heat. The effects of these actions on metabolism can be broadly distinguished into an increase of energy expenditure and thermodynamic effects that elevated temperature can have on metabolic reactions. Both effects can vary greatly depending on the amplitude and the duration of the fever.

Typically, fever reaches its maximum within 60–90 min after its onset with a profile that can vary depending on the pathology to which it is associated and is often biphasic. Most often, the maximum value reached by fever is on average between 38 and 39 °C or 1–2 °C above normal. In these conditions, the thermodynamic effects of fever are considered to be minimal as the rate of chemical reaction requires an increase in temperature of 10 °C in order to double.

Instead, the metabolic cost of fever is often dramatic, i.e., metabolic heat production increases by 15–50 % to sustain a temperature increase of 1 °C. Factors affecting the variability include size, ambient temperature [5], and duration of fever [5, 6]. This may become clinically relevant even for smaller temperature changes especially if they are maintained for a longer period of time or if present recurrently. For instance, mild fever associated with cancer is an important component of cachexia, a wasting condition also characterized by muscular atrophy and appetite loss, which affects over 50 % of cancer patients and is



a major contributor to treatment failure and mortality [7–9]. Several endogenous pyrogens contribute to cachexia, including TNF $\alpha$  [10].

On an exactly opposite side, it is interesting to notice that recently the strategy to increase energy dissipation in the form of heat is being regarded as an attractive approach to treat obesity and the metabolic syndrome (see chapter “[Metabolic syndrome](#)”). This was recently spurred by the confirmation that adult humans retain active brown adipose tissue previously believed to be significant only in infants. This mitochondria-rich tissue specializes in thermogenesis by uncoupling of the mitochondria electron transport chain required for the production of ATP, via the activation of uncoupling protein 1 (UCP1). Several laboratories around the world are actively investigating the possibility of increasing the amount of brown adipose tissue or its activation for therapeutic purposes [11, 12].

---

## Introduction to Treatment and Influence on Metabolism

Adults with healthy cardiovascular and respiratory systems, who experience fever as a result of a bacterial infection (usually for a few days), can withstand it safely without antipyretic drugs. But even for these patients, the highly efficacious, over-the-counter available, cheap drugs have become routine use. Infants and small children, who can run very high fever, are almost always given antipyretics. Similarly, aged people are invariably treated because of suspected or manifest cardiovascular and respiratory weaknesses.

Antipyretic (fever-lowering) drugs have been available and used long before the mechanisms of fever and those of antipyretic drugs were understood. The most famous member of the class, which is also called nonsteroidal anti-inflammatory drugs (NSAIDs), is acetylsalicylic acid (aspirin), an inhibitor of cyclooxygenases (COXs, see below). Synthesis of PGE<sub>2</sub> requires the enzymatic peroxidation of arachidonic acid, a reaction catalyzed by COXs, and, as fever is ultimately mediated by PGE<sub>2</sub>, lowering their level represents an effective antipyretic strategy.

It is important to note that COXs do not participate uniquely in the synthesis of PGE<sub>2</sub>, but also of other prostaglandins and inflammatory mediators as well. At least two isoforms of cyclooxygenases exist, termed COX-1 and COX-2, which are constitutively or inducibly expressed, respectively, and present in different cells and tissues. These differences are important when considering the side effects of distinct COX inhibitors and explain the ongoing search for further antipyretics. For instance, aspirin irreversibly inhibits COX-1 by covalently linking to it, yet it also modifies the enzymatic activity of COX-2 [13]. Since inhibition of COX-1 also reduces the PGE<sub>2</sub>-dependent buffering activity that carbonate has on gastric acidity, prolonged inhibition of this enzyme can have gastric side effects leading to bleeding ulcers (see chapter “[Peptic ulcer disease](#)”). The most often used antipyretic drug today is ibuprofen, a nonselective COX inhibitor (that also belongs to the NSAIDs) that inhibits both COX-1 and COX-2. It is efficacious and safe, except for similar gastric side effects (as mentioned above). Selective COX-2 inhibitors (such as Vioxx, Celebrex, Bextra) without gastric side effects have been developed as arthritis drugs (see chapter “[Osteoarthritis](#)”), although they are also efficacious antipyretics. However, their use has been discouraged by adverse effects on the cardiovascular system, leading to myocardial infarctions. Finally, acetaminophen (paracetamol) is often used when aspirin and ibuprofen are ineffective.

COX inhibitors have also been tested in treating cachexia. It should, however, be mentioned that although fever is an important component of this wasting syndrome, other factors also contribute to it. With respect to this, an important approach is the attempt to normalize the levels of TNF $\alpha$ , which contribute to elevated temperature but can also damage tissues directly.

It should also be noted that hyperthermia does not respond to antipyretic drugs that act by resetting the thermostat. In fact, hyperthermia is commonly treated by direct cooling with cold water or ice to prevent excess heat from causing a circulatory collapse. Drug-induced hyperthermia is now treated with the muscle relaxant dantrolene.

## Perspectives

The role of fever is much debated, and the early assumption that fever “assists the immune system to defeat microbial infection” has not been proven. It is clear that fever remains our most reliable quantitative biomarker of ongoing infection.

Fever treatments are widely used as they are effective and cheap, and their side effect profile – mostly gastric sensitivity – is easily recognized. The use of the most common antipyretic drugs aspirin, ibuprofen, and acetaminophen (paracetamol) has over 50 years of clinical experience, and the doses are well known. Yet, efforts to produce safer anti-inflammatory/antipyretic drugs for chronic use continues. Finally, while fever and hyperthermia are well managed, chronic low-grade fever (as occurring in tuberculosis and cancer patients) and high fever peaks of malaria patients remain challenging.

## References

- Morrison SF, Nakamura K (2011) Central neural pathways for thermoregulation. *Front Biosci* 16:74–104
- Lazarus M, Yoshida K, Coppari R, Bass CE, Mochizuki T, Lowell BB, Saper CB (2007) EP3 prostaglandin receptors in the median preoptic nucleus are critical for fever responses. *Nat Neurosci* 10:1131–1133
- Steiner AA, Branco LG (2002) Hypoxia-induced anaptyrexia: implications and putative mediators. *Annu Rev Physiol* 64:263–288
- Clemmer TP, Fisher CJ Jr, Bone RC, Slotman GJ, Metz CA, Thomas FO (1992) Hypothermia in the sepsis syndrome and clinical outcome. The Methylprednisolone Severe Sepsis Study Group. *Crit Care Med* 20:1395–1401
- Baracos VE, Whitmore WT, Gale R (1987) The metabolic cost of fever. *Can J Physiol Pharmacol* 65:1248–1254
- Buskirk ER, Thompson RH, Rubenstein M, Wolff SM (1964) Heat exchange in men and women following intravenous injection of endotoxin. *J Appl Physiol* 19:907–913
- Argiles JM, Busquets S, Toledo M, Lopez-Soriano FJ (2009) The role of cytokines in cancer cachexia. *Curr Opin Support Palliat Care* 3:263–268
- Evans WJ, Morley JE, Argilés J, Bales C, Baracos V, Guttridge D, Jatoi A, Kalantar-Zadeh K, Lochs H, Mantovani G, Marks D, Mitch WE, Muscaritoli M, Najand A, Ponikowski P, Rossi Fanelli F, Schambelan M, Schols A, Schuster M, Thomas D, Wolfe R, Anker SD (2008) Cachexia: a new definition. *Clin Nutr* 27:793–799
- Kumar NB, Kazi A, Smith T, Crocker T, Yu D, Reich RR, Reddy K, Hastings S, Exterman M, Balducci L, Dalton K, Bepler G (2010) Cancer cachexia: traditional therapies and novel molecular mechanism-based approaches to treatment. *Curr Treat Options Oncol* 11:107–117
- Beutler B, Greenwald D, Hulmes JD, Chang M, Pan YC, Mathison J, Ulevitch R, Cerami A (1985) Identity of tumour necrosis factor and the macrophage-secreted factor cachectin. *Nature* 316:552–554
- Cannon B, Nedergaard J (2004) Brown adipose tissue: function and physiological significance. *Physiol Rev* 84:277–359
- Ginter E, Simko V (2012) Brown fat tissue – a potential target to combat obesity. *Bratisl Lek Listy* 113:52–56
- Roth GJ, Machuga ET, Ozols J (1983) Isolation and covalent structure of the aspirin-modified, active-site region of prostaglandin synthetase. *Biochemistry* 22:4672–4675

---

# Sepsis

Jean-Charles Preiser and Jean-Louis Vincent

---

## Introduction to Sepsis

Sepsis is a life-threatening pathogenic state characterized by whole-body inflammation triggered by an infection. The presence of an infection may be confirmed by the identification of pathogens in the bloodstream (mainly bacteremia or fungemia) and/or in other locations. The mortality attributable to sepsis is still high (30–50 %), in spite of major progress in the general management of intensive care patients.

The immune response to infection is a trigger of the “stress response,” which is mounted to survive any life-threatening injury and to restore homeostasis (constancy of the internal environment). This response is variable in its nature and intensity over time. A first, so-called ebb phase (by analogy to the backflow of the tide) immediately follows the onset of injury. This first phase is characterized by hypometabolism, clinically reflected by hypothermia and hypoperfusion of the extremities, and is associated with a reduction in energy expenditure. The second phase, called “flow phase,” is driven by the hormonal and inflammatory response to the initial injury. These mediators trigger an intense catabolism, leading to the breakdown of proteins and fat.

Clinically, this phase is typically characterized by high flow to the peripheral tissues (sometimes associated with hyperthermia). The third phase, usually termed “recovery phase,” is characterized by progressive return to normal physiology. However, even though progressive recovery of most organs and functions is observed during this phase, protein breakdown of muscle and splanchnic tissues (such as gut and liver) can still continue and will eventually lead to a major reduction in lean body mass, a devastating clinical consequence of sepsis.

---

## Pathophysiology of Sepsis and Metabolic Alterations

The body has developed a well-conserved, complex, and highly coordinated range of adaptive mechanisms to infection including major neuroendocrine and inflammatory components (Fig. 1). The development of insulin resistance is an important unifying response dedicated to providing substrates to vital tissues (such as brain and heart). Several components contribute to the development of this adaptive response.

## Neuroendocrine Component

The hypothalamus is the central component of the response to stress (see chapter “**Overview**” under part “Brain”). It coordinates the activity

---

J.-C. Preiser • J.-L. Vincent (✉)  
Department of Intensive Care,  
Erasmus Hospital, Université libre de Bruxelles,  
Route de Lennik 808, Brussels 1070, Belgium  
e-mail: [jean-charles.preiser@erasme.ulb.ac.be](mailto:jean-charles.preiser@erasme.ulb.ac.be);  
[jlvincen@ulb.ac.be](mailto:jlvincen@ulb.ac.be)

**Fig. 1** The main metabolic changes in sepsis. *ACTH* adrenocorticotrophic hormone, *GH* growth hormone, *TNF $\alpha$*  tumor necrosis factor  $\alpha$ , *IL* interleukin, *IGF* insulin-like growth factor

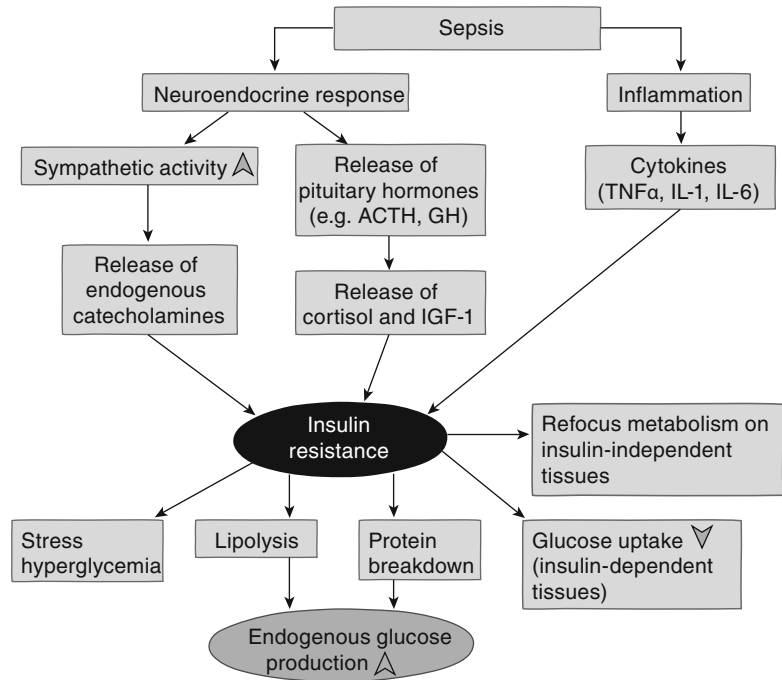

of the autonomic nervous system and the endocrine response to different stimuli, including decreased blood volume and arterial pressure or increased concentrations of inflammatory mediators. These stimuli ultimately increase sympathetic activity and induce an increased release of endogenous catecholamines from the adrenal medulla and from the sympathetic nervous system to restore homeostasis and allow proper function of the body. Hypothalamic hormones also stimulate the pituitary gland to produce adrenocorticotrophic hormone (ACTH) and growth hormone (GH). The rapid release of these pituitary hormones induces the release of cortisol by the adrenal cortex (see chapter “Major depressive disorder”) and insulin-like growth factor 1 by the liver. These changes result in salt and water retention, increased protein catabolism and lipolysis, and gluconeogenesis. Body temperature, a major metabolic regulator, is also increased via the hypothalamus (see chapter “Fever”). Of note, the hypothalamic regulation of body temperature can be impaired if the infection affects the brain (septic encephalopathy).

## Inflammatory Component

Although most of the effects of cytokines are designed to neutralize invading microorganisms, they can also impair some of the body’s physiological functions. For example, tumor necrosis factor  $\alpha$  (TNF $\alpha$ ), interleukin (IL)-1, and IL-6 play pivotal roles in the metabolic changes associated with sepsis. In addition to typical clinical signs of sepsis (fever, lethargy), these cytokines can also induce increased proteolysis and lipolysis, and later a loss of weight. In addition, anorexia is triggered at the hypothalamic level.

## Insulin Resistance and Stress Hyperglycemia

Increased insulin resistance is considered to be a typical adaptive change designed to survive a noxious stimulus [1] (such as sepsis) and can occur within a matter of minutes or hours. In fact, the magnitude of insulin resistance (reflected by the degree of hyperglycemia) is an index of the severity of sepsis [2].

During sepsis, inflammatory mediators (including cytokines such as TNF $\alpha$  and IL-1, released by activated immune cells to counteract the infection) and adipokines (such as leptin and resistin released from adipose tissue) induce and perpetuate insulin resistance and thus trigger hyperglycemia [3]. They act by reducing insulin receptor expression in peripheral tissues. Additionally, counter-regulatory hormones (cortisol, glucagon, and growth hormones), which are massively released during the early phase of sepsis, and increased sympathetic drive also contribute to hyperglycemia.

In addition to hyperglycemia, the consequences of insulin resistance include decreased uptake of glucose in insulin-dependent tissues (fat and muscle); increased glycogen breakdown and endogenous glucose production (gluconeogenesis) from lactate, glycerol, and alanine; increased lipolysis; and protein breakdown. Insulin resistance increases and prolongs the supply of glucose to tissues and cells essential for survival (such as brain, heart, immune cells, and erythrocytes), as these do not depend on insulin. For example, glucose is the only useable source of energy for red and white blood cells, including immune and inflammatory cells; the uptake of glucose in these cells is proportional to the surrounding glucose concentration. Thus, some degree of insulin resistance and hyperglycemia is adequate and beneficial.

Since adipocytes release glycerol, and skeletal muscle releases glucogenic amino acids, the liver can use these substrates to produce more glucose via gluconeogenesis.

Glucose is used as the primary fuel by the insulin-independent tissues during the first acute phase of sepsis.

## Changes in Body Composition

Following these metabolic adaptations is a change in body composition. The fat compartment decreases when sepsis is prolonged, reflecting the consumption of glycerol as a gluconeogenic substrate and of fatty acids as an alternative energy

substrate in the muscle. However, the composition and amount of nutrition provided can largely influence the size of the fat compartment, when *de novo* lipogenesis occurs in case of excessive caloric intake.

---

## Influence of Treatment on Metabolism and Consequences for Patients

The first aim is to remove the causative agent activating the stress response and causing sepsis. Generally, sepsis treatment includes early and appropriate antimicrobial agents and the eradication of abscesses or septic foci, e.g., via surgical measures.

As regards metabolism, there is no single specific treatment for the metabolic changes induced by sepsis. To avoid severe hyperglycemia, intravenous insulin is recommended, based on the deleterious long-term effects of elevated glucose concentrations on several cell types, including the immune cells [4]. A physiological level of blood glucose is recommended, and insulin is titrated to avoid hyperglycemia, hypoglycemia, and high glycemic variability [4]. On the other hand, prolonged resistance to insulin is probably detrimental, as it will result in muscle wasting. Hence, the use of therapies that increase the resistance to insulin, such as catecholamines and steroids, should be limited in duration and dose [5, 6]. Finally, some non-glycemic effects of insulin could also play a role in the improvement of outcome of patients with sepsis [7].

Nutritional support should provide an adequate, but not excessive, amount of calories and proteins, enteral if possible (to be more physiologic), but parenteral if necessary [8].

Physiological activity limits muscle wasting and long-term consequences of the metabolic alterations of sepsis, such as intensive care unit-acquired weakness [9]. The use of anabolic drugs may potentially limit the devastating consequences of prolonged catabolism, but risks associated with these drugs, such as increased insulin resistance, limit their usefulness.

## Perspectives

Metabolic homeostasis in health is the result of a complex and interrelated network of cellular and hormonal players with multiple interacting feedback loops. This system is severely disrupted during sepsis as part of the body's stress response, thus leading to excessive catabolism and ultimately a loss of lean body mass associated with considerable short- and long-term morbidity and mortality. Unfortunately, therapies are limited, and thus sepsis will continue to remain a life-threatening state within the next decade. Important questions concern the intensity of insulin treatment to optimize glucose control, the nutritional additives to give optimal metabolic support, and monitoring of metabolic changes in critically ill patients to individually adapt the treatment.

The metabolic response in sepsis is an interesting and exciting field of active research, and therapies targeted at regulating the response are likely to be developed in the near future with important benefits for patient outcomes.

## References

1. Soeters MR, Soeters PB (2012) The evolutionary benefit of insulin resistance. *Clin Nutr* 31:1002–1007
2. Leonidou L, Michalaki M, Leonardou A, Polyzogopoulou E, Fouka K, Gerolymos M, Leonardos P, Psirogiannis A, Kyriazopoulou V, Gogos CA (2008) Stress-induced hyperglycemia in patients with severe sepsis: a compromising factor for survival. *Am J Med Sci* 336:467–471
3. Hillenbrand A, Weiss M, Knippschild U, Knippschild U, Wolf AM, Huber-Lang M (2012) Sepsis-induced adipokine change with regard to insulin resistance. *Int J Inflamm*. doi:10.1155/2012/972368
4. Dellinger RP, Levy MM, Rhodes A, Rhodes A, Annane D, Gerlach H, Opal SM, Sevransky JE, Sprung CL, Douglas IS, Jaeschke R, Osborn TM, Nunnally ME, Townsend SR, Reinhart K, Kleinpell RM, Angus DC, Deutschman CS, Machado FR, Rubenfeld GD, Webb SA, Beale RJ, Vincent JL, Moreno R (2013) Surviving sepsis campaign: international guidelines for management of severe sepsis and septic shock: 2012. *Crit Care Med* 41:580–637
5. Ichai C, Preiser JC (2010) International recommendations for glucose control in adult non diabetic critically ill patients. *Crit Care* 14:R166
6. Lena D, Kalfon P, Preiser JC et al (2011) Glycemic control in the intensive care unit and during the post-operative period. *Anesthesiology* 114:438–444
7. Vincent JL (2007) Metabolic support in sepsis and multiple organ failure: more questions than answers. *Crit Care Med* 35:S436–S440
8. Vincent JL, Preiser JC (2013) When should we add parenteral to enteral nutrition? *Lancet* 381:354–355
9. Schweickert WD, Pohlman MC, Pohlman AS et al (2009) Early physical and occupational therapy in mechanically ventilated, critically ill patients: a randomised controlled trial. *Lancet* 373:1874–1882

---

# Allergies

Norbert Meyer and James Yun

---

## Introduction to Allergies

During an allergic reaction, the immune system reacts to normally harmless foreign substances such as pollen, medications, food, or animal dander. Although allergic reactions can principally take place in all organs, the primary target organs are the skin, respiratory system, gastrointestinal tract, and eyes. Depending on the organs involved, symptoms of allergic reactions include nasal congestion, eczema, pruritus, cough, chest tightness, wheezing, dyspnea, and vomiting. In case of anaphylaxis, a potentially fatal severe allergic reaction, cardiovascular changes resulting in hypotension and tachycardia can additionally occur. Allergic diseases are characterized by immune responses predominantly driven by T-helper-2 ( $T_H2$ ) cells, which activate many immune cells to produce and release different inflammatory mediators during an allergic reaction (see chapter “[Overview](#)” under the part “Immune system”). Apart from allergen avoidance, the treatment principles are neutralization of these mediators particularly in the short term and restoration of immune balance between  $T_H2$  cells and other lymphocyte subsets like T-helper-1 ( $T_H1$ ) or regulatory T ( $T_{reg}$ ) cells

in the long term. The risk factors include family history of allergy/genetic factors and environmental factors such as exposures to allergens and microbes. However, a number of studies show conflicting data for the latter, suggesting that the interaction of certain allergens and infectious agents with the immune system is complicated. Nonetheless, a dramatic increase in allergic diseases in industrialized countries over the last several decades implicates environmental factors as a major contributor. Allergic diseases affect up to 30 % of the population in these countries, resulting in high economical burden of the diseases.

---

## Pathophysiology of Allergies and Metabolic Alterations

The immune mechanisms underlying allergic diseases could be summarized into two main phases, the sensitization phase and the effector phase (Fig. 1). The sensitization phase takes place when an individual is exposed to the allergen for the first time. Protein antigens are first processed into peptides for presentation on major histocompatibility complex (MHC) molecules on the surface of antigen-presenting cells, most importantly dendritic cells (DCs), to induce an immune or allergic response (see chapter “[Overview](#)” under the part “Immune system”). DCs are present in an epithelial cell layer, e.g., in the skin or lung [1].

When allergens enter the body, they have to cross the epithelial cell layer. During this step, they can activate receptors of the innate immune

---

N. Meyer (✉) • J. Yun  
Division of Allergology,  
Clinic for Rheumatology and Clinical Immunology/  
Allergology, University of Bern,  
Bern CH-3010, Switzerland  
e-mail: [norbert.meyer@insel.ch](mailto:norbert.meyer@insel.ch);  
[james.j.yun@gmail.com](mailto:james.j.yun@gmail.com)



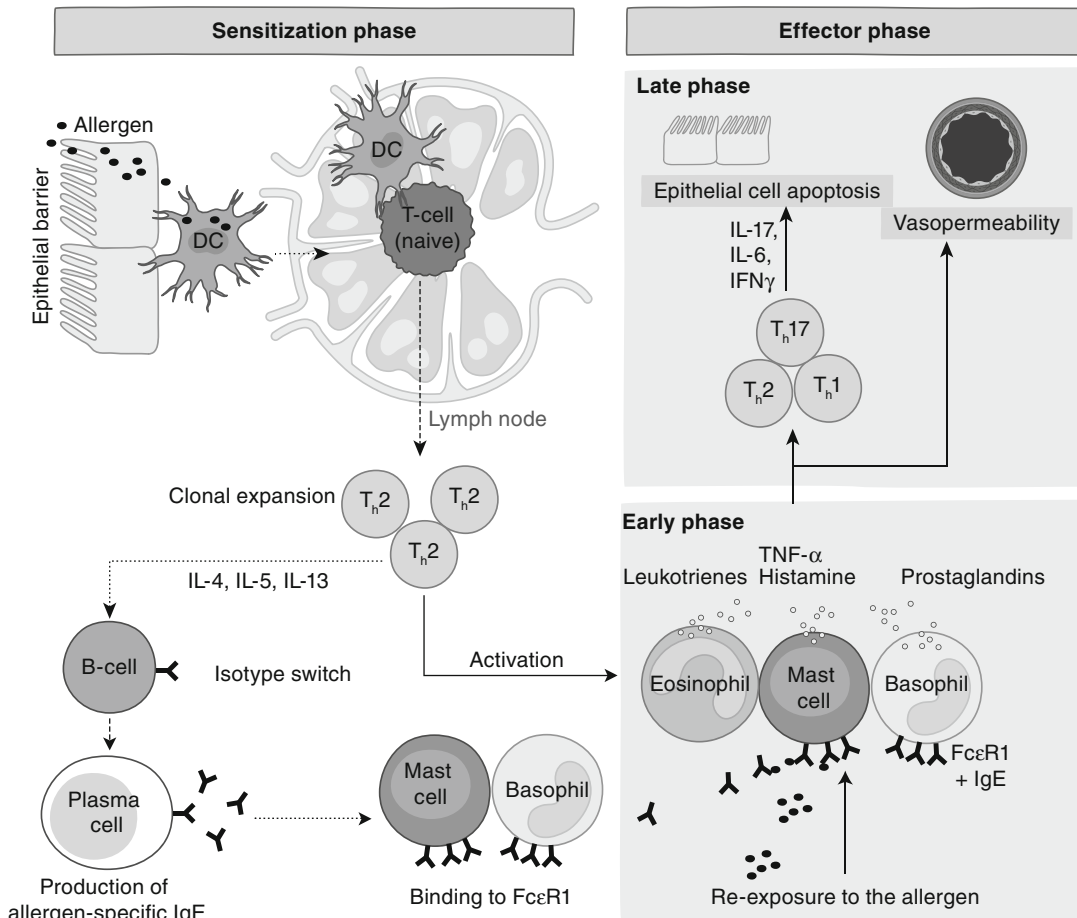

**Fig. 1** Overview of a typical allergic reaction. The sensitization phase (*left*) leads to the generation of allergen-specific  $T_H2$  cells, which induce the production of allergen-specific immunoglobulin E (IgE) by B cells. Reexposure to the allergen initiates the effector phase (*right*) and causes cross-linking of the IgE-FcεR1 complexes on sensitized basophils and mast cells, which activates them. This activation causes release of various pro-inflammatory cytokines and chemokines, most notably histamine, tumor necrosis factor  $\alpha$  (TNF $\alpha$ ),

prostaglandins, and leukotrienes initiating the early reactions of the effector phase. After a few hours, during the late-phase reaction, T helper cells, such as  $T_H2$ -,  $T_H1$ -, and  $T_H17$  cells, recruited from the circulation, enhance the local tissue inflammation causing continued inflammation, epithelial apoptosis, and vasopermeability. DC dendritic cell, IL interleukin, IFN interferon. Note that the cells are displayed in higher magnification compared to the lymph node

system, such as Toll-like receptors, on epithelial cells, which subsequently release several cytokines affecting DCs [2]. For example, epithelial cells secrete thymic stromal lymphopoietin or interleukin-25 (IL-25), which activates DCs to secrete cytokines that induce and enhance  $T_H2$  responses. After the allergen is taken up, processed, and presented by DCs, these move to the regional lymph nodes, where naive CD4-positive (CD4<sup>+</sup>) T lymphocytes recognize the presented

peptides (see chapter “Overview” under the part “Immune system”). Naive T cells did not have any contact with antigens before. In the lymph nodes, DCs secrete cytokines like IL-4, which induce differentiation from naive T cells into  $T_H2$  cells. This is followed by the selective expansion of allergen-specific  $T_H2$  cells that secrete mainly IL-4, IL-5, IL-9, IL-13, and granulocyte macrophage colony-stimulating factor (GM-CSF), in order to increase the activity of several immune

cells (e.g., mast cells, basophils, B cells) during the allergic inflammation.  $T_H2$  cells then travel to the initial site of allergen exposure. In the periphery, a wide range of antigen-specific B cells is normally present and produces immunoglobulin (Ig) M and D antibodies. When these B cells are activated by IL-4 and IL-13 released by  $T_H2$  cells, they undergo “isotype switching” to produce mainly allergen-specific immunoglobulin E (IgE) rather than other immunoglobulin isotypes [3]. The secreted allergen-specific IgEs then bind to the high-affinity IgE receptor (FcεRI) expressed on the surface of mast cells and basophils, leading to sensitization.

Reexposure with the allergen triggers the effector phase of allergy, which could be divided into an early and late phase. Re-exposure causes cross-linking of the IgE-FcεRI complexes on sensitized basophils and mast cells and triggers their activation and subsequent rapid release of mediators like histamine, leukotrienes, prostaglandins, cytokines, chemokines, and growth factors, a response also known as degranulation. Histamine derived from the amino acid histidine through decarboxylation is one of the major inflammatory mediators during the effector phase. After binding to histamine receptor, it activates phospholipase C and the phosphatidylinositol pathway and causes vasodilatation, pruritus, bronchoconstriction, tachycardia, and flushing, symptoms characteristic of allergies. While there are four types of histamine receptors, predominantly  $H_1$  receptors, and to lesser extent  $H_2$  receptors, are responsible for these actions.  $H_1$  receptors are abundantly expressed throughout the body, but receptor activation in smooth muscle and vascular endothelial cells is mainly responsible for these symptoms [4].

Another class of inflammatory mediators, the leukotrienes, is derived from arachidonic acid. There are two types of leukotrienes: the dihydroxy acid leukotrienes, predominantly produced by neutrophils, and the cysteinyl leukotrienes, mainly secreted by activated eosinophils, mast cells, and basophils [3]. Cytokines released by  $T_H2$  cells enhance eosinophil recruitment to the tissues and trigger release of leukotrienes. Cysteinyl leukotrienes bind to leukotriene

receptor 1 and 2, the first of which has important functions during the induction of allergic inflammation in the lung or skin.

During the early effector phase, adhesion molecules appear on the surface of endothelial cells to recruit inflammatory cells like lymphocytes and eosinophils, which enhance the allergic reaction after 4–12 h (late effector phase).  $T_H2$  cells are still present during the effector phase and release cytokines to enhance the function of immune cells implicated in the effector phase. For example, IL-9 and IL-13 increase mast cell growth, and IL-3 and GM-CSF enhance eosinophil maturation and survival and basophil recruitment [3]. In addition,  $T_H2$  cytokines also play a key role in mucus production and smooth muscle contraction in the airways during allergic asthma (see chapter “Asthma”). Continuous presence of allergens results in chronic and more severe allergic inflammation (the late phase of allergies), which is characterized by the activation of other effector T-cell subsets like  $T_H17$ - and  $T_H1$  cells, which further contribute to the allergic inflammation [5].  $T_H1$  cells secrete interferon- $\gamma$  which induces apoptosis of epithelial cells in the lung, nose, or skin exacerbating the effector phase.  $T_H17$  cells secrete IL-17, which enhances the secretion of pro-inflammatory cytokines like IL-6 by epithelial cells. Basophils, mast cells, and eosinophils also play a role during the late-phase reaction. They secrete factors, which enhance local tissue inflammation, vasopermeability, and attraction of other inflammatory immune cells.

Upon allergen exposure, some individuals may experience anaphylaxis due to sudden release of mediators from mast cells and basophils. A number of mediators including histamine, tryptase, platelet-activating factor, and leukotrienes as well as complement and coagulation pathways are involved. When these mediators are released in large quantity, they can cause sudden changes in the cardiovascular and respiratory system resulting in hypotension, tachycardia, hypovolemia due to increased vascular permeability, bronchospasm, and angioedema of upper airways. Anaphylaxis requires urgent attention and can be fatal if left untreated.

## Treatment of Allergies

The primary treatment for an established allergy is avoidance of the allergen. However, this is often difficult for aeroallergens and troublesome for food and medications where accidental re-exposure is not uncommon. The principles of pharmacotherapy of allergic diseases comprise medications suppressing the allergic inflammation, either by suppressing inflammatory cells directly or by blocking the released mediators. In case of anaphylaxis, the most important treatment is the immediate administration of epinephrine, which has  $\alpha 1$  adrenergic vasoconstrictor effects on small arterioles and can therefore increase the blood pressure to ensure sufficient blood circulation.

Glucocorticoids are the most important anti-inflammatory drugs, but they have many adverse effects caused by their mineralocorticoid effects and multiple targets. Neutralization of the mediators such as histamine and leukotriene has fewer side effects but is often less effective and transient, as other mediators are also important. The only potentially curative and antigen-specific treatment of allergic diseases is allergen-specific immunotherapy. It aims to trigger endogenous mechanisms to suppress immune reactions, in this case the allergic reaction, by administration of low doses of allergen and gradually building up immune tolerance by increasing the dose. It often takes years of repeated administration.

---

### Influence of Treatment on Metabolism and Consequences for Patients

Glucocorticoids are effective drugs suppressing allergic diseases, including those of the gastrointestinal tract, eye, skin, lung, and nose. Glucocorticoids signal via classical intracellular receptors (similar to steroid hormones, see chapter “[Overview](#)” under the part “Reproductive system”). Upon binding, cytoplasmic glucocorticoid receptors translocate to the nucleus, bind to glucocorticoid response elements triggering expression of anti-inflammatory genes (such as

lipomodulin, IL-10, I $\kappa$ B), and block transcription of pro-inflammatory genes, such as activating protein 1 or nuclear factor (NF)- $\kappa$ B. In addition, glucocorticoids show mineralocorticoid and other glucocorticoid-related effects including altered protein and glucose metabolism and fat lipolysis. This results in many undesirable adverse effects like osteoporosis (see chapter “[Osteoporosis](#)”), adrenal insufficiency, or muscle mass reduction, especially during systemic treatment [6].

Antihistamines are effective drugs for allergic diseases as they neutralize histamine effects by blocking the histamine receptors H<sub>1</sub> and H<sub>2</sub>. Whereas the H<sub>2</sub> receptor is involved in gastric acid secretion, stimulation of H<sub>1</sub> receptors is responsible for the majority of the symptoms during the early effector phase of an allergic reaction (see above). While H<sub>1</sub> antihistamines have excellent safety profile, their main side effects include sedation and anticholinergic effects, which are particularly pronounced in the first-generation antihistamines [7]. Their efficiency is limited, as they do not address the underlying cause and the cells that release histamine.

Drugs such as montelukast that inhibit the action of leukotrienes by blocking cysteinyl leukotriene receptor 1 are also used in the treatment of allergic rhinitis and allergic asthma (see chapter “[Asthma](#)”). Cromolyn sodium and nedocromil sodium inhibit Na-K-Cl cotransporters, which are involved in mast cell activation. These drugs are also known as mast cell stabilizers and used for the treatment of allergic rhinitis and conjunctivitis.

During allergen-specific immunotherapy, the administration of increasing doses of an allergen leads to a diminished allergic response upon re-exposure to the allergen. The most important underlying mechanism is the induction of T<sub>reg</sub> cells, which control and modify the development of allergic diseases by altering the sensitization and effector phase [8]. T<sub>reg</sub> cells secrete the immunosuppressive IL-10, which inhibits the activation of T<sub>H2</sub> cells (causing peripheral T-cell tolerance), mast cells, basophils, and eosinophils (Fig. 2a). In addition, IL-10 secreted by T<sub>reg</sub> cells induces IgG4 whose physiological function is poorly understood. Nonetheless, allergen-specific IgG4 competes with

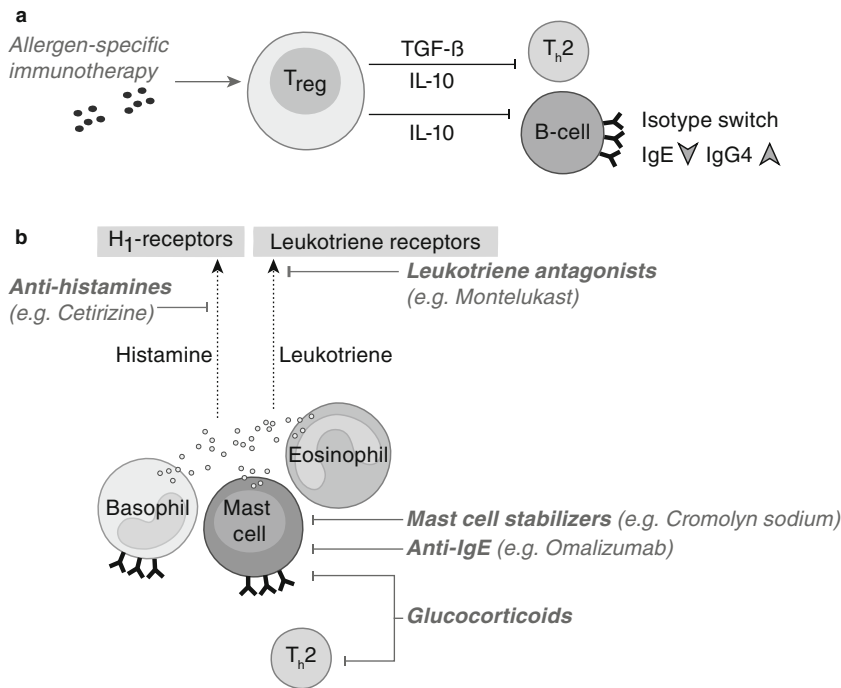

**Fig. 2** Overview of the mode of action of allergic disease treatments. **(a)** During allergen-specific immunotherapy,  $T_{reg}$  cells are induced by small, increasing amounts of the allergen.  $T_{reg}$  cells secrete interleukin-10 (IL-10), which shows a direct suppressive effect on  $T_{h2}$  cells, reduces immunoglobulin E (IgE) secretion, induces IgG4 secretion in B cells (their most important effect), and inhibits other inflammatory cells during allergic reaction.  $TGF-\beta$

transforming growth factor  $\beta$ . **(b)** Several drugs exist to block the mediators released during allergic inflammation or for suppression of inflammatory cells. Glucocorticoids show a broad spectrum of inhibitory potential (but also most severe side effects). Antihistamines, mast cell stabilizers, anti-IgE antibodies, and leukotriene antagonists inhibit specific mediators released or their signaling during allergic reactions but are also less effective

allergens for binding to the IgE on Fc $\epsilon$ RI of mast cells and basophils and thus acts as a blocking antibody that decreases IgE-mediated degranulation of mast cells and basophils [9].

Finally, other strategies for the treatment of allergic reactions include injection of humanized anti-IgE antibodies like omalizumab, which binds to free IgE at the sites used to attach to Fc $\epsilon$ RI. As it cannot cross-link IgE bound to its receptor, it only inhibits the binding of IgE to Fc $\epsilon$ RI on mast cells and basophils (Fig. 2b) [10].

In case of anaphylaxis, the most important treatment is epinephrine to immediately reverse vasodilatation and bronchospasm. As anaphylaxis is a potentially life-threatening condition, its administration should not be delayed. When a patient is considered at risk of anaphylaxis, an

epinephrine auto-injector should be handed to the patient with careful instruction on how and when to use it.

## Perspectives

One of the main tasks in the future is the development of treatment strategies inhibiting specific cytokines responsible for the allergic reaction. For example, blocking of  $T_{h2}$  cytokines could provide an effective therapeutic option for allergic diseases with fewer adverse effects compared to glucocorticoids. Currently, antibodies antagonizing the action of  $T_{h2}$  cytokines are tested in clinical trials but have not yet been approved as drugs for allergic diseases. Finally, better understanding

of the events involved in the sensitization of allergens will be important in preventing the development of allergic diseases in the first place.

## References

1. Hammad H, Lambrecht BN (2008) Dendritic cells and epithelial cells: linking innate and adaptive immunity in asthma. *Nat Rev Immunol* 8:193–204
2. Lambrecht BN, Hammad H (2012) The airway epithelium in asthma. *Nat Med* 18:684–692
3. Stone KD, Prussn C, Metcalfe DD (2010) IgE, mast cells, basophils, and eosinophils. *J Allergy Clin Immunol* 125:S73–S80
4. Ferstl R, Akdis CA, O'Mahony L (2012) Histamine regulation of innate and adaptive immunity. *Front Biosci (Landmark Ed)* 17:40–53
5. Bousquet J, Anto JM, Demoly P, Schünemann HJ, Togias A, Akdis M, Auffray C, Bachert C, Bieber T, Bousquet PJ, Carlsen KH, Casale TB, Cruz AA, Keil T, Lodrup Carlsen KC, Maurer M, Ohta K, Papadopoulos NG, Roman Rodriguez M, Samolinski B, Agache I, Andrianarisoa A, Ang CS, Annesi-Maesano I, Ballester F, Baena-Cagnani CE, Basagaña X, Bateman ED, Bel EH, Bedbrook A, Beghé B, Beji M, Ben Kheder A, Benet M, Bennoor KS, Bergmann KC, Berrissoul F, Bindslev Jensen C, Bleecker ER, Bonini S, Boner AL, Boulet LP, Brightling CE, Brozek JL, Bush A, Busse WW, Camargos PA, Canonica GW, Carr W, Cesario A, Chen YZ, Chiriac AM, Costa DJ, Cox L, Custovic A, Dahl R, Darsow U, Didi T, Dolen WK, Douagui H, Dubakienė R, El-Meziane A, Fonseca JA, Fokkens WJ, Fthenou E, Gamkrelidze A, Garcia-Aymerich J, Gerth van Wijk R, Gimeno-Santos E, Guerra S, Haahntela T, Haddad H, Hellings PW, Hellquist-Dahl B, Hohmann C, Howarth P, Hourihane JO, Humbert M, Jacquemin B, Just J, Kalayci O, Kaliner MA, Kauffmann F, Kerkhof M, Khayat G, Koffi N'Goran B, Kogevinas M, Koppelman GH, Kowalski ML, Kull I, Kuna P, Larenas D, Lavi I, Le LT, Lieberman P, Lipworth B, Mahboub B, Makela MJ, Martin F, Martinez FD, Marshall GD, Mazon A, Melen E, Meltzer EO, Mihaltan F, Mohammad Y, Mohammadi A, Momas I, Morais-Almeida M, Mullol J, Muraro A, Naclerio R, Nafti S, Namazova-Baranova L, Nawijn MC, Nyembue TD, Oddie S, O'Hehir RE, Okamoto Y, Orru MP, Ozdemir C, Ouedraogo GS, Palkonen S, Panzner P, Passalacqua G, Pawankar R, Pigearias B, Pin I, Pinart M, Pison C, Popov TA, Porta D, Postma DS, Price D, Rabe KF, Ratomaharo J, Reitamo S, Rezagui D, Ring J, Roberts R, Roca J, Rogala B, Romano A, Rosado-Pinto J, Ryan D, Sanchez-Borges M, Scadding GK, Sheikh A, Simons FE, Siroux V, Schmid-Grendelmeier PD, Smit HA, Sooronbaev T, Stein RT, Sterk PJ, Sunyer J, Terreehorst I, Toskala E, Tremblay Y, Valenta R, Valeyre D, Vandenplas O, van Weel C, Vassilaki M, Varraso R, Viegi G, Wang DY, Wickman M, Williams D, Wöhrl S, Wright J, Yorgancioglu A, Yusuf OM, Zar HJ, Zernotti ME, Zidam M, Zhong N, Zuberbier T (2012) Severe chronic allergic (and related) diseases: a uniform approach—a MeDALL–GA2LEN–ARIA position paper. *Int Arch Allergy Immunol* 158:216–231
6. Coutinho AE, Chapman KE (2011) The anti-inflammatory and immunosuppressive effects of glucocorticoids, recent developments and mechanistic insights. *Mol Cell Endocrinol* 335:2–13
7. Simons FE (2003) H1-Antihistamines: more relevant than ever in the treatment of allergic disorders. *J Allergy Clin Immunol* 112:S42–S52
8. Akdis CA (2012) Therapies for allergic inflammation: refining strategies to induce tolerance. *Nat Med* 18:736–749
9. Flicker S, Valenta R (2003) Renaissance of the blocking antibody concept in type I allergy. *Int Arch Allergy Immunol* 132:13–24
10. Beck LA, Marcotte GV, MacGlashan D, Togias A, Saini S (2004) Omalizumab-induced reductions in mast cell FcεR1 expression and function. *J Allergy Clin Immunol* 114:527–530

---

**Part XIV**

**Kidney**

---

## Overview

Markus M. Rinschen, Linus A. Völker,  
and Paul T. Brinkkötter

---

### Anatomy and Physiology of the Kidneys

The two human kidneys are localized in the retroperitoneal space of the abdomen. The adult size is approximately 11 × 6 × 4 cm. Anatomically, the kidney can be subdivided into three segments, the cortex, medulla, and pelvis (Fig. 1a). The latter gives rise to the ureter, which exits the kidney at the hilum.

Each kidney harbors approx. one million nephrons, its functional units, which are composed of glomeruli and tubules (Fig. 1b, c). The glomeruli are located in the renal cortex and are perfused by 4,000–5,000 l/day of blood. The glomerulus contains a capillary bed in which the primary urine is filtered into the tubules. The three-layered filter consists of the fenestrated vascular endothelial cells (see chapter “Overview” under the part “Blood vessels”), the glomerular basement membrane, and visceral epithelial cells, the podocytes, located at the outer aspect of the capillary loops (Fig. 1c, d). The latter form specific foot processes with a 40 nm gap in between neighboring foot processes bridged by a specialized cell-cell contact, the slit diaphragm [1]. Plasma and plasma proteins

are filtered based on their charge and molecular size (approx. <70 kDa) resulting in almost protein-free primary urine. The normal glomerular filtration rate (GFR) ranges from 130 to 180 l/day. The primary urine is then collected in Bowman’s capsule and further transported via the proximal tubule followed by the loop of Henle into the medulla where it makes a hairpin turn and ascends back into the cortex before it enters the distal tubule and the connecting tubule into the collecting duct.

A prominent brush border at the apical, lumen-oriented plasma membrane of epithelial cells characterizes the proximal tubule (Fig. 1b, c, e). The loop of Henle consists of a thin descending followed by a thin and subsequently thick ascending part (Fig. 1b, f). The distal convoluted tubule shows a similar structure as the proximal tubule; however, it lacks its prominent brush border. At the macula densa of the distal tubule (Fig. 1b, g), the nephron passes its own glomerulus at very close proximity (Fig. 1b, c). Several connecting tubules finally enter one of the collecting ducts (Fig. 1b, h), which transport the urine through the entire medulla and release it into the pelvis. Along the nephrons, the primary urine is concentrated to 1–3 l/day of terminal urine.

The blood flow of the kidney is maintained via the renal artery and renal vein. Continuous blood supply is of utmost importance to maintain high-capacity, energy-consuming transport processes (Fig. 1e–h) and other biological functions of the entire kidney epithelium. The renal artery enters the kidney at the hilum and divides into main segment arterial branches and subsequently into

---

M.M. Rinschen (✉) • L.A. Völker • P.T. Brinkkötter  
Department II of Internal Medicine and Center for  
Molecular Medicine Cologne (CMMC), University of  
Cologne, Kerpener Str. 62, Cologne DE-50937,  
Germany  
e-mail: [markus.rinschen@uk-koeln.de](mailto:markus.rinschen@uk-koeln.de);  
[linus.voelker@uk-koeln.de](mailto:linus.voelker@uk-koeln.de);  
[paul.brinkkoetter@uk-koeln.de](mailto:paul.brinkkoetter@uk-koeln.de)

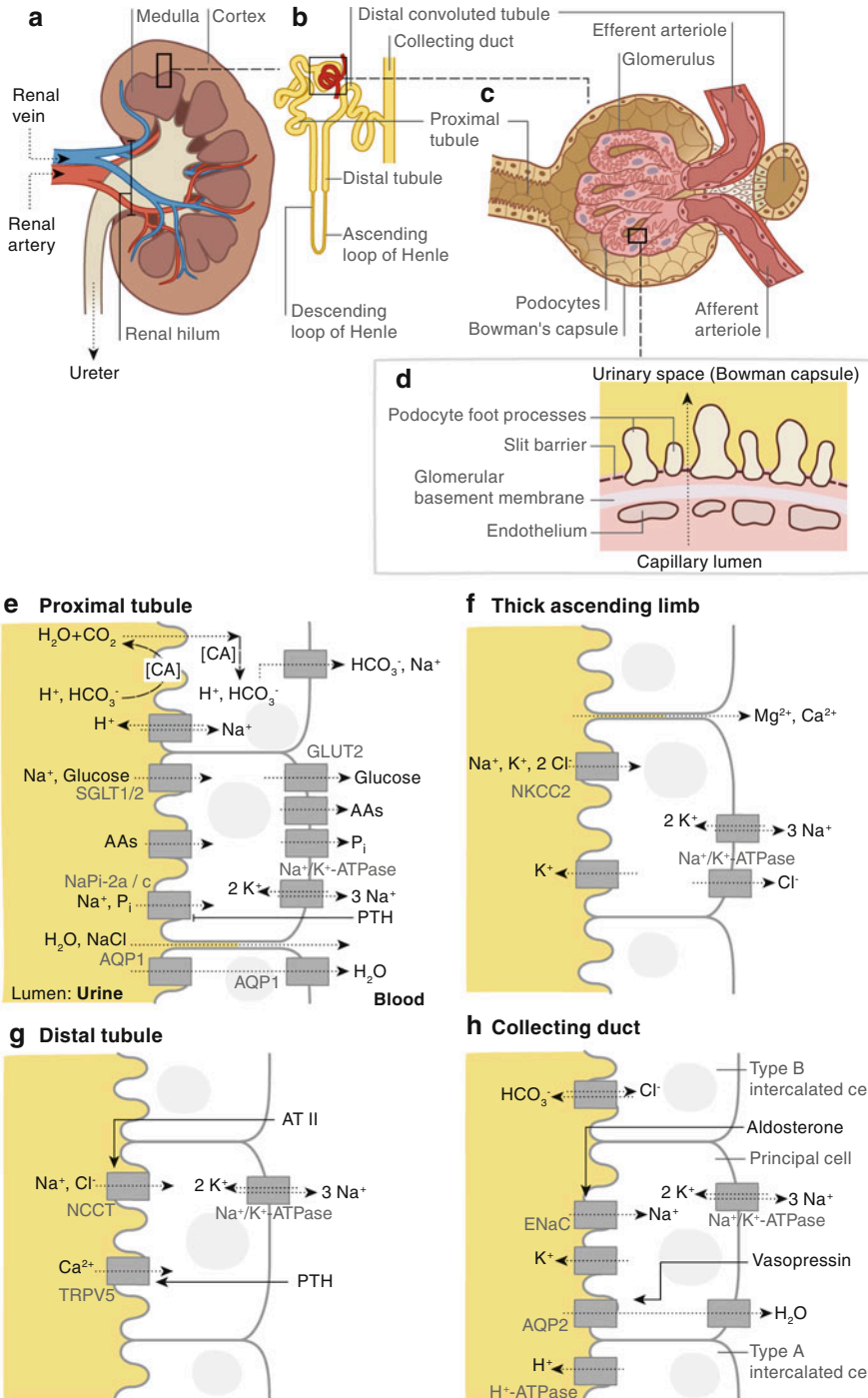



**Fig. 1** Anatomy and basic physiology of renal reabsorption and secretion. **(a)** Cross section through a kidney revealing renal artery and vein and the ureter emerging from the renal hilum. Each kidney contains around one million nephrons each oriented with their glomeruli toward the renal cortex and descending toward the medulla. **(b)** The nephron is the functional unit of the kidney, consisting of glomerulus and tubular system (proximal tubule, descending and ascending loop of Henle, distal tubule, and collecting duct). Blood vessels (not shown) supply the glomerulus and also the parts closer to the renal medulla (vasa recta). **(c)** Ultrastructure of the glomerulus. The kidney filtration barrier consists of endothelial cells, the glomerular basement membrane, and slit diaphragms spanning between podocyte foot processes. The glomerulus is surrounded by Bowman's capsule collecting the filtrate and directing it toward the proximal tubules. The distal convoluted tubule, a part of the distal tubules, sends feedback to the glomerulus. **(d)** The filtration barrier consists of fenestrated endothelium, glomerular basement membrane, and foot processes of surrounding podocytes containing a slit diaphragm. **(e–h)** Detailed views of key transport processes in the nephron from the luminal side (*yellow background*) to the blood (*white background*). **(e)** Transport processes in the proximal tubule include trans- and paracellular water uptake, bicarbonate reabsorption, and sugar and amino acid (AA) reabsorption. The latter are mostly driven by secondary gradients of  $\text{Na}^+$  built up by basolateral  $\text{Na}^+/\text{K}^+$ -ATPase. For reabsorption of glucose, sodium-glucose linked

transporters (*SGLT 1/2*) and glucose transporter 2 (*GLUT*) are necessary (see chapter “*Diabetes mellitus*”). If bicarbonate reabsorption is necessary, it occurs via  $\text{CO}_2$ , formed and disposed of by carbonic anhydrase (*CA*). Parathyroid hormone (PTH; see chapter “*Overview*” under the part “*Teeth and bones*”) is able to downregulate phosphate ( $P_i$ ) reuptake. **(f)** In the thick ascending limb of Henle, urine is concentrated by massive resorption of ions.  $\text{Mg}^{2+}$  and  $\text{Ca}^{2+}$  are absorbed mainly paracellularly.  $\text{Na}^+$  and  $\text{K}^+$  are reabsorbed via the Na-K-Cl cotransporter (*NKCC2*), a transporter driven by the sodium gradient. **(g)** In the distal tubule,  $\text{Na}^+$  and  $\text{K}^+$  are further reabsorbed, and  $\text{Ca}^{2+}$  reabsorption can be upregulated by PTH. Angiotensin II (AT II; see chapters “*Hypertension*” and “*Chronic kidney disease*”) can directly increase sodium reabsorption and subsequent water retention by activating the sodium-chloride symporter, also known as  $\text{Na}^+/\text{Cl}^-$  cotransporter (*NCCT*). **(h)** The collecting duct consists of two major cell types, i.e. principal cells responsible for water and urea reabsorption and intercalated cells responsible for acid-base homeostasis. Sodium and water resorption can be upregulated by aldosterone (see chapters “*Hypertension*” and “*Chronic kidney disease*”) and vasopressin (see chapters “*Overview*” under the part “*Brain*” and “*Cirrhosis*”), respectively. Names of transporters and channels not specifically mentioned in the text or not regulated by signals mentioned in the book where omitted due to space constraints. *AQP* aquaporin, *TRPV5* transient receptor potential cation channel subfamily V member 5, *ENaC* epithelial  $\text{Na}^+$  channel

interlobular arteries and afferent arterioles to the glomerulus as well as the vasa recta for the blood support of the inner medulla (Fig. 1a, c).

The kidney participates in the body homeostasis to maintain a relatively constant extracellular environment. Among its specific functions are (1) regulation of water and electrolyte metabolism, (2) regulation of acid-base homeostasis, (3) detoxification and excretion of waste products, (4) reabsorption of glucose and other essential metabolites, (5) endocrine function, and (6) synthesis of glucose under fasting conditions.

## Kidney-Specific Metabolic and Molecular Pathways and Processes

The GFR equals the sum of the filtration rates of all nephrons and is defined as the freely filtered plasma volume per time. It can be measured as inulin or creatinine clearance or estimated apply-

ing mathematical algorithms, e.g. CKD-EPI 2009/2012 formulas. The clearance refers to the plasma volume, which is cleared from these substances within a given time. Its calculation requires the measurement of urine concentration of creatinine, serum concentration of creatinine, and urine volume within a given time (usually 24 h).

The filtration fraction is strictly regulated by filtration pressure. This pressure depends on the hydrostatic pressure, which is dependent on the resistance of the afferent and efferent arteriole, and the oncotic pressure built up by the plasma protein concentration.

The main task of the kidney is to control water and electrolyte metabolism, to save and reabsorb several essential metabolites from the primary urine, and to excrete toxic metabolites. These processes occur in a segment-specific manner. The kidney tubular function largely depends on the unique distribution of transporters, channels, and pumps in various leaky or tight subsegments. The entire

kidney tubule has a polarized epithelium with unique distribution of transport proteins between the cell surfaces at the apical urinary space and the basolateral blood side. The  $\text{Na}^+/\text{K}^+$ -ATPase as a main pump sits on the basolateral side of the nephron and commonly serves as the driving force for direct or indirect electrolyte transport processes [2].

The proximal tubule is the main segment for  $\text{Na}^+$ , bicarbonate ( $\text{HCO}_3^-$ ), and water reabsorption (Fig. 1e).  $\text{Na}^+$  is mainly reabsorbed via several cotransporters. Importantly, under physiological conditions, the proximal tubule reabsorbs all of the filtered glucose (via the apically localized sodium-glucose linked transporters SGLT1 and SGLT2) as well as all amino acids [3]. The capacity for glucose reabsorption by the proximal tubule is approximately 200 mg/dl.

Water is transported both transcellularly via the water channel aquaporin 1 (AQP 1) as well as paracellularly via leaky cell-cell contacts.

The brush border of the proximal tubule contains the enzyme carboanhydrase, which catalyzes the conversion of carbonic acid ( $\text{H}_2\text{CO}_3$ ) to water ( $\text{H}_2\text{O}$ ) and carbon dioxide ( $\text{CO}_2$ ), which can diffuse freely through the epithelial cell membrane.  $\text{CO}_2$  is converted back to  $\text{HCO}_3^-$  by carboanhydrase expressed in the proximal tubule cells. These processes facilitate the reabsorption of bicarbonate in the proximal tubule cells in order to compensate acidotic plasma conditions.

In addition, several metabolites are secreted or reabsorbed via various cation and anion transporters. The proximal tubule secretes exogenous metabolites such as penicillin and organic bases such as choline and histamine [4]. Some of the excreted substances end up in the terminal urine, which serves the detoxifying function of the kidney. Ammonia ( $\text{NH}_3$ ) is secreted to buffer luminal protons. Urate, a metabolite accumulating in gout (see chapter “Gout and hyperuricemia”), is reabsorbed in the proximal tubule.

Under fasting conditions, the epithelial cells of the cortical tubular system are able to generate glucose. This occurs to a lesser extent than in the liver. The kidney uses lactate and glutamine as substrates for glucose formation via gluconeogenesis.

In the thin descending limb of Henle, water is mainly reabsorbed without the reabsorption of sodium resulting in a hyperosmolar urine, which is further concentrated in the thick ascending loop of Henle (Fig. 1f). Here, the  $\text{Na-K-Cl}$  cotransporter (NKCC2) on the basal cell surface is crucially involved in actively taking up all three mentioned ions [5]. Cells in the loop of Henle are therefore largely dependent on respiratory mitochondrial ATP generation and are the first cells to detruede during malperfusion of the kidney (e.g., in acute kidney failure; compare with chapter “Chronic kidney disease”). Since the epithelium of the ascending loop of Henle is non-permeable to water, it releases a hypotonic urine. The large export of sodium from this segment of the loop of Henle is responsible for the accumulation of salt and urea in the kidney medulla and generates a corticomedullary osmolarity gradient. The diffusion of  $\text{K}^+$  back into the lumen generates a positive transluminal potential. This facilitates paracellular  $\text{Mg}^{2+}$  and  $\text{Ca}^{2+}$  reabsorption.

The regulation of salt and water excretion takes place in the principal cells of the collecting duct (Fig. 1h). Upon stimulation with aldosterone,  $\text{Na}^+$  is reabsorbed in exchange to  $\text{K}^+$  [6]. Aldosterone increases both expression and activity of the apical sodium channel ENaC. Upon stimulation with antidiuretic hormone (ADH or vasopressin), water is reabsorbed passively due to the corticomedullary osmolarity gradient. In addition, urea is passively reabsorbed via specific urea transporters. Urea is taken up by the vasa recta and circulates between inner and outer medulla (recycling of urea) [7]. Urea diffusion is mediated via urea transporters UT-A1, UT-A2, and UT-A3, which are abundantly expressed in the medullary parts of collecting ducts, loop of Henle, and vasa recta. Both water and urea transport are crucial for the final concentration of urine and fine-tunes diuresis.

Interspersed between the principal cells in the collecting duct, intercalated cells regulate the acid-base metabolism (Fig. 1h) [8]. Type A intercalated cells actively secrete  $\text{H}^+$  ions (via an apical  $\text{H}^+/\text{K}^+$ -ATPase), whereas type B intercalated

cells actively secrete  $\text{HCO}_3^-$  (via a cotransporter). These processes are of crucial importance for the maintenance of acid-base homeostasis and can be differentially regulated in conditions of acid-base imbalances. For example, in acidic conditions, type A intercalated cells increase their capacity to secrete protons into the urine.

---

### **Inside-In: Metabolites of the Kidney Affecting the Kidney Itself**

Autoregulatory mechanisms maintain renal plasma flow and GFR almost constant over a wide range of renal arterial pressure. For example, at a low renal arterial pressure, GFR is kept constant by either increasing the diameter of the afferent arteriole, using prostaglandins and components of the kinin-kallikrein system released from vascular endothelial cells, or decreasing the diameter of the efferent arteriole, using angiotensin II (AT II) acting via AT II receptors. Arteriolar resistance is also under intrinsic myogenic control, meaning that arteriolar smooth muscle cells can contract autonomously if they are stretched by increased blood flow. In addition, GFR is regulated by the tubuloglomerular feedback, as well as norepinephrine and other hormones (see below). The tubuloglomerular feedback mechanism relies on specialized cells in the macula densa at the end of the thick ascending tubule where the loop of Henle passes its own glomerulus. These cells release adenosine and nitric oxide (NO) in response to a decrease in  $\text{Cl}^-$  concentration in the tubular fluid indicative of a decreasing GFR. Both signals lead to afferent arteriole dilatation, hence a rise in glomerular perfusion pressure [9].

In addition, the macula densa cells stimulate the release of the protease renin by the juxtaglomerular cells into the afferent arteriole in response to detection of hypoosmolar urine. The release of renin and activation of the subsequent AT cascade (the renin-angiotensin-aldosterone system; see below) also result in an efferent vasoconstriction thus further increasing GFR. Both the tubuloglomerular feedback and the release of renin ascertain GFR and distal flow at a constant rate.

### **Inside-Out: Metabolites of the Kidney Affecting Other Tissues**

The kidneys are active endocrine organs and produce several hormones to regulate miscellaneous functions, for example, systemic hemodynamics (modulation of blood pressure and body fluids via renin, prostaglandins, kinins; see chapter “[Hypertension](#)”), erythropoiesis (via erythropoietin; see chapter “[Overview](#)” under the part “[Blood](#)”), and mineral metabolism (via calcitriol; see chapter “[Osteoporosis](#)” and Fig. 2).

As stated above, renin is secreted by the juxtaglomerular cells. In addition, a decrease in systemic or renal perfusion pressure activates cardiopulmonary baroreceptors leading to an increased activity of the sympathetic nervous system inducing the release of renin via binding of norepinephrine to  $\beta_1$ -adrenergic receptors. In the plasma, renin cleaves angiotensinogen (synthesized by the liver) to AT I, which is subsequently cleaved by the angiotensin-converting enzyme (ACE) localized in pulmonary arterioles. The end product of this cleavage reaction, the octapeptide AT II, increases blood pressure via direct vascular effects and via release of aldosterone from the adrenal gland (using  $\text{AT}_1$  receptors; see also chapter “[Hypertension](#)”).

Erythropoietin (EPO) is a 34 kDa-sized polypeptide hormone and is secreted by endothelial cells of peritubular capillaries in response to hypoxia. It acts on stem cells in the bone marrow to increase production of hemoglobin and erythrocytes. Chronic kidney failure is associated with normochromic, normocytic anemia (i.e., reduced number of normal red blood cells) due to reduced EPO production (see chapter “[Chronic kidney disease](#)”).

As regards to vitamin D metabolism (see chapter “[Overview](#)” under the part “[Teeth and bones](#)”), calcidiol is hydroxylated to calcitriol in proximal tubular cells via  $1\alpha$ -hydroxylase that is stimulated by parathyroid hormone (PTH). Calcitriol mediates calcium and phosphate uptake by the gut and enhances bone resorption of calcium and phosphate. In addition, calcitriol binds to specific receptors in the parathyroid gland to

**Fig. 2** Schematic overview of kidney metabolites affecting body homeostasis as well as body metabolites affecting the kidney. *PTH* parathyroid hormone, *ADH* antidiuretic hormone, *RAAS* renin-angiotensin-aldosterone system, *AT2* angiotensin II receptor type 2, *GFR* glomerular filtration rate, *ANP* atrial natriuretic peptide

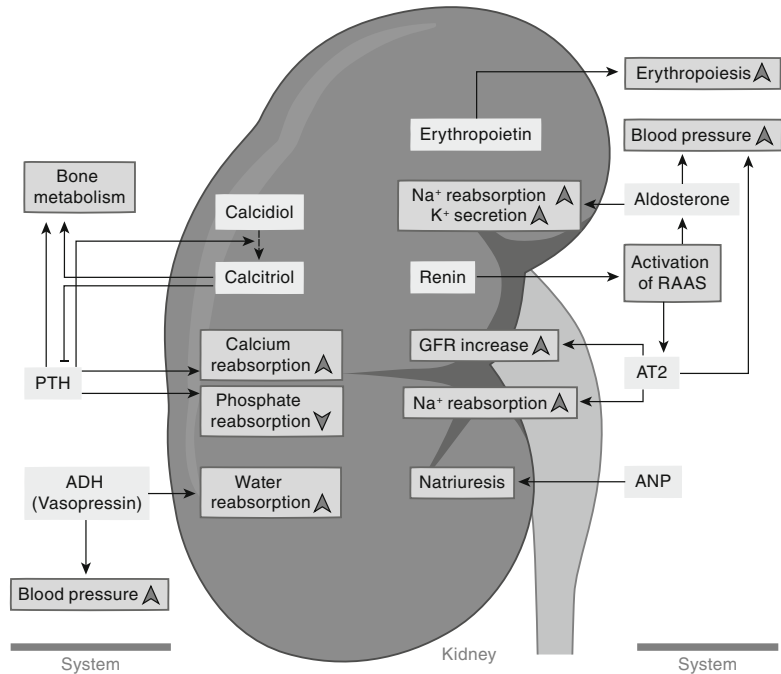

inhibit PTH release as part of a negative feedback loop (see also chapter “[Overview](#)” under the part “Teeth and bones”).

### Outside-In: Metabolites of Other Tissues Affecting the Kidney

Kidney function is under tight regulation by a variety of stimuli and fine-tunes water and salt metabolism as well as blood pressure (Fig. 2).

The atrial natriuretic factor (ANF), also known as atrial natriuretic peptide (ANP), is a peptide hormone secreted by the cardiac atria in response to an increase in atrial pressure (see chapter “[Overview](#)” under the part “Heart”). It directly relaxes the afferent arteriole of the glomeruli, thereby increasing GFR, and it induces an increase in sodium excretion, mainly via direct effects on the proximal tubule.

PTH is a key hormone of calcium metabolism. It is secreted by the parathyroid glands in response to decreased plasma calcium ( $\text{Ca}^{2+}$ ) levels. It leads to massive calcium and phosphate release from the skeletal system. In the kidney, PTH increases calcium reabsorption in the distal

tubule and decreases phosphate reabsorption in the proximal tubule via its G-protein-coupled receptor (called PTH receptor, Fig. 1g) [10]. In addition, it stimulates calcitriol production in the proximal tubule, which is responsible for increased  $\text{Ca}^{2+}$  and  $\text{PO}_4^{3-}$  absorption from the gut. Renal failure is associated with increased PTH levels already evident at early stages of chronic kidney disease most likely due to decreased  $\text{Ca}^{2+}$  levels (see chapter “[Chronic kidney disease](#)”).

ATII, the final effector of the renin-angiotensin-aldosterone system, causes efferent arteriole constriction and thus an increase in GFR. In general, it increases blood pressure via its vasoconstrictive effect mediated by the  $\text{AT}_1$  receptor. ATII directly acts on the distal part of the nephron to increase  $\text{Na}^+$  and  $\text{HCO}_3^-$  reabsorption. In addition, ATII triggers release of the steroid hormone aldosterone from the adrenal glands, which increases  $\text{Na}^+$  reabsorption via increased expression and apical localization of epithelial  $\text{Na}^+$  channels in the distal tubules and increases  $\text{K}^+$  secretion via the renal outer medullary potassium channels [2]. It also leads to an increase in  $\text{H}^+$  secretion. Adrenal insufficiency, as in Addison’s disease, is associated with

decreased aldosterone levels, decreased  $\text{Na}^+$ , and increased  $\text{K}^+$  levels.

Vasopressin is a polypeptide hormone that is secreted by the posterior pituitary (see chapter “[Overview](#)” under the part “Brain”) in response to increased plasma osmolarity and decreased blood volume. It binds to basolateral receptors on principal cells of the collecting duct, i.e. the vasopressin-2 (V2) receptor, a G-protein-coupled receptor signaling through increased levels of cAMP and subsequent activation of PKA. This leads to increased translocation of the water channel aquaporin-2 (AQP2) to the apical cell surface (Fig. 1h). Water is then reabsorbed transcellularly via apical AQP2 and basolateral AQP3 and AQP4 channels [11]. Thus, vasopressin increases passive water reabsorption. Failure of this system leads to diabetes insipidus, a disease associated with urinary output of up to 20 l/day. Increased vasopressin secretion under pathophysiological conditions leads to dilutional hyponatremia. Besides its antidiuretic function, vasopressin directly increases blood pressure via arteriole constriction mediated by activation of the V1a receptor on arteriolar smooth muscle cells (see chapter “[Hypertension](#)”).

---

## Final Remarks

The kidney serves important functions for body homeostasis including (1) regulation of water and electrolyte metabolism, (2) regulation of acid-base homeostasis, (3) detoxification and excretion of waste products, (4) reabsorption of

glucose and other essential metabolites, (5) endocrine function, and (6) synthesis of glucose under fasting conditions. Perturbation of these functions is seen in a variety of pathophysiological conditions.

---

## References

1. Pavenstädt H, Kriz W, Kretzler M (2003) Cell biology of the glomerular podocyte. *Physiol Rev* 83(1):253–307
2. Greger R (2000) Physiology of renal sodium transport. *Am J Med Sci* 319(1):51–62
3. Wright EM (2001) Renal  $\text{Na}^+$ -glucose cotransporters. *Am J Physiol Renal Physiol* 280(1):F10–F18
4. Pritchard JB, Miller DS (1993) Mechanisms mediating renal secretion of organic anions and cations. *Physiol Rev* 73(4):765–796
5. Greger R, Schlatter E, Hebert SC (2001) Milestones in nephrology: presence of luminal  $\text{K}^+$ , a prerequisite for active  $\text{NaCl}$  transport in the cortical thick ascending limb of Henle’s loop of rabbit kidney. *J Am Soc Nephrol* 12(8):1788–1793
6. Lang F, Rehwald W (1992) Potassium channels in renal epithelial transport regulation. *Physiol Rev* 72(1):1–32
7. Knepper MA, Roch-Ramel F (1987) Pathways of urea transport in the mammalian kidney. *Kidney Int* 31(2):629–633
8. Al-Awqati Q (2013) Cell biology of the intercalated cell in the kidney. *FEBS Lett* 587(13):1911–1914
9. Schnermann J, Levine DZ (2003) Paracrine factors in tubuloglomerular feedback: adenosine, ATP, and nitric oxide. *Annu Rev Physiol* 65:501–529
10. Hernando N, Forster IC, Biber J, Murer H (2000) Molecular characteristics of phosphate transporters and their regulation. *Exp Nephrol* 8(6):366–375
11. Nielsen S, Frøkiaer J, Marples D, Kwon T-H, Agre P, Knepper MA (2002) Aquaporins in the kidney: from molecules to medicine. *Physiol Rev* 82(1):205–244

---

# Hypertension

Colleen Flynn and George L. Bakris

---

## Introduction to Hypertension

Primary hypertension is a genetic disease expressed phenotypically as elevated blood pressure (BP) earlier in lifespan than would occur with normal aging [1]. Expression is based on environmental factors such as diet and exercise [1]. Hypertension can occur independently, but it is also a key component of the metabolic syndrome, which is a collection of cardiovascular risk factors including abdominal obesity, impaired glucose tolerance, and dyslipidemia (see chapter “[Metabolic syndrome](#)”) [2].

There is a clear relationship between obesity and hypertension [3]. The prevalence of primary hypertension is increasing as obesity rates increase in developed countries with hypertension being the most prevalent risk factor contributing to the development of cardiovascular disease and chronic kidney disease (see chapters “[Atherosclerotic heart disease](#)” and “[Chronic kidney disease](#)”) [1, 4]. Besides abdominal obesity, excessive  $\text{Na}^+$  intake is a major risk factor in the development of hypertension [5].

---

C. Flynn, MD • G.L. Bakris (✉)  
Section of Endocrinology, Diabetes and Metabolism,  
ASH Comprehensive Hypertension Center,  
The University of Chicago Medicine,  
5841 S. Maryland Ave MC 1027, Chicago, IL, USA  
e-mail: [colleen.flynn@uchospitals.edu](mailto:colleen.flynn@uchospitals.edu);  
[gbakris@gmail.com](mailto:gbakris@gmail.com)

---

## Pathophysiology of Hypertension and Metabolic Alterations

Excessive  $\text{Na}^+$  ingestion, smoking, obesity, and excessive alcohol intake are primary factors that increase risk of persistent elevations of BP among those genetically predisposed to hypertension [5, 6]. Several mechanisms contribute to the development of hypertension. Excess weight gain is associated with  $\text{Na}^+$  and fluid retention as well as increases in components of the renin-angiotensin-aldosterone system (RAAS; see chapter “[Overview](#)” under the part “[Kidney](#)”). Both contribute to the development of hypertension.

There is a dose-dependent relation between  $\text{Na}^+$  intake and BP secondary to the kidneys trying to excrete the excess sodium load. Effectively high  $\text{Na}^+$  levels cause retention of water in the kidney and an increase in fluid volume, which causes higher pressure. Counter-regulatory mechanisms (mainly the RAAS) keep the BP in range, yet these mechanisms are often compromised in patients developing hypertension.

An additional mechanism to raise BP in obese subjects is an increase in plasma renin and angiotensin-converting enzyme (ACE) activity and in plasma angiotensinogen (AGT), angiotensin (Ang II, and aldosterone levels [6]. Adipose tissue itself produces AGT, and its concentration is correlated with body mass index and hypertension [7] as AGT leads to enhanced production of aldosterone by the adipocyte itself. AGT and Ang II also play a local role in adipocyte differentiation and metabolism [8].



## Treatment of Hypertension

The foundation for treating hypertension in the general population with obesity or diabetes includes a low sodium (2 g/day), high potassium diet along with exercise to maintain a nonobese weight range, i.e., body mass index <30 kg/m<sup>2</sup>. The Dietary Approach to Stop Hypertension diet [9] for hypertension control in the general population includes a low sodium diet (<1.5 g/day), rich in fruits and vegetables (8–10 servings/day). The Dietary Approach to Stop Hypertension-sodium trial found a dose-dependent relationship between sodium intake and BP regardless of race or BP level [10].

Dietary restrictions are critical in all hypertension patients simultaneous to drug treatment and in mild cases can even be sufficient to effectively lower BP. Moreover, failure to adhere to dietary restriction will negate the benefits of antihypertensive medication.

The differential effects of Na<sup>+</sup> restriction in different patient groups are, in part, related to their RAAS activity, i.e., the lower the renin state, the less likely a low Na<sup>+</sup> diet will help lower BP [11]. A high K<sup>+</sup> diet can counteract the BP raising effects of high sodium intake in part by preventing the vasoconstriction due to high Na<sup>+</sup> diets [12]. The exact mechanism is unclear but likely involves regulation at the level of renal tubular cells. High levels of K<sup>+</sup> increase the intracellular pH, as high extracellular K<sup>+</sup> levels prevent K<sup>+</sup> from leaving the cells, thus inhibiting H<sup>+</sup> influx. This in turn inhibits the activity of the renal tubular Na<sup>+</sup>/H<sup>+</sup> antiporter causing excretion of Na<sup>+</sup>. Additionally, a direct effect in the endothelium is discussed. Reduced serum K<sup>+</sup> levels can even blunt the activity of antihypertensive agents due to sustained vasoconstriction [12]. In addition to diet changes, obese patients should reduce their weight [9], as weight loss of more than 3–5 kg in patients with BMIs between 30 and 40 results in BP reduction [13].

There are seven classes of antihypertensive medications available. A summary of the effects of each class on metabolic variables in people with obesity or diabetes is summarized in Table 1.

Initial single-pill combination therapy containing two different antihypertensive medications is indicated if BP is >20/10 mmHg above the goal of 140/90 mmHg [14]. Current guidelines recommend starting treatment with an RAAS blocker and combining it with a calcium channel blocker (CCB) or thiazide-like diuretic as initial therapy [15, 16].

The RAAS blockers include ACE inhibitors and angiotensin receptor blockers (ARBs). ACE inhibitors decrease production of Ang II by preventing the conversion of Ang I to Ang II. They also increase bradykinin, a vasodilating peptide and the major determinant of BP reduction after 6 months of therapy, as Ang II levels return to baseline [17]. ACE inhibitors also indirectly reduce sympathetic nervous system activity [18].

ARBs selectively block angiotensin type 1 receptors and thus reduce vasoconstriction and arterial wall growth effects of Ang II. Clinical outcome data show slowing of advanced diabetic nephropathy progression [19].

Among the CCBs, there are dihydropyridine (amlodipine and others) and non-dihydropyridine drugs (verapamil, diltiazem). Both types reduce vascular resistance through L-channel blockade, reducing intracellular Ca<sup>2+</sup> and thus actin-myosin-based contractions, which require Ca<sup>2+</sup> [20]. The non-dihydropyridine CCBs also lower heart rate and urinary protein excretion [20].

Thiazide-like diuretics (chlorthalidone, indapamide) act by inhibiting the Na-K-Cl cotransporter in the distal convoluted tubule, thereby increasing urinary excretion [21].

Other important antihypertensive classes include  $\beta$ -blockers including vasodilating  $\beta$ -blockers, aldosterone blockers, and  $\alpha$ -blockers [22].  $\beta$ -Blockers lower BP through renin inhibition, primarily. These agents reduce heart rate and cardiac output, reduce vasomotor tone, reset baroreceptor levels, and reduce the response to catecholamines [23], as they bind to, and block, adrenergic  $\beta$ -receptors, mainly  $\beta_1$ .

Selective antagonists of the adrenergic  $\alpha$ -1 receptor block postsynaptic effects of norepinephrine, leading to balanced arterial and venous dilation with no increase in cardiac output [23] via sympathetic regulation.

**Table 1** Metabolic effects of obesity and impact of antihypertensive medications

	Baseline status without treatment	RAAS Blocker	CCB	Thiazide diuretics	α-Blockers	β-Blockers	Vasodilating β-blockers	Vasodilators	Aldosterone blockade
Insulin resistance	▲	▼	◀▶	▲▲	▼	▲	▼	▲	◀▶
Fasting glucose	▲	◀▶	◀▶	▲▲	▼	▲	▼	▲	
Triglycerides	▲	◀▶	◀▶	▲▲		▲	▼	◀▶	◀▶
Uric acid	▲	◀▶	◀▶	▲▲	◀▶	◀▶	◀▶	◀▶	◀▶
Serum potassium	◀▶	▲	◀▶	▼	◀▶	◀▶	◀▶	n/a	▲
Increased visceral fat		▼	◀▶	▲	◀▶	n/a	n/a	n/a	n/a
Elevated CRP		▼	◀▶	▲	n/a	n/a	n/a	n/a	▼
Microalbuminuria	◀▶	▼	▼	▼	◀▶	▼	▼	▲	▼
Weight gain		◀▶	◀▶	▼	◀▶	▲▲	▲	▲	▼

Baseline status indicates the variables before treatment. *HS-CRP* C-reactive protein, *n/a* not available, *CCB* calcium channel blockers

RAAS blocker refers to angiotensin-converting enzyme inhibitors and angiotensin receptor blockers

Thiazide diuretics refer to hydrochlorothiazide, indapamide, and chlorthalidone

Vasodilating β-blockers refer to carvedilol and nebivolol

Vasodilators refer to hydralazine and minoxidil

Weight gain is in reference to increases of 1–2 kg from baseline; double arrows refer to 3–4 kg weight gain. A downward arrow indicates reduced weight gain

Note: The use of one agent that worsens a variable is not necessarily counteracted by one that improves that variable



Lastly, arterial vasodilators (e.g., hydralazine, minoxidil) are used in patients with resistant hypertension or those who cannot tolerate one of the other vasodilating classes [22]. These agents work by direct vasodilation of arteries (hydralazine) or by opening barium-sensitive  $K^+$  channels in the arteries leading to vasodilation.

---

## Influence of Treatment on Metabolism and Consequences for Patients

Of the initially recommended three classes of agents (i.e., RAAS blockers, CCBs, and thiazide diuretics), only diuretics are associated with adverse metabolic effects. A meta-analysis demonstrated the lowest incidence of type 2 diabetes with an ACE inhibitor or ARB use [24].

Initially, thiazide-like diuretics reduce extracellular fluid volume, cardiac preload, and cardiac output. With chronic use, thiazide diuretics lead to a decrease in systemic vascular resistance as the extracellular fluid volume and cardiac output return toward baseline [21]. By increasing  $Na^+$  availability at the distal tubule, thiazides also lead to increased excretion of  $Mg^{2+}$  and  $K^+$  (through various  $Na^+/K^+$  channels at the distal tubule) in the loop of Henle, potentially causing hypokalemia. The latter is due to the fact that resorbed  $Na^+$  is transported to the blood via the  $Na^+/K^+$ -ATPase and that the  $K^+$  that entered the cell is mostly excreted. Additionally, thiazide diuretics worsen glycemic status through hypokalemia and other mechanisms related to increased visceral adiposity, the mechanism of which is unknown [16]. Moreover, this risk of diuretic-associated diabetes occurs only in people with impaired fasting glucose and is not totally prevented by combining with an ACE inhibitor or ARBs [25].

Most  $\beta$ -blockers produce significant weight gain and are associated with an increased incidence of type 2 diabetes by worsening insulin sensitivity and glucose homeostasis [23]. While vasodilating  $\beta$ -blockers (carvedilol and nebivolol) may not have these negative metabolic effects, they do cause some weight gain albeit about 50 % less than the traditional  $\beta$ -blockers [26, 27].

Selective antagonists of the adrenergic  $\alpha$ -1 receptor can cause orthostatic hypotension.

RAAS blockers have demonstrated positive or neutral effects on the development of metabolic conditions as they improve insulin sensitivity (secondary to reductions in ANG II, which lead to vasodilation and enhanced insulin utilization by the skeletal muscle related to improved blood flow), increase adiponectin levels (see chapter “[Diabetes mellitus](#)”), and do not cause weight gain [28].

---

## Perspectives

The development of hypertension is closely associated with abdominal obesity and often seen in patients with other metabolic diseases such as diabetes mellitus (see chapter “[Diabetes Mellitus](#)”). Overall, a decrease in cardiovascular risk results from the quantity of BP lowering, relatively independent of the class of agent. A recent analysis has shown that diuretic-induced diabetes does not increase cardiovascular events if the diabetes is treated [29]. Likewise, new guidelines will recommend RAAS blockers or CCBs to be first-line agents along with thiazide diuretics in people with metabolic diseases such as diabetes. Thus, lowering BP to  $<140/90$  mmHg to reduce cardiovascular risk and protect the kidneys without exacerbating or causing metabolic disorders should be the prime objective.

Based on recent observations from both post hoc analyses and prospective trials, the BP range associated with maximal reduction of cardiovascular events including myocardial infarction and heart failure (see chapter “[Heart failure](#)”) is between 130–139 and 70–84 mmHg. The data for stroke (see chapter “[Stroke](#)”) suggest even lower BP levels (i.e., 115–125 mmHg systolic), to provide better risk reduction. All studies show a linear increase in risk for coronary heart disease (see chapter “[Atherosclerotic heart disease](#)”) events in those with systolic BP levels above 140 mmHg.

Newer interventions (i.e., renal denervation and baroreceptor activation) aim to reduce sympathetic neuronal traffic to help control resistant

or refractory hypertension in the small subgroup that requires more than three medications and still has systolic BP levels above 160 mmHg. These procedures are not approved in the United States, and only renal denervation is approved in Europe and Australia.

## References

- Giles TD, Materson BJ, Cohn JN, Kostis JB (2009) Definition and classification of hypertension: an update. *J Clin Hypertens (Greenwich)* 11:611–614
- Kannel WB, Garrison RJ, Dannenberg AL (1993) Secular blood pressure trends in normotensive persons: the Framingham Study. *Am Heart J* 125:1154–1158
- Must A, Spadano J, Coakley EH, Field AE, Colditz G, Dietz WH (1999) The disease burden associated with overweight and obesity. *JAMA* 282:1523–1529
- Egan BM, Zhao Y, Axon RN (2010) US trends in prevalence, awareness, treatment, and control of hypertension, 1988–2008. *JAMA* 303:2043–2050
- Chobanian AV, Bakris GL, Black HR, Cushman WC, Green LA, Izzo JL Jr, Jones DW, Materson BJ, Oparil S, Wright JT Jr, Rocella EJ (2003) The seventh report of the Joint National Committee on Prevention, Detection, Evaluation, and Treatment of High Blood Pressure: the JNC 7 report. *JAMA* 289:2560–2572
- Goodfriend TL, Calhoun DA (2004) Resistant hypertension, obesity, sleep apnea, and aldosterone: theory and therapy. *Hypertension* 43:518–524
- Massiéra F, Bloch-Faure M, Ceiler D, Murakami K, Fukamizu A, Gasc JM, Quignard-Boulangé A, Negrel R, Ailhaud G, Seydoux J, Meneton P, Teboul M (2001) Adipose angiotensinogen is involved in adipose tissue growth and blood pressure regulation. *FASEB J* 15:2727–2729
- Sharma AM (2002) Adipose tissue: a mediator of cardiovascular risk. *Int J Obes Relat Metab Disord* 26(Suppl 4):S5–S7
- Appel LJ, Brands MW, Daniels SR, Karanja N, Elmer PJ, Sacks FM (2006) Dietary approaches to prevent and treat hypertension: a scientific statement from the American Heart Association. *Hypertension* 47:296–308
- Bray GA, Vollmer WM, Sacks FM, Obarzanek E, Svetkey LP, Appel LJ (2004) A further subgroup analysis of the effects of the DASH diet and three dietary sodium levels on blood pressure: results of the DASH-Sodium Trial. *Am J Cardiol* 94:222–227
- He FJ, Markandu ND, MacGregor GA (2001) Importance of the renin system for determining blood pressure fall with acute salt restriction in hypertensive and normotensive whites. *Hypertension* 38:321–325
- Adrogué HJ, Madias NE (2007) Sodium and potassium in the pathogenesis of hypertension. *N Engl J Med* 356:1966–1978
- Hooper L, Abdelhamid A, Moore HJ, Douthwaite W, Skeaff CM, Summerbell CD (2012) Effect of reducing total fat intake on body weight: systematic review and meta-analysis of randomised controlled trials and cohort studies. *BMJ* 345:e7666
- Gradman AH, Basile JN, Carter BL, Bakris GL (2011) Combination therapy in hypertension. *J Clin Hypertens (Greenwich)* 13:146–154
- Bakris GL, Sarafidis PA, Weir MR, Dahlöf B, Pitt B, Jamerson K, Velazquez EJ, Staikos-Byrne L, Kelly RY, Shi V, Chiang YT, Weber MA (2010) Renal outcomes with different fixed-dose combination therapies in patients with hypertension at high risk for cardiovascular events (ACCOMPLISH): a prespecified secondary analysis of a randomised controlled trial. *Lancet* 375:1173–1181
- Eriksson JW, Jansson PA, Carlberg B, Hägg A, Kurland L, Svensson MK, Ahlström H, Ström C, Lönn L, Ojbrandt K, Johansson L, Lind L (2008) Hydrochlorothiazide, but not Candesartan, aggravates insulin resistance and causes visceral and hepatic fat accumulation: the mechanisms for the diabetes preventing effect of Candesartan (MEDICA) Study. *Hypertension* 52:1030–1037
- Gainer JV, Morrow JD, Loveland A, King DJ, Brown NJ (1998) Effect of bradykinin-receptor blockade on the response to angiotensin-converting-enzyme inhibitor in normotensive and hypertensive subjects. *N Engl J Med* 339:1285–1292
- Schmieder RE, Hilgers KF, Schlaich MP, Schmidt BM (2007) Renin-angiotensin system and cardiovascular risk. *Lancet* 369:1208–1219
- Bakris GL (2011) Recognition, pathogenesis, and treatment of different stages of nephropathy in patients with type 2 diabetes mellitus. *Mayo Clin Proc* 86:444–456
- Fleckenstein A, Fleckenstein-Grün G (1988) Mechanism of action of calcium antagonists in heart and vascular smooth muscle. *Eur Heart J* 9(Suppl H):95–99
- Sica DA, Carter B, Cushman W, Hamm L (2011) Thiazide and loop diuretics. *J Clin Hypertens (Greenwich)* 13:639–643
- Ferdinand KC (2011) A compendium of antihypertensive therapy. *J Clin Hypertens (Greenwich)* 13:636–638
- Frishman WH, Saunders E (2011) beta-Adrenergic blockers. *J Clin Hypertens (Greenwich)* 13:649–653
- Elliott WJ, Meyer PM (2007) Incident diabetes in clinical trials of antihypertensive drugs: a network meta-analysis. *Lancet* 369:201–207
- Bakris G (2009) An in-depth analysis of vasodilation in the management of hypertension: focus on adrenergic blockade. *J Cardiovasc Pharmacol* 53:379–387
- Bakris GL, Fonseca V, Katholi RE, McGill JB, Messerli FH, Phillips RA, Raskin P, Wright JT Jr, Oakes R, Lukas MA, Anderson KM, Bell DS (2004) Metabolic effects of carvedilol vs metoprolol in patients with type 2 diabetes mellitus and

- hypertension: a randomized controlled trial. *JAMA* 292:2227–2236
27. Manrique C, Lastra G, Habibi J, Pulakat L, Schneider R, Durante W, Tilmon R, Rehmer J, Hayden MR, Ferrario CM, Whaley-Connell A, Sowers JR (2011) Nebivolol improves insulin sensitivity in the TGR(Ren2)27 rat. *Metabolism* 60:1757–1766
  28. Flynn C, Bakris GL (2011) Interaction between adiponectin and aldosterone. *Cardiorenal Med* 1:96–101
  29. Barzilay JI, Davis BR, Pressel SL, Cutler JA, Einhorn PT, Black HR, Cushman WC, Ford CE, Margolis KL, Molloo J, Oparil S, Piller LB, Simmons DL, Sweeney ME, Whelton PK, Wong ND, Wright JT Jr (2012) Long-term effects of incident diabetes mellitus on cardiovascular outcomes in people treated for hypertension: the ALLHAT Diabetes Extension Study. *Circ Cardiovasc Qual Outcomes* 5:153–162

---

# Chronic Kidney Disease

Golaun Odabaei, George A. Kaysen,  
and Shubha Ananthakrishnan

---

## Introduction to Chronic Kidney Disease

Chronic kidney disease (CKD) is a pathological status characterized by decreased glomerular filtration rate (GFR) due to various reasons and with potentially fatal outcome. It affects more than 25 % of the population aged 60 years or older in the United States. The most common causes of CKD are diabetes (see chapter “[Diabetes mellitus](#)”) and hypertension (see chapter “[Hypertension](#)”) collectively being responsible for about 75 % of patients requiring renal replacement therapy.

There is a decline in renal function that occurs in the general population with advancing age, with an approximate loss of GFR of 1 ml/min/year of age after about 30 (starting at a GFR of 100–120 ml/min/1.73 m<sup>2</sup>). As expected, the loss is greater among subjects with underlying risk. Proteinuria is a marker renal injury and may contribute to loss of renal function further injuring the kidney directly. CKD is diagnosed and clas-

sified into five stages according to the GFR, and its clinical symptoms are presented in Table 1. CKD is often diagnosed due to fatigue caused by anemia and azotemia, but these symptoms only appear late in the course of progression (usually stage IV or greater). This chapter will expand on metabolic issues associated with CKD and its management.

---

## Pathophysiology of Chronic Kidney Disease and Metabolic Alterations

CKD results in pathological metabolic changes, namely, increased risk of cardiovascular disease (see chapter “[Atherosclerotic heart disease](#)”), disturbances in mineral and electrolyte metabolism, anemia, and uremia, corresponding to the disease stage.

## Cardiovascular Disease

The kidney performs an essential role in maintenance of volume and electrolyte homeostasis (see chapter “[Overview](#)” under the part “[Kidney](#)”). The part of the extracellular fluid that is in the arterial system leading to perfusion of the tissues is called the effective circulating volume [1]. It is regulated neurologically and hormonally by natriuretic peptides (atrial and brain natriuretic factors, see chapter “[Overview](#)” under the part “[Heart](#)”) and the renin-angiotensin-aldosterone system (RAAS, originating in the kidney) to

---

G. Odabaei • S. Ananthakrishnan  
Division of Nephrology,  
University of California-Davis,  
4150 V Street, Suite 3500,  
Sacramento, CA 95817, USA  
e-mail: [godabaei@yahoo.com](mailto:godabaei@yahoo.com); [shubhaa@gmail.com](mailto:shubhaa@gmail.com)

G.A. Kaysen (✉)  
Division of Nephrology, Department of Biochemistry  
and Molecular Medicine, University of California-Davis,  
GBSF 451 East Health Sciences Drive,  
Davis, CA 95616, USA  
e-mail: [gakaysen@ucdavis.edu](mailto:gakaysen@ucdavis.edu)

**Table 1** Stages of chronic kidney disease

Stage	1	2	3	4	5
GFR (ml/min/1.73 m <sup>2</sup> )	>90	60–90	30–60	15–30	<15
Clinical features	Subtle, asymptomatic		Anemia, risk of CVD, disturbed electrolytes and minerals		Replacement therapy

GFR glomerular filtration rate, CVD cardiovascular disease

maintain fluid homeostasis. Hypertension can develop secondary to an increase in sympathetic neural activity with increased  $\beta$ -adrenergic responsiveness as well as an increase in angiotensin II activity (a part of the RAAS) and mineralocorticoid excess (see chapter “[Hypertension](#)”). Activation of the RAAS increases glomerular pressures and flows, increasing single nephron GFR. This increase in pressure and flow may also accelerate renal injury when kidney disease is advanced. Decrease in the synthesis of a kidney-derived protein, reninase, may also contribute to hypertension. Additionally, aldosterone, by acting on kidney tubules, increases the reabsorption of Na<sup>+</sup> and water. Prolonged exposure to aldosterone (in the setting of volume expansion such as encountered in CKD) contributes to both chronic heart failure (see chapter “[Heart failure](#)”) and progressive renal injury. In CKD, increased blood volume due to reduced GFR, deregulation of hormonal systems, and increased sympathetic neural activity plays a role in the development of secondary hypertension. Consequently, increased blood pressure is common in CKD.

### Mineral and Bone Disorders

CKD is associated with progressive changes in mineral and bone metabolism affecting blood vessels and bone structure and strength. The term “chronic kidney disease-mineral and bone disorder” refers to a syndrome of bone abnormalities and extraskelatal calcifications seen in patients with CKD. Phosphate (P<sub>i</sub>) and Ca<sup>2+</sup> levels are regulated in part by the kidneys (see chapters “[Overview](#)” under the part “Teeth and bones” and “[Overview](#)” under the part “Kidney”) [2]. Low GFR (<50 ml/min/1.73 m<sup>2</sup>) is associated with phosphate retention playing a role in the release of fibroblast growth factor 23 by bone, which in turn increases urinary phosphate excretion,

reduces the synthesis of calcitriol (the active form of vitamin D<sub>3</sub>), and increases parathyroid hormone (PTH) secretion to maintain P<sub>i</sub> homeostasis (Fig 1). Intact (full-length) PTH monitoring should be done frequently and low and high levels treated.

Renal osteodystrophy refers to abnormalities of bone associated with CKD. This can be manifested as osteitis fibrosa cystica (persistent secondary hyperparathyroidism resulting in high-turnover bone disease), osteomalacia (low-turnover bone disease characterized by increased unmineralized osteoid secondary to vitamin D<sub>3</sub> deficiency and hypocalcemia), adynamic bone disease (low-turnover condition secondary to functional hypoparathyroidism due to excess of vitamin D<sub>3</sub> supplements and/or calcium loading). Thus, close monitoring of Ca<sup>2+</sup>, P<sub>i</sub>, vitamin D<sub>3</sub>, and intact PTH is required in CKD patients.

### Acid-base and Electrolyte Disturbances

With advanced kidney disease, hyperkalemia develops due to reduced renal excretion of K<sup>+</sup>. Hyperkalemia is especially common in diabetic kidney disease, due to hyporeninemic hypoaldosteronism, reducing the fractional excretion of K<sup>+</sup> that usually occurs. In CKD, especially in diabetes, renal tubular damage may cause inadequate renin production and release. Adrenal dysfunction may lead to inadequate aldosterone production; and the principal cells of the cortical connecting tubule may not respond normally to aldosterone. In true hyporeninemic hypoaldosteronism, the juxtaglomerular apparatus atrophies. Hyperkalemia can impair neuromuscular conduction, leading to muscle weakness and cardiac conduction abnormalities, including heart blocks and fatal ventricular arrhythmias. Metabolic acidosis develops in advanced CKD, mainly due to

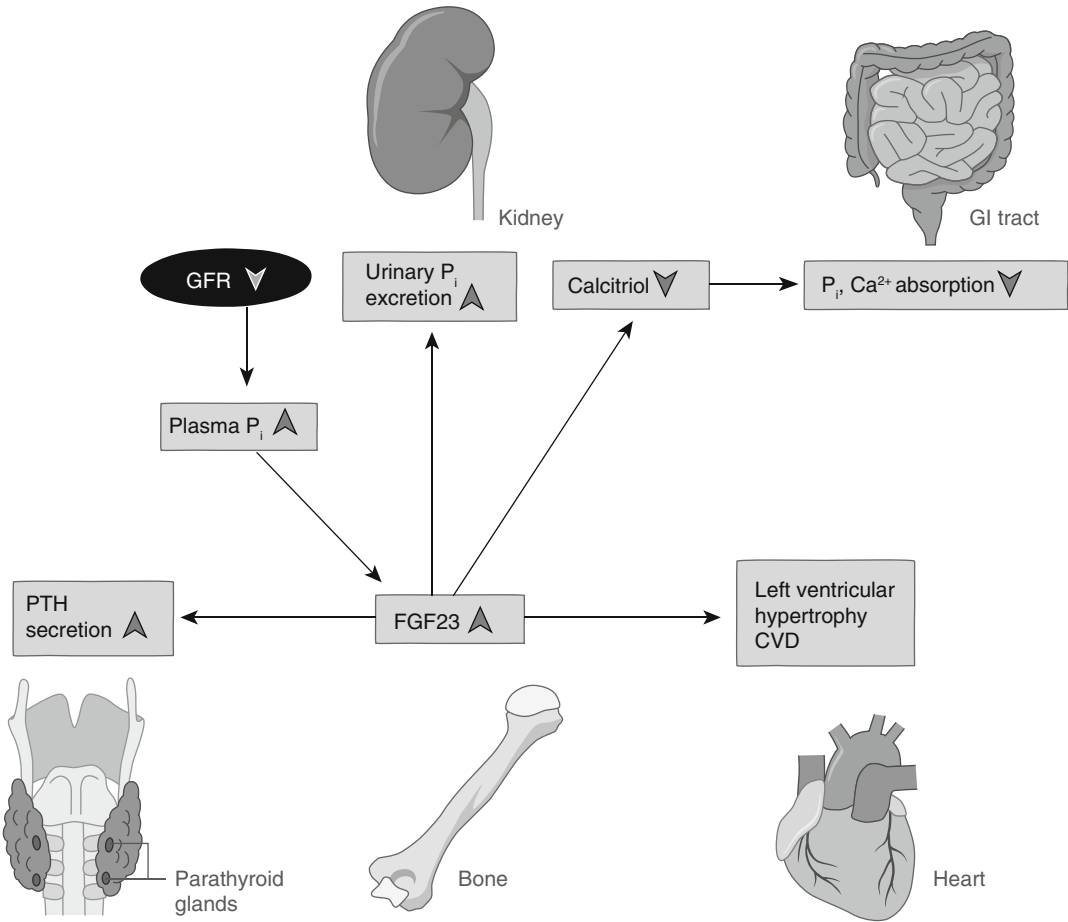

**Fig. 1** Important mechanisms and molecules causing metabolic derangements during chronic kidney disease. As glomerular filtration rate (*GFR*) declines, phosphate ( $P_i$ ) is retained in the kidney, leading to hyperphosphatemia. Increased  $P_i$  in the blood causes release of fibroblast growth factor (*FGF*) 23 from bone. FGF23 acts on the parathyroid glands to increase parathyroid hormone

(*PTH*) secretion. FGF23 also increases  $P_i$  excretion in the urine and reduces synthesis of calcitriol by the kidney. Subsequently, decreased levels of calcitriol cause a reduction in gastrointestinal (*GI*) absorption of  $P_i$  and  $Ca^{2+}$  (see also chapter “**Overview**” under the part “Teeth and bones”). Finally, as the *GFR* continues to decline, rising FGF23 levels lead to cardiovascular disease (*CVD*)

reduced renal ammonium excretion. In addition, there is reduced “titratable acidity” in urine, due to reduced phosphate excretion (also resulting in hyperphosphatemia), the principal buffer present in urine. Hyperkalemia reduces the activity of glutaminase within the kidney, decreasing ammonia production and worsening the metabolic acidosis.

**Anemia**

Anemia, which is a reduction of hemoglobin concentration, is a common complication of

(late-stage) CKD. Erythropoietin (*EPO*) is synthesized by the kidney, and loss of *GFR* is associated with loss of functional renal mass. As *GFR* declines, *EPO* deficiency becomes apparent, leading to anemia, as *EPO* is necessary for the survival of erythroid progenitors and protection of new red cells from cytolysis. Hypoxic kidneys produce hypoxia-inducible factor 1 stimulating *EPO* synthesis [3]. In patients with normal kidney function, sustained anemia or hypoxemia leads to rise in *EPO* levels. However, decreased kidney function in the setting of CKD decreases *EPO* production, leading to anemia. Anemia leads to fatigue and decreased cognitive skills

**Table 2** Uremic solutes

	Solute group (example)	Source	Characteristics
Small, water-soluble	Urea	AA metabolism	Clinical marker Most abundant
	Guanidines		Seizures $\Delta$ Inflammation $\Delta$ Influence on leukocytes
	Oxalate	Diet (ascorbic acid, rhubarb)	Danger of crystal deposits Mostly due to gene mutations
Small lipid-soluble/ protein-bound	Phenols (Cresol)	AA metabolism by gut bacteria	Influence on inflammation Endothelial cells Kidney damage via inflammation
	Indols		Glomerular sclerosis via free radicals and NF $\kappa$ B signaling
	Furans (CMPF)	Unknown	Influences excretion of drugs and metabolites
“Middle molecules”	$\beta$ 2-Microglobulin	Component of MHC, shedding	Poorly dialyzed May cause amyloid depositions

AA amino acid, *CMPF* 3-carboxy-4-methyl-5-propyl-2-furan-propionic acid, *MHC* major histocompatibility complex, *NF- $\kappa$ B* nuclear factor- $\kappa$ B

and sense of well-being and may be associated with cardiovascular complications and left ventricular hypertrophy.

## Uremia

Uremia (literally “urine in the blood”) occurs in end-stage kidney disease and is characterized by retained organic solutes (in the blood, see Table 2) [4] and often accompanies derangements in metabolism of inorganic compounds (such as  $\text{Ca}^{2+}$ ,  $\text{P}_i$ ), hormonal imbalances (such as PTH), and disorders of extracellular volume. In general, three classes of uremic solutes exist (see Table 2): (1) small water-soluble substances, (2) small lipid-soluble or protein-bound substances, and (3) larger so-called middle molecules. Urea, belonging to the first class, is a by-product of protein catabolism and the most abundant of the uremic solutes. It is used clinically for diagnosis of uremia. However, studies have shown that it is probably only a weak toxin per se.

Interestingly, many of the uremic solutes arise from protein or amino acid degradation and/or are generated from bacterial metabolism in the gut. They contribute to CKD, often by increasing inflammatory reactions.

The uremic state also is thought to alter oxidative stress in the body. Several proteins

including albumin are thought to be more oxidized in the uremic state. Lipoprotein structure and function is disordered, with an increased level of oxidized low-density lipoproteins and decreased levels of high-density lipoproteins occurring (see chapter “Hyperlipidemia”). The HDL found in patients with advanced kidney disease is also structurally abnormal. This, combined with the pro-inflammatory state afforded by uremia, and increased insulin resistance, likely puts patients at an increased risk of cardiovascular disease. The classic symptoms of uremia include lethargy, anorexia, itching, and various neurologic manifestations including sleep disturbances, seizures, restless legs (potentially due to reduced membrane potential), and, in advanced cases, coma. Azotemia is the early stage of uremia, in which a change in markers can be measured, but no symptoms are present (yet).

## Introduction to Treatment and Influence on Metabolism

Treatment of CKD focuses mainly on reducing the complications caused by CKD and on prevention of disease progression. Ultimately, CKD can only be treated by replacement therapy, meaning dialysis or kidney transplantation.



## Risk of CVD

Prevention of CVD focuses on relief of hypertension. Diuretics, angiotensin-converting enzyme inhibitors or angiotensin-receptor antagonists, and  $\beta$ -blockers are some of the antihypertensive agents often used in management of patients with CKD (see chapter “[Hypertension](#)”) [5].

## Bone and Mineral Metabolism

Appropriate levels of  $\text{Ca}^{2+}$  are important to prevent hypocalcemia from causing hyperparathyroidism. Thus,  $\text{Ca}^{2+}$  or 1,3 dihydroxy vitamin D supplements are often recommended.

Dietary  $\text{P}_i$  restriction and oral  $\text{P}_i$  binders, mostly inorganic salts, such as calcium acetate (PhosLo), lanthanum carbonate (Fosrenol), or phosphate binding resins (sevelamer), are used to prevent  $\text{P}_i$  absorption in the gut. Thus, they decrease intake of  $\text{P}_i$  to prevent the aforementioned influence on fibroblast growth factor 23. As  $\text{P}_i$  restriction can cause hypercalcemia,  $\text{Ca}^{2+}$  levels should be monitored and  $\text{Ca}^{2+}$  supplements avoided, to prevent elevated calcium-phosphorus product and thus vascular calcification [5].

Low and high levels of PTH are treated to balance  $\text{Ca}^{2+}$  and  $\text{P}_i$  levels. Low levels are treated with PTH analogues (e.g., teriparatide, see chapter “[Osteoporosis](#)”). High levels are treated with calcimimetic agents (e.g., cinacalcet, an allosteric activator of the calcium sensor in the parathyroid glands, see chapter “[Overview](#)” under the part “Teeth and bones”). Ideal treatment can prevent the onset of parathyroid hyperplasia in stage III–IV CKD before the onset of irreversible parathyroid gland growth. Calcimimetic agents, including cinacalcet, lower serum PTH levels and the danger of  $\text{Ca}^{2+}$ - $\text{P}_i$  precipitate (see chapter “[Kidney stones](#)”).

## Acid-base and Electrolytes

Treatment of hyperkalemia is an important component of correcting the defect in ammonia production essential to maintain acid-base

homeostasis (see above). Additionally, correction of metabolic acidosis is important for slowing progression of CKD.

Hyperkalemia in CKD is treated by restricting dietary  $\text{K}^+$  and by use of cation-exchange resins, diuretics, and dialysis therapy, depending on the urgency and stage of kidney disease. Oral or rectal cation exchangers (such as polystyrene sulfonate) can reduce hyperkalemia. However, these can damage the colon and are generally used as a last resort.

Furosemide is the main diuretic used in CKD. It acts by inhibiting the luminal Na-K-Cl symporter in the thick ascending limb of the loop of Henle (see chapter “[Overview](#)” under the part “[Kidney](#)”). By inhibiting the transporter, this loop diuretic reduces the reabsorption of sodium chloride and  $\text{K}^+$ . Finally, this increases urinary volume and cation excretion.

Sodium bicarbonate is sometimes used in CKD patients to improve serum bicarbonate levels and metabolic acidosis. Since bicarbonate is more poorly reabsorbed than chloride in the distal nephron, the electrical gradient is reduced, and, thus, the delivery of bicarbonate (e.g., via sodium bicarbonate) increases renal potassium excretion (as  $\text{K}^+$  absorption is reduced).

## Anemia

Once other treatable causes of anemia (iron deficiency, folate deficiency) have been addressed, erythropoiesis-stimulating agents (such as epoetin and darbepoetin- $\alpha$ ) can be used to counteract the decrease in erythropoietin [3]. This will help decrease symptoms of anemia and possibly the need for transfusions. Epoetin is a protein with identical sequence to EPO, but different glycosylation (profile). Darbepoetin- $\alpha$  differs from EPO in five amino acids, causing additional glycosylation and increased half-life of the protein.

It is unclear what level of hemoglobin is optimal for patients with anemia secondary to reduction in renal mass. Controlled clinical trials attempting to achieve a normal level of hemoglobin have reproducibly found increased cardiovascular events among patients corrected

to a hemoglobin level of 13 g/dl. The current hemoglobin target is 10 g/dl, but even this target may be reduced in the future.

## Uremia

In the true sense of the word, “uremic” symptoms can be treated only with dialysis or by renal transplantation, which removes the “urine components” and promptly corrects most of the symptoms.

Traditional hemodialysis is performed three times a week, for an average of about 3.5 h per session, in the United States. More intensive dialysis such as increase in frequency or in duration has been shown to improve sense of well-being, to restore better sleep quality, and also to reduce left ventricular mass.

---

## Perspectives

In summary, CKD produces an array of metabolic complications in the patient, including anemia, blood volume and electrolyte disorders, and

bone and mineral metabolism abnormalities and symptoms due to accumulation of organic solutes in the blood (uremia). While dialysis corrects these abnormalities at least partially and offers symptom relief from uremia, renal transplantation offers the best hope today for the patient with end-stage kidney disease. Therefore, the focus should be on prevention of CKD.

---

## References

1. Depner TA (2001) Uremic toxicity: urea and beyond. *Semin Dial* 14:246–251
2. Schrier J, Schrier RW (2000) *Manual of nephrology: diagnosis and therapy*, 5th edn. Lippincott Williams & Wilkins, Philadelphia
3. Deng A, Arndt MA, Satriano J, Singh P, Rieg T, Thomson S, Tang T, Blantz RC (2010) Renal protection in chronic kidney disease: hypoxia-inducible factor activation vs. angiotensin II blockade. *Am J Physiol Renal Physiol* 299:F1365–F1373
4. Meyer TW, Hostetter TH (2007) Uremia. *N Engl J Med* 357:1316–1325
5. American College of Physicians; August P (ed) (2010) *MKSAP 15 medical knowledge self-assessment program: nephrology*. American College of Physicians, Philadelphia

---

# Gout

Sonia Nasi and Alexander So

---

## Introduction to Gout

Acute gout is the inflammatory reaction provoked by monosodium urate (MSU) crystals when they form within a joint. It affects mainly males, due to their physiologically higher serum uric acid (UA) levels, and there is epidemiological evidence that the prevalence of gout and hyperuricemia is on the increase in western and Asian populations in both sexes and with aging. It is estimated that the prevalence of gout increased by 60 % in those aged over 65 and doubled in the population over 75 years of age between 1990 and 1999 [1]. The prevalence is estimated to be 1.4 % in the adult population in the UK, with a peak of over 7 % in men aged over 75 years old [2]. In addition, a strong association between hyperuricemia and the metabolic syndrome (see chapter “[Metabolic syndrome](#)”) was observed. Potential explanations include lifestyle and dietary changes brought about by increasing prosperity and increased life expectancy of the population, not to mention the coexistence of multiple medical comorbidities and their treatments (i.e., hypertensive agents) that favor hyperuricemia in the elderly.

---

S. Nasi (✉) • A. So  
Service de Rhumatologie, CHUV,  
Avenue Pierre Decker, 5, Lausanne,  
1011, Switzerland  
e-mail: [sonia.nasi@chuv.ch](mailto:sonia.nasi@chuv.ch);  
[alexanderkai-lik.so@chuv.ch](mailto:alexanderkai-lik.so@chuv.ch)

Gout starts with a first acute attack (flare) followed by an intercritical phase without attacks. Overtime, gout will become chronic (Fig. 1). Diagnosis is based on clinical symptoms and the presence of MSU crystals in the joints.

---

## Pathophysiology of Gout and Metabolic Alterations

UA in body fluid, at pH 7.4, exists in the urate form. It is generated by catabolism of purine nucleotides, which occurs mainly in the liver. The last step consists of the conversion of xanthine to UA, and it is catalyzed by the enzyme xanthine oxidase. Humans, as opposed to other mammals, lack the ability to further degrade urate to allantoin because the enzyme uricase is nonfunctional due to gene mutation [3].

Hyperuricemia is defined as the level of serum urate that exceeds its plasma solubility. This favors crystal formation and deposition in soft tissues and around joints, leading to tophus (aggregates of MSU crystals) formation and triggering an acute inflammatory reaction. In addition, increased urinary concentrations of urate can also lead to renal stone formation (see chapter “[Kidney stones](#)”). Although these renal manifestations are well documented in the literature, they are much less frequently encountered than gout, the most common clinical presentation. Hyperuricemia is either the result of excess formation of urate due to increased purine metabolism or the consequence of insufficient renal

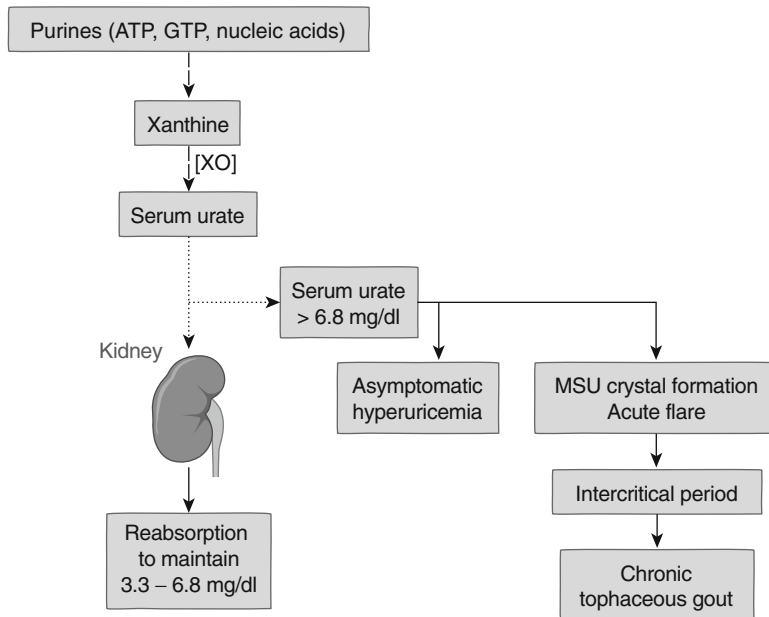

**Fig. 1** Mechanisms and progression of gout. Uric acid is the end point of purine degradation, resulting from the conversion of xanthine by xanthine oxidase (*XO*), and is present in the blood as urate. Urate is filtered by the kidney and is reabsorbed to maintain a serum concentration below 6.8 mg/dl under healthy conditions. Serum urate concentrations can be increased by dietary factors and genetic disorders (not shown). When serum urate levels exceed its solubility (6.8 mg/dl), monosodium urate (*MSU*) crystals may form. Gout progresses through clinically distinct

elimination of urate to maintain normal physiological values, or a mixture of both (Fig. 1).

In the majority of cases, hyperuricemia is mainly explained by diet as well as idiopathic underexcretion of urate by the kidney. Studies confirmed that increased consumption of certain foods, liquor, and sugar-sweetened soft drinks increased the risk of developing gout [4–6]. Meat, seafood, and beer are risky because of their high purine content; sugar-sweetened soft drinks increase risk due to their high fructose content. Excess fructose (in the liver) and also alcohol deplete ATP levels and increase adenine degradation to UA. Other mechanisms to increase UA play a role as well. An additional contributory factor to hyperuricemia, particularly in the older population, is drug-induced underexcretion due to use of thiazide diuretics (see chapter “[Hypertension](#)”) and low-dose aspirin, which reduce the renal excretion of UA.

stages. Initially, the condition is asymptomatic (and can remain so). Crystals can be released into the joint space, triggering an interleukin (IL-1)-dependent inflammatory response, resulting in an acute flare, characterized by severe pain and fever. An initial flare usually resolves in 3–14 days. The periods between acute flares are termed intercritical periods, in which symptoms are absent, but urate crystals are still present in previously involved joints, stimulating low-grade inflammation. In untreated patients, continuing urate accumulation leads to chronic tophus formation

Data from family studies showed that gout and hyperuricemia are polygenic traits [7]. In the kidney, urate undergoes glomerular filtration, tubular reabsorption, and then reexcretion. Most of the genes associated with hyperuricemia are implicated in either the excretion or reabsorption of urate in the renal tubule. The strongest association found is with a urate transporter, solute carrier family 2, facilitated glucose transporter member 9 (SLC2A9) [8].

It is now well established that one of the major mechanisms of gouty inflammation is through release of interleukin-1 $\beta$  (IL-1 $\beta$ ) when MSU crystals are in contact with monocytes and neutrophils. In vitro, MSU crystals are capable of activating the NOD-like receptor family, pyrin domain containing 3 (NLRP3) inflammasome in monocytes and dendritic cells to secrete large quantities of IL-1 $\beta$  (see chapter “[Overview](#)” under the part

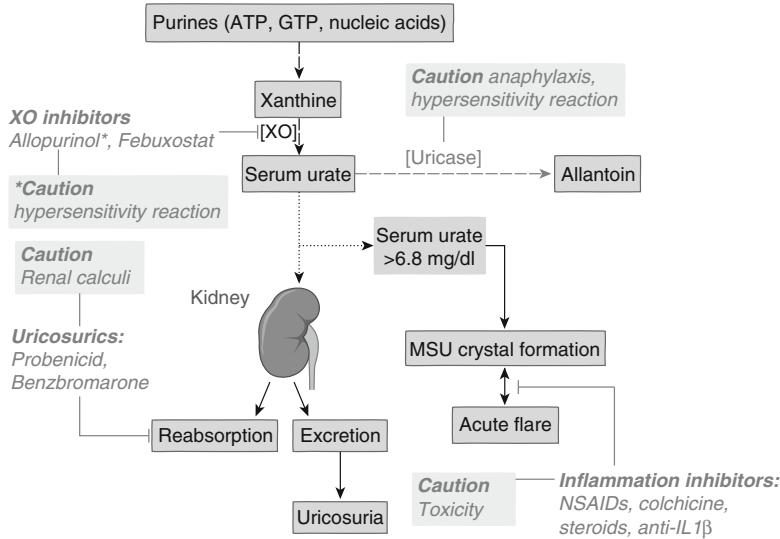

**Fig. 2** Location of the different targets of currently available treatments of acute gout and hyperuricemia. Urate-lowering therapies have three major mechanisms of action: inhibition of xanthine oxidase (XO), addition of uricase, or increased

excretion of urate by the kidney (uricosurics). Inflammation inhibitors relieve the acute signs and symptoms of gout, usually arthritis. MSU monosodium urate, NSAIDs nonsteroidal anti-inflammatory drugs, IL interleukin

“Immune system”) [9]. The NLRP3 inflammasome is a cytoplasmic protein complex composed of NLRP3 (a protein of the NLRP family), an adapter protein, as well as caspase-1. Caspase-1 catalyzes the cleavage of pro-IL-1 $\beta$  and pro-IL-18 into their active forms (IL-1 $\beta$  and IL-18) leading to their secretion. Recently, protein kinase R (an RNA-dependent protein kinase) has been implicated in MSU-stimulated IL-1 $\beta$  release, as genetic deficiency in mice for this molecule blocked IL-1 $\beta$  secretion. Indeed, it interacts physically with the inflammasome to initiate caspase-1 activity [10].

In addition, MSU crystals can elicit inflammation in an inflammasome-independent manner triggering at least two different pathways: one through crystals interacting with the cell surface (dendritic cells and macrophages) to initiate an intracellular signaling cascade that involves spleen tyrosine kinase (Syk), another via the release of pro-IL-1 $\beta$  into the extracellular space during cell activation or cell death, and its subsequent cleavage by serine proteases such as cathepsin G, elastase, and proteinase 3 released by neutrophils at site of inflammation [11]. Finally, novel studies have also shown a role of IL-1 $\alpha$  in the inflammatory process [12].

Since the body cannot react to hyperuricemia with a feedback mechanism or counter-regulation, people with hyperuricemia will remain with high urate levels for all their life, unless treated with urate-lowering agents.

## Treatment of Gout

Gout therapy is based on two principal strategies: the control of hyperuricemia that predisposes to formation of crystals (urate-lowering therapies) and the control of gouty inflammation to calm the acute attack. All patients should be given dietary advice and general counseling of the importance of long-term treatment adherence.

The aim of the first group of therapies is to reduce the serum urate level to below the solubility threshold for crystal formation. Inhibition of xanthine oxidase (XO) is the most widely used approach to control hyperuricemia, and two inhibitors are currently available, allopurinol and febuxostat.

The treatment of acute gout (Fig. 2) aims to relieve pain and inflammation rapidly. Traditional approaches include nonsteroidal

anti-inflammatory drugs (NSAIDs), such as diclofenac and indomethacin, colchicine (a drug that inhibits tubulin polymerization), and corticosteroids. In most cases, these drugs are rapidly effective, but caution has to be exercised in some patients.

NSAIDs can cause side effects such as renal dysfunction and raise blood pressure. The serum concentration of colchicine is influenced by cytochrome P450 3A4 and P-glycoprotein (also called multidrug resistance protein 1) activities, and both enzymes are affected by drug interactions (necessitating close observation of potential co-treatments).

The discovery of the IL-1 axis of gouty inflammation has led to studies that have evaluated the effectiveness of IL-1 inhibitors. They are effective, either in the prevention or in the treatment of an acute flare. The frequency of flares was halved using a monoclonal antibody against IL-1 $\beta$  (Canakinumab), and pain was significantly reduced [13, 14]. Similarly, an inhibitor of both IL-1 $\alpha$  and IL-1 $\beta$  (Riloncept) reduced gout flares by around 50 % [15].

In uncontrolled studies, an IL-1 receptor antagonist called anakinra was effective in the treatment of acute gout in patients who had either intolerance or contraindications to standard therapy [16]. Currently, anakinra is mainly used to treat rheumatoid arthritis (see chapter “[Rheumatoid arthritis](#)”).

Uricosurics are drugs that promote renal urate excretion instead of lowering urate concentrations and include benzbromarone and probenecid. Finally, it is possible to lower serum urate by administration of exogenous uricase, the enzyme responsible for the oxidation of urate to allantoin, whose gene is no longer functional in man.

---

## **Influence of Treatment on Metabolism and Consequences for Patients**

All drugs that reduce serum urate can cause acute flares when treatment is started. This is due to an alteration of the stability of MSU crystals when UA levels decrease suddenly. It is therefore important to provide adequate prophylaxis

against flare for any patient who starts a urate-lowering therapy.

## **Allopurinol (An XO Inhibitor)**

Allopurinol is a purine analogue that is metabolized to active oxypurinol, a potent inhibitor of XO (Fig. 2). The dose of allopurinol required to reduce serum urate levels below the limit of solubility can vary. As the drug is eliminated by the kidney, attention has to be paid to renal function in determining the effective as well as safe maximal dose. The most severe side effect is the allopurinol hypersensitivity syndrome, a Stevens-Johnson’s type reaction that is characterized by fever, skin rashes, and desquamation, liver function abnormalities, and a fatal outcome in a significant proportion of patients.

## **Febuxostat (Non-purine XO Inhibitor)**

Febuxostat is a non-purine selective inhibitor of XO (Fig. 2). In vitro studies showed that febuxostat is a potent ligand for and inhibitor of both the oxidized and reduced forms of XO, and clinical studies have confirmed its efficacy in reducing serum urate levels [17]. Consequently, it raises serum xanthine levels, but this does not present a clinical problem. Febuxostat shows a dose-dependent effect. The side effect profile of febuxostat is comparable to that of allopurinol [18]. The serious adverse events reported included liver function abnormalities and cardiovascular events. Rashes were observed in <2 % of febuxostat-treated patients, but a reaction that resembles the allopurinol hypersensitivity syndrome is not observed.

## **Uricosuric Drugs**

Uricosuric drugs interfere with tubular mechanisms of urate reabsorption to enhance uricosuria, such as the inhibition of the renal/liver transporters SLC2A9 and SLC22A2 (Fig. 2). These drugs should not be used in patients with

high urate excretion, as they can precipitate renal stones or urate nephropathy. Benzbromarone is the most powerful drug in terms of urate reduction but shows serious hepatotoxic side effects severely restricting its distribution. Currently, probenecid is the most frequently prescribed uricosuric.

As probenecid also increases urine calcium excretion, it is contraindicated in patients with a history of renal calculi. Probenecid can interfere with renal excretion of other drugs (penicillins, some antivirals), so a careful drug history is vital before initiating treatment.

## Uricase

This therapy uses exogenous uricase that is chemically linked to polyethylene glycol in order to prolong its half-life. Uricase rapidly reduces serum urate levels, can decrease tophus size, and can significantly reduce the urate levels (Fig. 2) [19]. The resulting allantoin does not cause adverse effects, but long-term uricase therapy can cause drug sensitization and allergic reactions, and this may be the major problem in chronic therapy.

## Perspectives

Gout is a common medical condition that is well understood in terms of physiology, but its treatment remains suboptimal in many countries. Besides treatment of the acute attack, urate-lowering therapies are important to maintain a low serum urate level in order to prevent severe complications and frequent attacks. Currently, the treatment of asymptomatic hyperuricemia is not recommended, but this recommendation may be modified in the future, as there is strong evidence linking hyperuricemia to cardiovascular and renal morbidity.

Current research topics will bring new understanding of the genetics of gout and hyperuricemia as well as the mechanisms that regulate gouty inflammation, the renal and liver urate transporters, and the biochemical interaction

between metabolic syndrome (see chapter “[Metabolic syndrome](#)”) and hyperuricemia. In addition, new XO inhibitors and IL-1 inhibitors, which are currently studied, could become future drugs for gout treatment.

## References

- Wallace KL, Riedel AA, Joseph-Ridge N, Wortmann R (2004) Increasing prevalence of gout and hyperuricemia over 10 years among older adults in a managed care population. *J Rheumatol* 31:1582–1587
- Mikuls TR, Farrar JT, Bilker WB, Fernandes S, Schumacher HR Jr, Saag KG (2005) Gout epidemiology: results from the UK General Practice Research Database, 1990–1999. *Ann Rheum Dis* 64:267–272
- Choi HK, Mount DB, Reginato AM, American College of Physicians; American Physiological Society (2005) Pathogenesis of gout. *Ann Intern Med* 143:499–516
- Choi HK, Atkinson K, Karlson EW, Willett W, Curhan G (2004) Purine-rich foods, dairy and protein intake, and the risk of gout in men. *N Engl J Med* 350:1093–1103
- Choi HK, Curhan G (2004) Beer, liquor, and wine consumption and serum uric acid level: the Third National Health and Nutrition Examination Survey. *Arthritis Rheum* 51:1023–1029
- Choi JW, Ford ES, Gao X, Choi HK (2008) Sugar-sweetened soft drinks, diet soft drinks, and serum uric acid level: the Third National Health and Nutrition Examination Survey. *Arthritis Rheum* 59:109–116
- Smyth CJ, Cotterman CW, Freyberg RH (1948) The genetics of gout and hyperuricaemia; an analysis of 19 families. *J Clin Invest* 27:749–759
- So A, Thorens B (2010) Uric acid transport and disease. *J Clin Invest* 120:1791–1799
- Martinon F (2010) Mechanisms of uric acid crystal-mediated autoinflammation. *Immunol Rev* 233:218–232
- Lu B, Nakamura T, Inouye K, Li J, Tang Y, Lundbäck P, Valdes-Ferrer SI, Olofsson PS, Kalb T, Roth J, Zou Y, Erlandsson-Harris H, Yang H, Ting JP, Wang H, Andersson U, Antoine DJ, Chavan SS, Hotamisligil GS, Tracey KJ (2012) Novel role of PKR in inflammasome activation and HMGB1 release. *Nature* 488:670–674
- Joosten LA, Netea MG, Fantuzzi G, Koenders MI, Helsen MM, Sparrer H, Pham CT, van der Meer JW, Dinarello CA, van den Berg WB (2009) Inflammatory arthritis in caspase 1 gene-deficient mice: contribution of proteinase 3 to caspase 1-independent production of bioactive interleukin-1beta. *Arthritis Rheum* 60:3651–3662
- Narayan S, Pazar B, Ea HK, Kolly L, Bagnoud N, Chobaz V, Lioté F, Vogl T, Holzinger D, Kai-Lik So

- A, Busso N (2011) Octacalcium phosphate crystals induce inflammation in vivo through interleukin-1 but independent of the NLRP3 inflammasome in mice. *Arthritis Rheum* 63:422–433
13. Schlesinger N, Alten RE, Bardin T, Schumacher HR, Bloch M, Gimona A, Krammer G, Murphy V, Richard D, So AK (2012) Canakinumab for acute gouty arthritis in patients with limited treatment options: results from two randomised, multicentre, active-controlled, double-blind trials and their initial extensions. *Ann Rheum Dis* 71:1839–1848
  14. Schlesinger N, Mysler E, Lin HY, De Meulemeester M, Rovensky J, Arulmani U, Balfour A, Krammer G, Sallstig P, So A (2011) Canakinumab reduces the risk of acute gouty arthritis flares during initiation of allopurinol treatment: results of a double-blind, randomised study. *Ann Rheum Dis* 70:1264–1271
  15. Schumacher HR Jr, Evans RR, Saag KG, Clower J, Jennings W, Weinstein SP, Yancopoulos GD, Wang J, Terkeltaub R (2012) Rilonacept (interleukin-1 trap) for prevention of gout flares during initiation of uric acid-lowering therapy: results from a phase III randomized, double-blind, placebo-controlled, confirmatory efficacy study. *Arthritis Care Res (Hoboken)* 64:1462–1470
  16. So A, De Smedt T, Revaz S, Tschopp J (2007) A pilot study of IL-1 inhibition by anakinra in acute gout. *Arthritis Res Ther* 9:R28
  17. Schumacher HR Jr, Becker MA, Wortmann RL, Macdonald PA, Hunt B, Streit J, Lademacher C, Joseph-Ridge N (2008) Effects of febuxostat versus allopurinol and placebo in reducing serum urate in subjects with hyperuricemia and gout: a 28-week, phase III, randomized, double-blind, parallel-group trial. *Arthritis Rheum* 59:1540–1548
  18. Becker MA, Schumacher HR, Espinoza LR, Wells AF, MacDonald P, Lloyd E, Lademacher C (2010) The urate-lowering efficacy and safety of febuxostat in the treatment of the hyperuricemia of gout: the CONFIRMS trial. *Arthritis Res Ther* 12:R63
  19. Ganson NJ, Kelly SJ, Scarlett E, Sundry JS, Hershfield MS (2006) Control of hyperuricemia in subjects with refractory gout, and induction of antibody against poly(ethylene glycol) (PEG), in a phase I trial of subcutaneous PEGylated urate oxidase. *Arthritis Res Ther* 8:R12



---

# Urinary Tract Infections

Matt S. Conover, Michael E. Hibbing,  
and Scott J. Hultgren

---

## Introduction to Urinary Tract Infections

Urinary tract infections (UTI), one of the most common bacterial infections, afflict 50 % of all women at least once in their lifetime with a 20–30 % chance of a recurrent infection [1]. Further, the risk of UTI is elevated in people with altered metabolism, including diabetes (see chapter “[Diabetes mellitus](#)”), obesity (see chapter “[Metabolic syndrome](#)”), and pregnancy (see chapter “[Overview](#)” under the part “Reproductive system”) [2–4]. The major etiological agent is uropathogenic *Escherichia coli* (UPEC) accounting for ~80 % of noncomplicated community-acquired UTI [1].

Three subclasses of UTI can be distinguished. Lower UTI, also known as bladder infection or cystitis, is characterized by the presence of bacteria in the urine with symptoms of frequent

painful urination and lower abdominal pain. Upper UTI or pyelonephritis (an inflammatory kidney infection) occurs when bacteria ascend to the kidney. It manifests with the additional symptoms of flank pain, pyuria (pus in the urine), and fever. Asymptomatic bacteriuria (ASB) is also frequently observed and is usually self-resolving [1].

---

## Pathophysiology of Urinary Tract Infections and Metabolic Alterations

While lower UTI represents the majority of UTIs, upper UTI can result in severe effects on host metabolism [1]. This is thought to be due to abrogation of kidney function via renal damage and scarring [5]. In response to bacterial kidney colonization, the immune system, predominantly the innate component (see chapter “[Overview](#)” under the part “[Immune system](#)”), mounts an aggressive response designed to eliminate the pathogen. This can result in significant kidney damage via reactive oxygen species and ischemia generated by a robust immune response and inflammation [6]. This damage can lead to severe metabolic complications including hypertension (see chapter “[Hypertension](#)”), uremia, and kidney failure (see chapter “[Chronic kidney disease](#)”) [5].

In the lower urinary tract, cystitis results from a toll-like receptor-mediated inflammatory response and remodeling which alters the tissue

---

M.S. Conover • M.E. Hibbing  
Department of Molecular Microbiology  
and Microbial Pathogenesis, Washington University  
in St. Louis, Saint Louis, MO 63110, USA  
e-mail: [conover@borcim.wustl.edu](mailto:conover@borcim.wustl.edu);  
[hibbing@borcim.wustl.edu](mailto:hibbing@borcim.wustl.edu)

S.J. Hultgren (✉)  
Department of Molecular Microbiology  
and Microbial Pathogenesis, Center for Women’s  
Infectious Disease Research, Washington University  
in St. Louis, 4940 Parkview Place, Room 10102,  
Saint Louis, MO 63110, USA  
e-mail: [hultgren@borcim.wustl.edu](mailto:hultgren@borcim.wustl.edu)

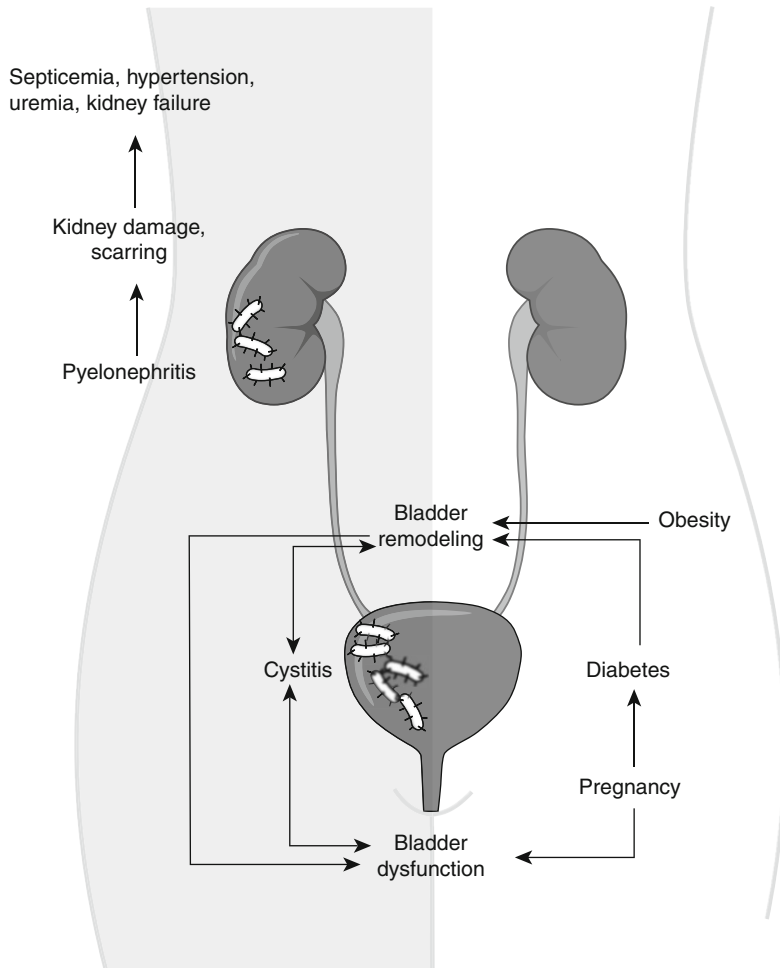

**Fig. 1** The effects of metabolism and disease on urinary tract infection (UTI). The *left side* depicts the effects and consequences of UTI on host metabolism. Cystitis in the lower urinary tract results from bacterial infection and the associated inflammatory response. This inflammation can induce damage to the bladder and urinary tract favoring remodeling processes, which in turn facilitate recurrent infection. Pylonephritis (kidney infection) is a more severe condition. Immune response causes local inflammation that increases reactive oxygen species. This, in turn, can cause kidney damage and scarring, ultimately

leading to hypertension, uremia, septicemia, and kidney failure. The *right side* displays how different metabolic states influence UTI susceptibility. Both obesity and diabetes cause bladder remodeling. Diabetes also reduces the number of leukocytes (reducing bacterial clearance) and facilitates bacterial infection (not shown). Pregnancy increases the risk of UTI via gestational diabetes and reduced bladder function. Bladder remodeling (independent of its origin) leads to bladder dysfunction, which increases the likelihood of infection in the lower urinary tract and kidney

metabolic state and can predispose the host to recurrent UTI (Fig. 1). Remodeling is due in part to the exfoliation of the bladder epithelial cells in response to bacterial invasion, altering the tissue structure and epithelial metabolism due to attempts to replace the superficial cells.

Though cystitis has not been shown to have effects on overall host metabolism, many alterations in the host metabolic state, such as obesity

and diabetes (see chapter “[Diabetes mellitus](#)”), lead to an increased susceptibility to UTIs (Fig. 1) [4]. The metabolic effects of diabetes and obesity are associated with urological conditions such as sexual dysfunction, incontinence, and UTI. Diabetics have a fourfold higher incidence of UTI, are infected with a broader range of uropathogens, and more commonly develop serious UTI sequela than nondiabetics [2].

UPEC produces hair-like fibers called type 1 pili that bind mannose residues on the urothelium, allowing for bacterial colonization and invasion into the bladder tissue [1]. Uroplakins are glycosylated proteins that help to establish an impermeable barrier on the bladder surface. This interaction is strengthened on epithelial cells from type 2 diabetes due to unknown reasons [7]. In addition, leukocyte counts are lower in the bladders of diabetics than nondiabetics, which may result in reduced clearance of bacteria in diabetics [8]. Further, diabetic bladder disorder is characterized by decreased sensation, increased capacity, and poor emptying. During diabetes, hyperglycemia-induced osmotic polyuria and the accumulation of oxidative stress products are the main factors in bladder enlargement, urothelial thickening, muscle hypertrophy, and altered urothelial cell composition, finally leading to decreased voiding and urine retention [9]. This decreased flow rate and urine turnover provide a niche for bacterial colonization.

Compared to nonpregnant women, UTI and ASB are more prevalent in pregnant females, probably due to gestational diabetes (see chapter “Diabetes mellitus”) [3, 10]. In conjunction, progesterone levels increase dramatically during pregnancy which causes decreased bladder muscle tone [11]. Less forceful voiding contractions lead to decreased shear forces in the bladder, incomplete emptying, and increased reflux to the kidneys resulting in a 25–40 % increased likelihood of kidney infection [11].

---

## Treatment of Urinary Tract Infections

The standard treatment for lower UTI involves oral antibiotics (trimethoprim/sulfamethoxazole or ciprofloxacin) to remove the infectious agent. Pyelonephritis is treated more aggressively with oral or intravenous antibiotics (cephalosporins) or a combinatorial therapy [12]. While diabetics receive similar treatment as nondiabetics, pregnant women with UTI are treated with antibiotics that carry a low risk of complications with the pregnancy (cephalexin, nitrofurantoin) [13]. ASB is usually untreated. However, in diabetics or pregnant women, antimicrobial treatment of ASB is recommended to

prevent severe sequelae [13]. Women with severe recurrent UTIs are often treated with long-term prophylactic antibiotics. In addition to antibiotics, patients may be prescribed analgesics to relieve pain. Severe cases that result in impaired kidney function may require dialysis treatments.

---

## Influence of Treatment on Metabolism

Removal of bacteria generally abrogates symptoms such as pyuria and frequency quickly. Local disturbances in the cellular environment that predispose for recurring infection take longer to normalize, such as restoration of the bladder epithelium or repair of renal scarring.

While a single course of antibiotics to clear an acute UTI has minimal impact, extended use of antibiotics, in the case of recurrent UTIs, has a dramatic effect on the composition of the gut microbiota [14]. Disturbance of this bacterial community directly influences nutrient uptake and host metabolism by altering the microflora responsible for macromolecule breakdown and absorption [15]. In addition, some antibiotics are associated with liver and kidney dysfunction disturbing normal host metabolic processes [16]. This is hypothesized to be due to tissue stress, interruption of metabolite transport, and accumulation of toxic intermediates.

---

## Perspectives

As the western lifestyle increasingly leads to obesity and associated metabolic syndrome, the incidence of UTI will continue to rise. Concurrently, antibiotic resistance is proliferating among uropathogens including the emergence of multidrug-resistant UPEC [1]. To combat this rise of antibiotic resistance, new therapies and preventative measures are being developed such as the mannoside class of anti-virulence compounds. These act as high-affinity-binding antagonists to block type 1 pilus-mediated UPEC attachment to the urothelium [17]. Similarly, small-molecule compounds, which inhibit pilus biogenesis, are being examined as a possible anti-virulence UTI treatment.

In addition, several vaccines are undergoing clinical trials targeting bacterial virulence factors or whole uropathogens [17].

## References

- Hannan TJ, Totsika M, Mansfield KJ, Moore KH, Schembri MA, Hultgren SJ (2012) Host-pathogen checkpoints and population bottlenecks in persistent and intracellular uropathogenic *Escherichia coli* bladder infection. *FEMS Microbiol Rev* 36:616–648
- Boyko EJ, Fihn SD, Scholes D, Abraham L, Monsey B (2005) Risk of urinary tract infection and asymptomatic bacteriuria among diabetic and nondiabetic postmenopausal women. *Am J Epidemiol* 161:557–564
- Delzell JE Jr, Lefevre ML (2000) Urinary tract infections during pregnancy. *Am Fam Physician* 61:713–721
- Semins MJ, Shore AD, Makary MA, Weiner J, Matlaga BR (2012) The impact of obesity on urinary tract infection risk. *Urology* 79:266–269
- Pohl HG, Sedberry-Ross S, Rushton G (2011) Urinary tract infections. In: Palmer JS (ed) *Pediatric urology*. Humana Press, New York, pp 37–69
- Svensson M, Yadav M, Holmqvist B, Lutay N, Svanborg C, Godaly G (2011) Acute pyelonephritis and renal scarring are caused by dysfunctional innate immunity in mCxcr2 heterozygous mice. *Kidney Int* 80:1064–1072
- Geerlings SE, Stolk RP, Camps MJ, Netten PM, Collet TJ, Hoepelman AI (2000) Risk factors for symptomatic urinary tract infection in women with diabetes. *Diabetes Care* 23:1737–1741
- Geerlings SE (2008) Urinary tract infections in patients with diabetes mellitus: epidemiology, pathogenesis and treatment. *Int J Antimicrob Agents* 31(Suppl 1):S54–S57
- Cai H, Dikalov S, Griendling KK, Harrison DG (2007) Detection of reactive oxygen species and nitric oxide in vascular cells and tissues: comparison of sensitivity and specificity. *Methods Mol Med* 139:293–311
- Lain KY, Catalano PM (2007) Metabolic changes in pregnancy. *Clin Obstet Gynecol* 50:938–948
- Dielubanza EJ, Schaeffer AJ (2011) Urinary tract infections in women. *Med Clin North Am* 95:27–41
- Naber KG, Wullt B, Wagenlehner FM (2011) Antibiotic treatment of uncomplicated urinary tract infection in premenopausal women. *Int J Antimicrob Agents* 38(Suppl):21–35
- Guinto VT, De Guia B, Festin MR, Dowswell T (2010) Different antibiotic regimens for treating asymptomatic bacteriuria in pregnancy. *Cochrane Database Syst Rev* (9):CD007855
- Cotter PD, Stanton C, Ross RP, Hill C (2012) The impact of antibiotics on the gut microbiota as revealed by high throughput DNA sequencing. *Discov Med* 13:193–199
- Tremaroli V, Backhed F (2012) Functional interactions between the gut microbiota and host metabolism. *Nature* 489:242–249
- Wawruch M, Bozekova L, Krcmery S, Kriska M (2002) Risks of antibiotic treatment. *Bratisl Lek Listy* 103:270–275
- Barber AE, Norton JP, Spivak AM, Mulvey MA (2013) Urinary tract infections: current and emerging management strategies. *Clin Infect Dis* 57:719–724

---

# Kidney Stones

Andreas Neisius and Glenn M. Preminger

---

## Introduction to Kidney Stones

Urinary stone disease is characterized by crystalline depositions (called calculi) in the renal calyces, pelvis, or ureter, which are classified due to their location and chemical composition. About 80 % of urinary stones are calcium oxalate stones with a variable amount of calcium phosphate. Less than 20 % of stones are non-calcium calculi composed out of uric acid, magnesium ammonium phosphate (struvite), or cysteine (two cysteines linked by a disulfide bond).

Stone disease (ureterolithiasis) occurs with an increasing prevalence in the population of industrialized countries, currently ~9 % in the United States (compared with only ~5 % in 1994) [1], causing a significant health-care burden in the working-age population. The prevalence is higher for men (with ~11 %) than for women (with ~7 %). After a first calcium stone, the risk

of recurrence is 40 % at 5 years and 75 % at 20 years. Recently, incidence of stone disease has been correlated to the “metabolic syndrome” (see chapter “[Metabolic syndrome](#)”) [2]. Recognized risk factors are determined by various metabolic and environmental factors (Fig. 1), but some are related to genetics. These factors have to be analyzed individually depending on stone analysis and 24-h urine profiles.

In this chapter, we will provide a brief review of the pathophysiology of stone disease, its metabolic evaluation, and selective medical treatment, which is highly effective in preventing new stone formation, thereby reducing the need for repeated invasive procedures in patients predisposed to nephrolithiasis.

---

## Pathophysiology of Kidney Stones and Metabolic Alterations

### Epidemiology and Evaluation of Nephrolithiasis

The urinary environment of stone patients is conducive to the crystallization of stone-forming salts, due to increased supersaturation and/or reduced inhibitor activity. A metabolic or environmental etiology (i.e., dietary habits) can be found in ~97 % of stone disease patients [3]; genetic reasons are rare and include cystinuria [4] and primary hyperoxaluria.

Environmental triggers for stone formation include low urinary volume, low urinary  $Mg^{2+}$ ,

---

A. Neisius  
Department of Urology, Universitätsmedizin  
der Johannes-Gutenberg Universität,  
Langenbeckstrasse 1, Mainz 55131, Germany

Division of Urologic Surgery, Department of Urology,  
Comprehensive Kidney Stone Center,  
Duke University Medical Center, Room 1572D,  
White Zone, 3167, Durham, NC 27710, USA  
e-mail: [andreas.neisius@unimedizin-mainz.de](mailto:andreas.neisius@unimedizin-mainz.de)

G.M. Preminger (✉)  
Department of Urology, Universitätsmedizin  
der Johannes-Gutenberg Universität,  
Langenbeckstrasse 1, Mainz 55131, Germany  
e-mail: [glenn.preminger@duke.edu](mailto:glenn.preminger@duke.edu)

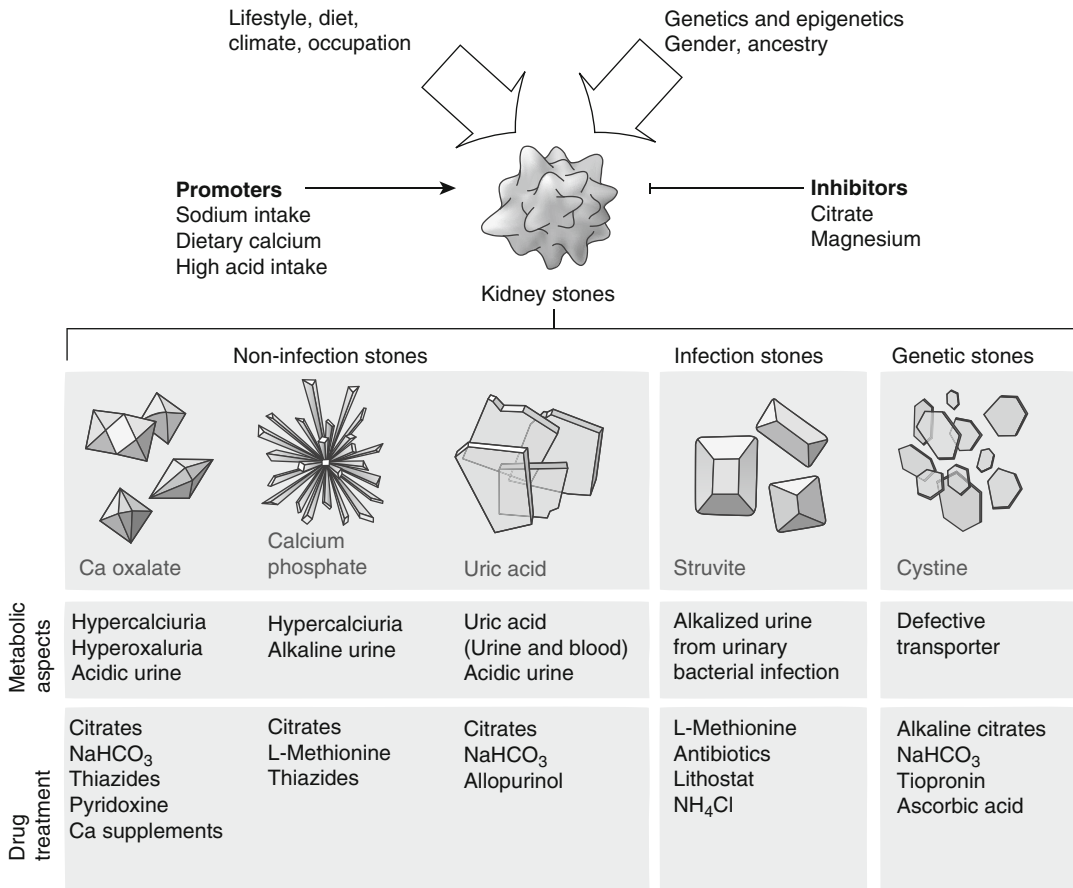

**Fig. 1** Factors influencing formation of different stone types, their pathogenesis, and therapy. Risk factors for stone disease generally include lifestyle and genetic/epigenetic contributions. Formation of kidney stones is modulated by promoting or inhibiting metabolic factors (mainly concerning ion composition). Kidney stones can

show different structures and, more importantly, chemical composition and are grouped into noninfectious, infectious, and genetic stones. Causes and/or diagnostic markers for the important subgroups are shown, as well as the most common treatment. General promoters and inhibitors are mentioned

and high urinary Na<sup>+</sup>, sulfate, and phosphate (P<sub>i</sub>), due to dietary intake. Metabolic risk factors include high urinary Ca<sup>2+</sup> (idiopathic hypercalciuria) [5], oxalate (hyperoxaluria), and uric acid (hyperuricosuria), low urinary citrate (hypocitraturia), and abnormally high or low pH (as in gouty diathesis). Decreased urinary volume and/or increase in ions that can participate in stone formation (Ca<sup>2+</sup>, oxalate, Na<sup>+</sup>, sulfate, P<sub>i</sub>) can cause supersaturation and crystallization. Citrate is a crystallization inhibitor and builds

complexes with Ca<sup>2+</sup> ions, thus inhibiting Ca<sup>2+</sup> stone formation.

Critical care must be taken to the underlying mechanism, when evaluating high-risk patients including children, middle-aged white males with a family history of stones, and patients with chronic diarrheal or GI malabsorptive states, bone disease (see chapters “[Overview](#)” under the part “[Teeth and bones](#)” and “[Osteoporosis](#)”), urinary tract infection (see chapter “[Urinary tract infections](#)”), gout (see chapter “[Gout and](#)

hyperuricemia”), or nephrocalcinosis. They should undergo an extensive evaluation if they are first-time stone formers. Any patient with cystine, uric acid, or struvite stones should undergo a complete metabolic workup. Routine blood work can suggest primary hyperparathyroidism, distal renal tubular acidosis, and urinary tract infections (see chapter “[Urinary tract infections](#)”).

Imaging studies (abdominal X-ray, ultrasound, or computer tomography) are suggested as the first-line diagnostic tool to assess current stone burden, with a low-dose non-contrast computer tomography scan as gold standard [6]. Secondly, stones should be analyzed to discriminate the chemical class and underlying mechanism (Fig. 1). Urine pH should be determined as a pH above 7.5 suggests infection stones (of struvite (magnesium ammonium phosphate) or carbon apatite) and a pH below 5.5 indicates possible uric acid stones. Urine sediment should be examined for crystals and urine cultures should be taken, since infection with urea-splitting organisms will promote struvite stones. Cystinuria can be proven with a nitroprusside test, in which cystines are first cleaved into cysteines, which subsequently react with cyanides in nitroprusside to form a colored product indicating the presence of cystine. Hydroxyapatite (calcium phosphate) crystals are often formed due to primary hyperparathyroidism, as parathyroid hormone (PTH) releases  $\text{Ca}^{2+}$  from the bones to increase blood  $\text{Ca}^{2+}$  levels (see chapter “[Overview](#)” under the part “[Teeth and bones](#)”), which leads to calcium phosphate stones and osteoporosis (see chapter “[Osteoporosis](#)”). Renal tubular acidosis and uric acid stones suggest gouty diathesis or any other causes of purine overproduction and vice versa (see chapter “[Gout and hyperuricemia](#)”). Calcium oxalate or mixed hydroxyapatite and calcium oxalate calculi can occur in a various number of conditions.

Around 80–90 % of oxalate is synthesized in the liver; the remainder comes from dietary oxalate or vitamin C ingestion (ascorbic acid). Metabolic

or environmental increase in oxalate quickly leads to supersaturation of oxalate in the blood, which causes calcium oxalate crystallization. Hyperoxaluria can be caused by increased oxalate synthesis and excessive vitamin C (>2,000 mg/day) or oxalate-rich food ingestion [7]. In clinical practice, the main cause of hyperoxaluria is bowel disease/surgery (enteric hyperoxaluria).

---

## Treatment of Kidney Stones

### General Points

Crystallized calculi are very difficult to solubilize, even if urine concentrations of the causing substances are normalized. As such, surgical intervention (i.e., via an endourological approach called ureterorenoscopy or a percutaneous approach called percutaneous nephrolithotomy) is still the mainstay in the treatment of nephrolithiasis. Dependent on localization and stone size, extracorporeal shockwave lithotripsy depicts an equally successful therapy modality. However, as recurrence is high, the following medical treatment options aim to prevent reformation or growth of new calculi.

As urinary crystals emerge by supersaturation of the causing substance, decreasing concentration is generally helpful. Most importantly, low urine volume must be corrected (output >2 l/day), conservatively by increased fluid intake [8]. It has been demonstrated that single-stone formers treated conservatively, with avoidance of dietary excess and increased fluid intake, have low incidence of recurrent stone disease [8]. In addition, all patients are counseled to moderate their intake of high  $\text{Na}^+$  (as this causes higher  $\text{Ca}^{2+}$  excretion in the kidney, see chapters “[Overview](#)” under the part “[Kidney](#)” and “[Chronic kidney disease](#)”) and oxalate-containing foods, such as rhubarb, spinach, and red beet.

Medical therapy is initialized once dietary restriction and fluid increase are not sufficient. Medical treatment is directed at the underlying



disease, environmental or metabolic state of the respective stone class. Specific treatments for the respective stone classes are discussed in the next section.

---

## **Influence of Treatment on Metabolism and Consequences for Patients**

### **Treatment of Calcium Stones due to Hypercalciuria**

Thiazide diuretics are the recommended medications for hypercalciuria as they limit urinary  $\text{Ca}^{2+}$  excretion, decreasing formation of Ca-containing stones. Thiazides inhibit the  $\text{Na}^+\text{-Cl}^-$  symporter. This decreases the  $\text{Na}^+$  levels in renal tubular cells, activating the basolateral  $\text{Na}^+/\text{Ca}^{2+}\text{-ATPase}$  antiporter. The subsequent reduction of  $\text{Ca}^{2+}$  in the cell increases reabsorption from the tubule. However, thiazides can cause (secondary) hypokalemia and hypocitraturia (via similar mechanisms). Thus, potassium citrate is typically administered as adjunctive.

### **Treatment of Oxalate Stones due to Hyperoxaluria or Enteric Hyperoxaluria**

A general strategy to prevent formation of oxalate stones is dietary reduction of oxalate (see above). Patients with intestinal malabsorption of fat, as seen in patients with Crohn's disease, often present with increased levels of oxalate in blood and urine after intestinal resection or jejunioileal bypass (enteric hyperoxaluria). The loss of fatty acids is combined with loss of  $\text{Ca}^{2+}$ , which disturbs the normal complex formation between oxalate and calcium in the bowel, thereby increasing oxalate absorption. Oral administration of  $\text{Ca}^{2+}$  supplements [9] has been recommended, to enable calcium oxalate complexation in the intestine. Pyridoxine (vitamin B6) can also be used to reduce the urine oxalate by reducing the primary oxalate synthesis in the liver [10], as many patients with

Crohn's disease need to avoid  $\text{Ca}^{2+}$  products due to their intolerance to any calcium-containing products.

### **Treatment of Calcium-Containing Stones due to Hypocitraturia**

By forming a more soluble calcium-citrate complex, citrate decreases the effective concentration of free  $\text{Ca}^{2+}$  and thus urinary saturation of calcium oxalate. Hypocitraturia often coexists with hypercalciuria or hyperuricosuria. Thus, potassium citrate is an efficient and safe treatment for hypocitraturia [11].

### **Treatment of Uric Acid-Containing Stones due to Hyperuricemia/Gouty Diathesis**

As the primary cause of uric acid stones is an excessively increased uric acid level in the blood and (acid) urine ( $\text{pH} < 5.5$ ), correction of both is aspired. The major goal is to decrease urinary saturation of uric acid by raising the urine pH to 6.5–7.0, by increasing urine volume, and by providing alkali therapy. As the solubility for uric acid increases tenfold with a pH change from 5.0 to 7.0, urinary alkalization is by far the most important factor. Therefore, citrate (or sodium bicarbonate) is appropriate, as these salts will alkalize the urine. Moreover, allopurinol and a diet poor in purines are recommended to lower total endogenous uric acid (see chapter “Gout and hyperuricemia”).

### **Treatment of Distal Renal Tubular Acidosis**

The metabolic acidosis and hypokalemia found in patients with distal renal tubular acidosis can be corrected with potassium citrate, as citrate is (in part) metabolized to bicarbonate. Normal urine citrate concentrations can be achieved. Correction of the acidosis should lead to a decline in the urinary  $\text{Ca}^{2+}$  excretion [12].



## Treatment of Struvite Stones due to Infection

Struvite stones occur in the setting of urinary tract infections (see chapter “[Urinary tract infections](#)”). Some bacteria contain urease, splitting urea into carbon dioxide and ammonia, thus increasing the urinary pH [13]. Again, higher fluid intake and purine-poor diet prevent crystal formation as they can reduce the concentration of the critical agents below the threshold. Antibiotic treatment and surgical stone removal are commonly required, supported by urinary acidification using L-methionine or ammonium chloride and urease inhibition, e.g., via acetohydroxamic acid (Lithostat).

## Treatment of Cystine Stones due to Cystinuria

The main therapeutic option for avoiding cystine crystallization is reduction of cystine excretion and increasing urinary volume. Tiopronin ( $\alpha$ -mercaptopyrionylglycine) builds disulfides with cysteine, similar to cystine (chelating agent). As this disulfide has a higher solubility than cysteine, it reduces the availability of cysteine for cystine formation. However, tiopronin shows extensive side effects such as nephritic syndrome.

Ascorbic acid is recommended when cystine excretion is  $<3.0$  mmol/day; the same threshold is known for the supportive treatment with potassium citrate [9].

## Perspectives

Recurrence rates for stone formers can be high. Even though surgical or interventional therapy is the standard to treat existing stones, medical therapy is an essential adjunct to manage primary and especially recurrent stone disease. The need for repetitive surgical procedures can be significantly

reduced by an effective prophylactic program. Current research trends aim on understanding epidemiological factors and dietary behavior to avoid stone.

## References

1. Scales CD Jr, Smith AC, Hanley JM, Saigal CS (2012) Prevalence of kidney stones in the United States. *Eur Urol* 62:160–165
2. Taylor EN, Stampfer MJ, Curhan GC (2005) Obesity, weight gain, and the risk of kidney stones. *JAMA* 293:455–462
3. Delvecchio FC, Preminger GM (2003) Medical management of stone disease. *Curr Opin Urol* 13:229–233
4. Pak CY, Fuller CJ (1983) Assessment of cystine solubility in urine and of heterogeneous nucleation. *J Urol* 129:1066–1070
5. Coe FL, Parks JH, Moore ES (1979) Familial idiopathic hypercalciuria. *N Engl J Med* 300:337–340
6. Niemann T, Kollmann T, Bongartz G (2008) Diagnostic performance of low-dose CT for the detection of urolithiasis: a meta-analysis. *AJR Am J Roentgenol* 191:396–401
7. Smith LH, Fromm H, Hofmann AF (1972) Acquired hyperoxaluria, nephrolithiasis, and intestinal disease. Description of a syndrome. *N Engl J Med* 286:1371–1375
8. Hosking DH, Erickson SB, Van den Berg CJ, Wilson DM, Smith LH (1983) The stone clinic effect in patients with idiopathic calcium urolithiasis. *J Urol* 130:1115–1118
9. Türk CK, Knoll T, Petrik A, Sarica K, Straub M, Seitz C (2012) Guidelines on urolithiasis. Available from: [http://www.uroweb.org/gls/pdf/20\\_Urolithiasis\\_LR%20March%2013%202012.pdf](http://www.uroweb.org/gls/pdf/20_Urolithiasis_LR%20March%2013%202012.pdf). Accessed on 21 Aug 2013
10. Duffey BG, Alanee S, Pedro RN, Hinck B, Kriedberg C, Ikramuddin S, Kellogg T, Stessman M, Moeding A, Monga M (2010) Hyperoxaluria is a long-term consequence of Roux-en-Y Gastric bypass: a 2-year prospective longitudinal study. *J Am Coll Surg* 211:8–15
11. Pak CY, Fuller C (1986) Idiopathic hypocitraturic calcium-oxalate nephrolithiasis successfully treated with potassium citrate. *Ann Intern Med* 104:33–37
12. Preminger GM, Sakhaee K, Skurla C, Pak CY (1985) Prevention of recurrent calcium stone formation with potassium citrate therapy in patients with distal renal tubular acidosis. *J Urol* 134:20–23
13. Griffith DP, Musher DM (1973) Prevention of infected urinary stones by urease inhibition. *Invest Urol* 11:228–233

---

**Part XV**

**Reproductive System**

---

## Overview

Danny J. Schust and Donald R. Gullicks

---

### Anatomy and Physiology of the Reproductive System

The gonads are the end organs of reproduction, represented by the ovary in women and the testis in men (Fig. 1). They produce and release germ cells, central to the survival of the species. Ovaries contain all the oocytes they will ever have at birth, although they will not begin to be released until puberty. The testis can produce sperm from the age of puberty until death. Besides the formation of germ cells, testes and ovaries produce sex hormones that affect the physiology of many, if not all nonreproductive organs. The steroid hormone-producing cells of the ovary are the theca and granulosa cells of the ovarian follicle; those of the testis are the Sertoli and Leydig cells. The function of the gonads is mainly regulated by the hypothalamus-pituitary axis (Fig. 1). The human breast is a secondary reproductive organ that serves to feed the infant in the first period of life.

---

D.J. Schust (✉)

Department of Obstetrics, Gynecology and Women's Health, University of Missouri School of Medicine, 500 North Keene Street, Suite 203, Columbia, MO 65201, USA  
e-mail: [schustd@health.missouri.edu](mailto:schustd@health.missouri.edu)

D.R. Gullicks

Department of Obstetrics, Gynecology and Women's Health, University of Missouri School of Medicine, 402 North Keene Street, Third floor, Columbia, MO 65212, USA  
e-mail: [gullicksr@health.missouri.edu](mailto:gullicksr@health.missouri.edu)

---

### Reproductive Organ-Specific Metabolic Pathways

Steroids are produced by several tissues, including the adrenal cortex, the gonads, the placenta, and the peripheral tissues such as the adipose tissue and the brain. All steroid hormones are derivatives of cholesterol, and production of sex steroids requires the expression of enzymes within the steroidogenic pathway (Fig. 1) [1].

The testis mainly produces androgens, such as androstenediol, androstenedione, testosterone, dihydrotestosterone, and small amounts of dehydroepiandrosterone (DHEA), released from the Leydig cells, whereas the Sertoli cells in the testis convert testosterone to small amounts of estrogen, such as estradiol (E2), required for spermatogenesis. Estrogens in men are produced at a much lower rate than in women.

The ovaries produce estrogens, such as estrone (E1) and E2; progesterones, i.e., progesterone (P4) and 17 $\alpha$ -hydroxy-progesterone; and androgens (similar to the testis, except for dihydrotestosterone). Androgen production in women is much lower than in men. For example, levels of circulating testosterone in women are about 1/8th that of men. DHEA is found in fairly high concentrations in the circulation of women, mostly in its sulfated form: DHEA-S. Sulfation of DHEA occurs in the adrenals, the liver, and the intestine. The major function of DHEA is that of a precursor to other androgens and estrogens (Fig. 1). The weak estrogen, estriol (E3), is produced only during pregnancy, by the placenta.

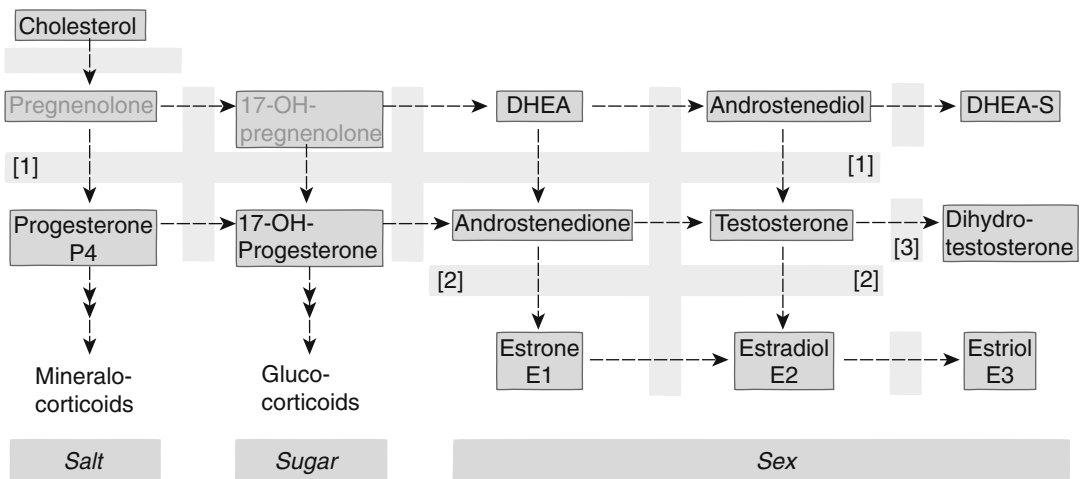
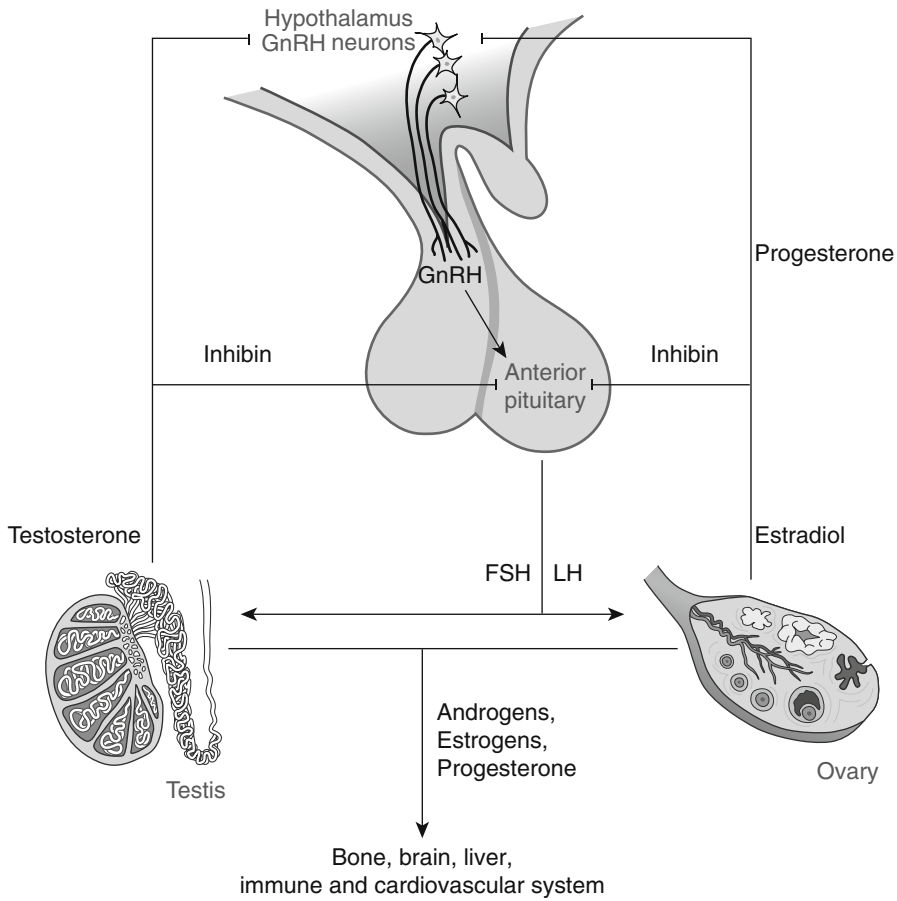

**Fig. 1** Production pathways of sex steroids and the hypothalamic-pituitary-gonadal axis. *Upper part*: regulation of sex steroid production by the hypothalamus-pituitary axis and feedback mechanisms. *GnRH* gonadotropin-releasing hormone, *FSH* follicle-stimulating hormone, *LH* luteinizing hormone. *Lower part*: steroid hormone biosynthesis

showing important intermediates and enzymes. *Gray boxes* indicate enzymes. [1] 3β-OH dehydrogenase: 5 4 isomerase, [2] aromatase, [3] 5α-reductase. Further, enzymes and molecules in Light gray are not mentioned in the text but included for completeness. *DHEA* dehydroepiandrosterone

The adrenal gland generally produces sex steroids as byproducts of gluco- and mineralocorticoids and therefore in fairly small amounts when compared to the gonads. One important physiologic exception is that approximately half of the circulating androgens in women are of adrenal origin.

---

### **Inside-In: Signals in the Reproductive Organs**

Development and release of each type of germ cell require delicately balanced interactions between several gonad-specific cell types (testicular Sertoli and Leydig cells in men and ovarian granulosa and theca cells in women) and the sex steroids produced by these cells.

Theca cells surrounding the ovarian follicle produce androgens, which are converted to estrogens by the granulosa cells of the ovarian follicle. Ovarian E2 and its feedback interactions with the hypothalamus and pituitary gland direct the development of the ovarian follicle. Peptide hormones produced by the ovary (e.g., inhibin, activin, and follistatin) also participate in positive and negative regulation of the hypothalamic-pituitary-gonadal axis and function in controlling menstrual cyclicity.

Testicular androgens are mostly produced by the Leydig cells under the influence of pituitary luteinizing hormone (LH). The Sertoli cells of the testis support sperm proliferation and maturation and can convert androgens to estrogens via aromatase or to dihydrotestosterone via 5 $\alpha$ -reductase (Fig. 1). They also secrete inhibin to regulate LH release (Fig. 1 and below). Most dihydrotestosterone, however, is synthesized locally in androgen-responsive tissues (such as hair follicle cells).

---

### **Outside-In: Hypothalamus/Pituitary/Reproductive Organ Axis**

The major organ controlling the gonads is the pituitary gland, which itself is (primarily) controlled by the hypothalamus. The pituitary is

composed of three parts: the anterior lobe, the posterior lobe, and the pars intermedia (Fig. 1) [2]. Three specific cell types within the anterior pituitary play a central role in reproduction (see below).

The hypothalamus is divided into nuclei, which generate neural signals and have neuroendocrine capabilities. Most centrally involved in gonad regulation are those nuclei that integrate olfactory, visual, emotional, and other signals [3]. The neuroendocrine signals consist of a set of peptide hormones that either are stored in the posterior pituitary and then released into the blood or target the anterior lobe of the pituitary (Fig. 1). The latter substances stimulate or inhibit the production of tropic hormones. These hormones are commonly named according to their function as “releasing” and “stimulating” hormones, respectively.

### **Signals from the Hypothalamus**

Oxytocin and vasopressin (also known as antidiuretic hormone, ADH) are synthesized by the hypothalamus and stored in the posterior pituitary. Oxytocin acts on uterine smooth muscle resulting in contractions and affects specialized myoepithelial cells in the breast allowing for milk letdown.

Gonadotropin-releasing hormone (GnRH) is released in a pulsatile fashion from the hypothalamus and stimulates gonadotropic cells in the anterior pituitary to produce follicle-stimulating hormone (FSH) and LH. These gonadotropins are secreted by the same cell type, and their secretion is modulated by the frequency of the GnRH pulse, with higher frequency favoring LH over FSH and a lower frequency favoring FSH over LH.

Dopamine from the hypothalamus, also called prolactin inhibitory factor, suppresses prolactin production by lactotrope cells in the pituitary. Pituitary lactotropes are also regulated by a number of other factors (see below).

The third pituitary cell type involved in gonad regulation, the thyrotropes, produces thyroid-stimulating hormone (TSH), triggered by

thyrotropin-releasing hormone from the hypothalamus.

### Signals from the Pituitary Gland

FSH and LH from the pituitary act on the ovaries to control the menstrual cycle. FSH induces ovarian granulosa cell proliferation and aromatase activity to allow production of E2. As E2 increases, FSH stimulates increased LH responsiveness. E2 and inhibin suppress FSH production at the level of the hypothalamus and pituitary (Fig. 1), but prolonged elevated E2 levels cause a surge in LH [4]. This, in turn, results in release of a selected oocyte from the ovary (ovulation) and transformation of granulosa cells into the secretory luteinized cells of the corpus luteum. Luteal cells make large amounts of P4, but also E2 and inhibin. Increased P4 levels prevent E2 from stimulating another LH surge, and high E2 and P4 reduce the frequency of the GnRH pulse favoring LH over FSH secretion. If pregnancy does not occur, these LH levels are not, however, sufficient to support the corpus luteum (for very long). As P4, E2, and inhibin levels drop, FSH levels rise. Menstruation begins and the cycle repeats. In case of a pregnancy, luteal P4 supports the pregnancy until hormonal support is taken over by the placenta (typically 7–9 weeks of gestation). The cyclic production of ovarian E2 and P4 directs the growth and differentiation of the uterine endometrium to prepare it for embryo implantation.

FSH and LH are similarly important in the regulation of the testis. FSH and LH increase the proliferation of Leydig cells, and LH upregulates 3 $\beta$ -hydroxysteroid dehydrogenase, which is responsible for the last step in testosterone formation (Fig. 1) [5].

Prolactin controls the initiation of lactation. In contrast to other pituitary hormones, it is not negatively regulated by classic feedback loops but rather by local autocrine and paracrine factors, neurotransmitters, and by peripherally produced steroid hormones. Ovarian E2 and pituitary TRH are strong stimuli for prolactin production.

Growth hormone (GH), insulin-like growth factors (IGFs), IGF-binding proteins (IGFBPs),

and IGF receptors of the somatotrophic axis enhance ovarian steroidogenesis.

### Inside-Out: Signals from Reproductive Organs Affecting Other Organs

The sex steroids result in several gender-specific health risks. The local and peripheral effects of steroid hormones depend on the presence of specific steroid hormone receptors in target tissues. These receptors are generally present in the cytoplasm or nucleus of the target cell and are expressed throughout the body. Upon ligand binding, steroid-receptor complexes commonly act as transcription factors by targeting steroid response elements that, in turn, regulate the expression of a remarkably wide variety of genes.

The presence of 5 $\alpha$ -reductase in peripheral tissues allows for the local conversion of testosterone to the more potent dihydrotestosterone (DHT). While locally elevated testosterone levels direct the development of the male internal reproductive structures during fetal development, DHT directs appropriate development of the penis and scrotum in the fetus and masculinization at puberty in boys (increased penile length, testicular size, and growth of axillary, pubic, chest, abdominal, and facial hair). Estrogens and P4 have little effect on the development of female internal or external genitalia during fetal development, but they are essential to pubertal development (breast and bone growth) and the onset of menstruation. Excesses in circulating androgens act on hair follicles and may lead to hirsutism and acne in women.

As a multitude of targets exist, female steroid hormone excess and deficiency, as they occur during pregnancy and menopause, respectively, or in pathological states, affect a vast array of tissue types (Fig. 2).

### Pregnancy

Marked increases in circulating ovarian E1, E2, and P4 and placental estriol and P4 during

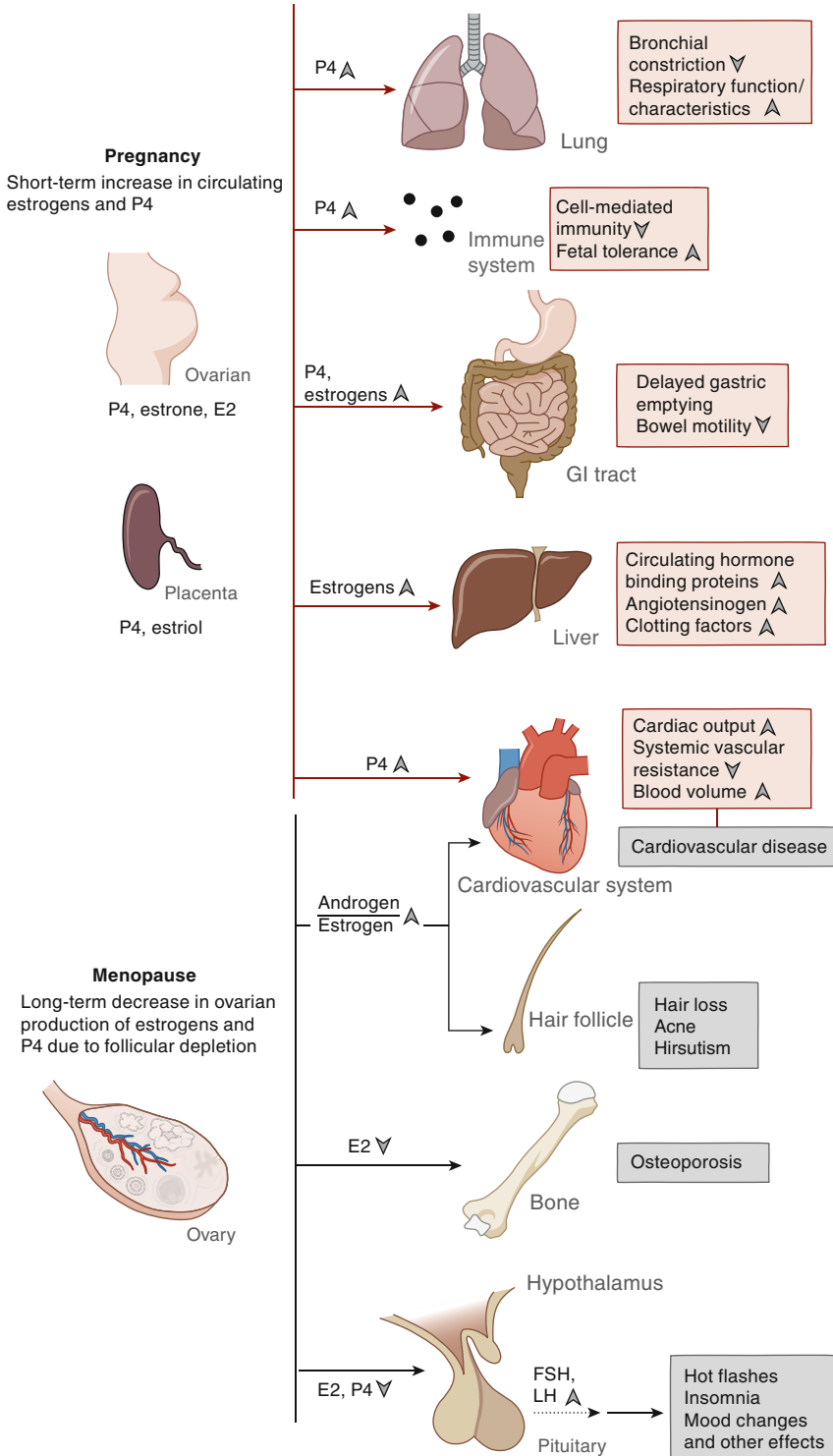

**Fig. 2** Effects of female steroid hormones (exemplified by changes in these hormones during pregnancy and menopause) P4 progesterone, E2 estradiol

pregnancy dominate the systemic steroid effectors in maternal blood. Estrogens and P4 increase maternal blood volume and cardiac output to supply the developing fetus with blood while maintaining or lowering maternal blood pressure. E1, E2, and E3 can all exert these effects via estrogen receptor binding; however, E3 comprises approximately 80 % of circulating maternal estrogens during pregnancy and therefore may exert the most significant effects. Elevated placental estrogens increase the production of angiotensinogen (by the liver), and estrogens and P4 increase renin (from the kidney), thus increasing the level of angiotensin and subsequently aldosterone, which, in turn, promotes sodium and water retention (see chapter “[Overview](#)” under the part “[Kidney](#)”). Although the maintenance of maternal blood pressure in the face of increased blood volume is largely the result of the lower maternal responsiveness to angiotensin II during pregnancy, the elevated levels of circulating P4 accentuate this adaptation by mediating smooth muscle relaxation throughout the mother’s body. This latter effect of P4 also results in delayed gastric and gallbladder emptying, reduced bowel motility, and relaxation of the lower esophageal sphincter in the pregnant women, often experienced by the mother as reflux, nausea, vomiting, and/or constipation.

P4-related bronchial and tracheal smooth muscle relaxation may improve asthma symptoms (see chapter “[Asthma](#)”) in pregnancy. Other respiratory effects of elevated maternal P4 include an increase in tidal volume (lung volume), minute ventilation (the volume of gas inhaled or exhaled per minute), and respiratory rate (breathing frequency), resulting in an overall decrease in arterial CO<sub>2</sub> gas tension via central nervous system changes that increase sensitivity to CO<sub>2</sub> [6].

Estrogens upregulate hepatic synthesis of hormone-binding proteins and several clotting factors promoting hypercoagulability and an increase in total circulating thyroid hormones. P4 and estrogens exert effects on maternal immune function causing susceptibility to certain viral infections (e.g., varicella) but allowing tolerance against the semi-allogenic fetus. Pregnant women with antibody-mediated autoimmune diseases

often note an exacerbation of symptoms, while those with T-cell-based inflammatory conditions may experience improvement [7]. Interestingly, immune effects of P4 in pregnancy are thought to be mediated through the glucocorticoid receptor or through nonclassical P4 receptors (as classical are not expressed on most immune cells) [8].

## Menopause

At menopause, there is a cessation of ovarian follicular development with resultant marked decreases in circulating estrogen, inhibin, and P4 levels. Ovarian androgen production remains relatively intact. This relative hormone deficiency has several physiologic effects. Decreased estrogen and inhibin release the negative feedback on the hypothalamus and pituitary gland (Fig. 1), and consequently FSH levels rise. Alterations in these hormones have been linked to the hot flashes, insomnia, and depressed mood that are commonly found in peri- and early postmenopausal women. Estrogen deficiency leads to tissue atrophy and loss of elasticity in the breast, vagina, and skin. As estrogen antagonizes the effects of parathyroid hormone on Ca<sup>2+</sup> mobilization in bone (see chapter “[Overview](#)” under the part “[Teeth and bones](#)”), and since estrogen deficiency increases osteoclast activity, postmenopausal women are at increased risk for osteoporosis (see chapter “[Osteoporosis](#)”).

Estrogen increases circulating high-density lipoproteins and decreases low-density lipoproteins (see chapter “[Hyperlipidemia](#)”). Moreover, it decreases endothelial production of endothelin-1, a potent vasoconstrictor (see chapter “[Overview](#)” under the part “[Blood vessels](#)”). These two protective cardiovascular effects of estrogens may help to explain the lower rates of cardiovascular disease (see chapter “[Atherosclerotic heart disease](#)”) seen in women compared to men. Reduced estrogens, in combination with a relatively intact androgen production, cause a gradual loss of this protection after menopause. Interestingly, androgens are converted to dihydrotestosterone in hair follicles (see above), and continued production of this potent androgen often results in hirsutism and some



degree of hair loss on the scalp of postmenopausal women. Adipose tissue is an important source of the enzyme aromatase that converts androgens to estrogen. Obesity can therefore increase levels of circulating estrogens in postmenopausal women, somewhat protecting these women from the effects of decreased ovarian estrogens.

Male reproductive hormones have equally dramatic effects on the vast array of tissues that express androgen receptors. For example, androgen receptors are expressed in skeletal muscle, and their activation stimulates the myogenesis responsible for the increased muscle mass noted in the postpubertal men compared to women [9]. The elevated levels of circulating androgens in men combine with genetic predisposition to make baldness much more common in men than in women (see above). Androgens increase bone mass through receptor-mediated direct and indirect effects on osteoclasts. Their effects on cardiovascular disease are complex, but androgens certainly promote less favorable lipid profiles by increasing LDL and triglyceride levels and decreasing HDL levels (see chapter “[Hyperlipidemia](#)”) [10]. The prostate gland is unique among the male internal reproductive tract constituents in that dihydrotestosterone, rather than testosterone, is required for its development, growth, and maintenance. The nuclear androgen receptors in the prostate have a higher affinity for dihydrotestosterone, so adequate 5 $\alpha$ -reductase activities are essential for prostate growth. Men lacking this enzyme have a poorly developed prostate gland and essentially no risk for subsequent prostate hypertrophy or prostate cancer (see chapter “[Prostate cancer](#)”). Like women, men experience reproductive aging, termed andropause, although its onset and progression is less predictable and more gradual. Circulating testosterone levels decrease, thus causing osteopenia and osteoporosis (see chapter “[Osteoporosis](#)”), decreased muscle mass, erectile dysfunction, and impaired sperm parameters [11]. Testicular Leydig cells also become less responsive to LH with aging. In response, LH levels increase to maintain androgen production (see above) but also increase the ratio of testicular estrogen to androgen secretion.

Additionally, as aging males tend to be overweight, circulating E2 levels are often increased. Estrogen-stimulated increases in hepatic sex hormone-binding globulin production effectively decrease levels of circulating free testosterone in the aging male.

---

## **Anatomy and Physiology of the Human Breast**

The human breast is comprised of glandular and ductal tissues embedded in adipose tissue. Alveolar glandular tissues in the 15–20 lobes of the adult breast dump secretions into a converging series of excretory and lactiferous ducts that terminate in approximately 15 distinct orifices on the nipple surface [12]. These ducts are lined by stratified squamous epithelium.

---

## **Tissue-Specific Metabolic Pathways of the Breast**

The breast is the only tissue that can secrete a fully life-sustaining product. Human milk is a fat emulsion in liquid phase that contains over 100 distinct substances. The main constituents are lactose (7 %), fat (3–5 %), proteins (casein,  $\alpha$ -lactalbumin, lactoferrin, immunoglobulin A, lysozyme, and albumin; 1%” to be consistent with the inclusion of percentages of the other constituents), and minerals (0.2 %) [13].

---

## **Outside-In: Signaling of the Breast**

At birth, the breast consists mainly of primitive ductal tissues, which remain mostly quiescent until the onset of puberty. In females, pubertal elevations in circulating ovarian estrogens (mainly E2 and P4) stimulate the resumption of growth and differentiation of the rudimentary ducts. The elevations in serum P4 that accompany maturation of the hypothalamic-pituitary-ovarian axis to allow ovarian cyclicity also maintain ductal and initiate glandular growth and differentiation in the breast. Mammary development continues for several years after menarche

but will not be fully complete until late in the first trimester of a woman's initial pregnancy. All aspects of mammary growth are supported by GH and adrenal steroids.

The initiation of milk production is largely controlled by pituitary prolactin [14]. Serum levels of prolactin are elevated during the last trimester of pregnancy, but milk production is inhibited until after delivery by simultaneous elevations in serum estrogen. Oxytocin drives milk ejection. Suckling and the stimulation of additional sensorineural pathways control pituitary oxytocin secretion. Although basal serum prolactin levels return to prepregnancy levels and suckling-related spikes in prolactin secretion abate by approximately 2 months post-delivery, the breast-feeding mother may still be producing large amounts of breast milk, since milk delivery can be maintained by nipple stimulation and oxytocin alone. This can continue indefinitely.

---

### Inside-Out: Signaling of the Breast

The suckling reflex describes the series of sensory impulses that travel from the nipple to the brain with breast-feeding. These impulses cause the release of prolactin to aid in continued milk production. Prolactin inhibits the secretion of FSH from the pituitary directly, but also indirectly through inhibition of the GnRH pulse generator and appropriate pulsatile secretion of GnRH. This typically prevents ovulation in the first months after delivery and can be a contraceptive in frequent and exclusive breast-feeders [15].

---

### Final Remarks

The gonads are responsible for the production of germ cells, and the female reproductive organs support embryonic and early postnatal development. As the cells within the reproductive tissues are highly proliferative or available for remodeling, cancers of these tissues are common diseases, and the underlying hormonal signaling pathways are of critical importance for the development of both breast cancer (see chapter “[Breast](#)

[cancer](#)”) and prostate cancer (see chapter “[Prostate cancer](#)”). With regard to metabolism, the gonads are major producers of androgens and estrogens, steroid hormones that act on multiple targets throughout the body, mainly at the level of gene transcription. In addition to reproduction, they influence muscle strength, bone stability, hair growth, lipoprotein profiles, and many other physiologic functions.

---

### References

1. Jakimiuk AJ, Weitsman SR, Navab A, Magoffin DA (2001) Luteinizing hormone receptor, steroidogenesis acute regulatory protein, and steroidogenic enzyme messenger ribonucleic acids are overexpressed in thecal and granulosa cells from polycystic ovaries. *J Clin Endocrinol Metab* 86:1318–1323
2. Braak H, Braak E (1992) Anatomy of the human hypothalamus (chiasmatic and tuberal region). *Prog Brain Res* 93:3–14; discussion 14–16
3. Clifton DK, Steiner RA (2009) Neuroendocrinology of reproduction. In: Straus JF, Barbieri RL (eds) Yen and Jaffe's reproductive endocrinology, 6th edn. Elsevier Saunders, Philadelphia, pp 3–75
4. Shaw ND, Histed SN, Srouji SS, Yang J, Lee H, Hall JE (2010) Estrogen negative feedback on gonadotropin secretion: evidence for a direct pituitary effect in women. *J Clin Endocrinol Metab* 95:1955–1961
5. Lejeune H, Sanchez P, Chuzel F, Langlois D, Saez JM (1998) Time-course effects of human recombinant leuteinizing hormone on porcine Leydig cell specific differentiated functions. *Mol Cell Endocrinol* 144(1–2):59–69
6. Weinberger SE, Weiss ST, Cohen WR, Weiss JW, Johnson TS (1980) Pregnancy and the lung. *Am Rev Respir Dis* 121(3):559–581
7. Jackson DL, Schust DJ (2011) The role of the placenta in autoimmune disease and early pregnancy loss. In: Kay H, Nelson DM, Wang Y (eds) *The placenta: from development to disease*. Wiley-Blackwell Publishing, Inc, Chichester, pp 215–221
8. Schust DJ, Anderson DJ, Hill JA (1996) Progesterone-induced immunosuppression is not mediated through the progesterone receptor. *Hum Reprod* 11(5):980–985
9. Sinha-Hikim I, Taylor WE, Gonzalez-Cadavid NF, Zheng W, Bhasin S (2004) Androgen receptor in human skeletal muscle and cultured muscle satellite cells: up-regulation by androgen treatment. *J Clin Endocrinol Metab* 89(10):5245–5255
10. Pederson L, Kremer M, Judd J, Pascoe D, Spelsberg TC, Riggs BL, Oursler MJ (1999) Androgens regulate bone resorption activity of isolated osteoclasts in vitro. *Proc Natl Acad Sci U S A* 96:505–510

11. Crosnoe LE, Kim ED (2013) Impact of aging on male fertility. *Curr Opin Obstet Gynecol* 25(3):181–185
12. Rusby JE, Brachtel EF, Michaelson JS, Koerner FC, Smith BL (2007) Breast duct anatomy in the human nipple: three-dimensional patterns and clinical implications. *Breast Cancer Res Treat* 106:171–179
13. Jenness R (1979) The composition of human milk. *Semin Perinatol* 3:225–239
14. Motil KJ, Thotathuchery M, Montandon CM, Hachey DL, Boutton TW, Klein PD, Garza C (1994) Insulin, cortisol and thyroid hormones modulate maternal protein status and milk production and composition in humans. *J Nutr* 124:1248–1257
15. Konner M (1978) Nursing frequency and birth spacing in Kung hunter-gatherers. *IPPF Med Bull* 15:1–3

---

# Breast Cancer

Tanja Fehm and Eugen Ruckhäberle

---

## Introduction to Breast Cancer

Breast cancer (BC) is a type of cancer originating from the epithelium of the mammary gland. As most cancers, it can be invasive or noninvasive. Carcinomas can originate from ducts (70 %) or from lobules (10 %). Rare subtypes (mucinous, tubular, medullar, cribriform, and adenoid cystic cancers) make up the rest. Besides histology, BC is classified according to the expression of the estrogen receptor (ER), with 70 % being positive (ER<sup>+</sup>) and 30 % being negative (ER<sup>-</sup>), or the expression of the oncogene HER2 encoding the human epidermal growth factor receptor 2 (HER2), with 20–25 % Her2<sup>+</sup> BCs and 75–80 % Her2<sup>-</sup> BCs. Today, a classification by a combination of gene expression profiling and classical pathology into four subtypes, luminal A, luminal B, Her2 overexpression, and basal-like BC, is commonly used (Table 1, adapted from [1]).

BC is the most frequent female cancer worldwide with about 1.4 million newly diagnosed cases and approximately 460,000 deaths per year [2]. Whereas incidence is rising, mortality has dropped, likely resulting from improved screening programs and better systemic adjuvant

therapies (see below). Risk factors for BC are manifold and include genetics, high age at first birth, short time of breast-feeding, obesity, early menarche, late menopause, and hormonal treatment.

BC diagnosis includes mammography and sonography and, in case of suspicion, magnetic resonance imaging. Whenever any abnormality is seen, a biopsy is necessary. In general, primary and recurrent BC is considered a curable disease, while metastatic disease is not curable. Nevertheless in approximately 10–15 % of metastatic cases, survival of at least 15 years has been observed with appropriate treatment.

---

## Anatomy and Development of the Mammary Gland

The mammary ducts and alveoli of the adult human breast are lined by an inner layer of secretory luminal epithelial cells that produce milk during lactation and are surrounded by basement membrane and contractile myo-epithelial cells for milk ejection. During the pregnancy and lactation cycle, the mammary gland matures into a functional milk-secreting organ [3]. After pregnancy, these developments regress. This continuous remodeling is protective against breast cancer [4], particularly when it occurs before the age of 30 and with an interval of less than 14 years between menarche and the first pregnancy. Multiparity confers slightly more protection [5].

---

T. Fehm (✉) • E. Ruckhäberle  
Department of Obstetrics and Gynecology,  
Heinrich Heine University Düsseldorf,  
Moorenstrasse 5, Düsseldorf, 40225 Germany  
e-mail: [tanja.fehm@med.uni-duesseldorf.de](mailto:tanja.fehm@med.uni-duesseldorf.de);  
[eugen.ruckhaeberle@med.uni-duesseldorf.de](mailto:eugen.ruckhaeberle@med.uni-duesseldorf.de)

**Table 1** Intrinsic subtypes in breast cancer and recommended treatment

	Luminal-A	Luminal-B	Her2 overexpression	Basal-like
Estrogen/ progesterone status	ER and/or PR positive	ER and/or PR positive	ER/PR negative	ER/PR negative
HER2 status	Negative	Negative or positive	Positive	Negative
Ki 67	Low	Medium or high	Medium or high	High
Therapy	Endocrine	Chemotherapy ± Trastuzumab + Endocrine	Chemotherapy + Trastuzumab	Chemotherapy

The currently suggested cutoff for low Ki67 is 14 %

## Pathophysiology of Breast Cancer

Signaling downstream of the ER and HER are central to the development of breast cancer.

ER signaling is a key regulator of postnatal development of the mammary gland and can affect many cellular processes such as cardiovascular protection (i.e., antiatherosclerotic effects and reduced stroke risk, see chapters “[Atherosclerotic heart disease](#)” and “[Stroke](#)”), bone preservation (see chapter “[Osteoporosis](#)”), neuroprotection, and proliferation of many cell types. However, deregulated ER signaling promotes carcinogenesis and cancer progression. Especially ER $\alpha$  is associated with BC initiation and progression [6].

ER signaling includes a genomic and a non-genomic pathway, depending on whether the signaling initially alters gene transcription or protein activity. Whereas the genomic pathway is essential for breast carcinogenesis, the non-genomic pathway promotes BC invasion and metastasis. In contrast to its role in BC initiation, ER signaling has a protective effect in later stages, where loss of ER $\alpha$  correlates with aggressive metastatic disease.

In the genomic pathway, binding of estrogen to intracellular ER induces its dimerization and translocation to the nucleus. Binding of the ER to estrogen response elements enhances or represses transcriptional activity of its target genes, such as cyclin D1, carbonic anhydrase 12, and B cell lymphoma 2.

In the non-genomic pathway, ER $\alpha$ , ER $\beta$ , and G-protein-coupled ER (GPER) localized within caveolae (small, specialized invaginations in the plasma membrane) exert rapid responses

on protein level via a variety of adaptor proteins [7]. Common targets include Src, HER2, mitogen-activated protein kinases (MAPK), and phosphatidylinositol-3-kinase (PI3K) and the respective signaling pathways (Fig. 1 and below) [8, 9]. Non-genomic ER signaling therefore activates PI3K, Akt, and mammalian target of rapamycin (mTOR) and results in decreased apoptosis (Fig. 1). Additionally, non-genomic ER signaling activates the Ras-Raf-MAPK pathway, which increases release of matrix metalloproteinases (MMPs) via Src (Fig. 1). Genomic and non-genomic signal transduction pathways crosstalk extensively to enhance cellular processes. More specifically, transforming growth factor  $\alpha$  (TGF- $\alpha$ ) and amphiregulin, two genes induced by genomic ER signaling, can bind HER2 and consequently activate MAPK and Akt (also called protein kinase B) [10]. In BC, several MMPs are upregulated. This is a family of proteolytic enzymes that are involved in many phases of cancer progression, including angiogenesis, invasiveness, and metastasis [11, 12].

A second important pathway in BC is HER signaling. The EGFR family includes four members, HER1–4, all of which are transmembrane receptor tyrosine kinases (RTKs). Ligand binding induces dimerization and autophosphorylation. HER2 and HER3 rely on receptor heterodimerization (or very high levels, in case of HER2) for activation, as HER2 does not have a ligand, and HER3 has no kinase activity. Yet, HER2 has the strongest kinase and signaling activity and is the dimerization partner of choice. Downstream signaling pathways are associated with cell proliferation, apoptosis, angiogenesis, and metastasis (Fig. 1). HER2

can also be activated by complexing with other transmembrane receptors such as insulin-like growth factor-1 receptor (IGF-1R) [13]. Adding another level of interaction, HER2 and IGF-1 signaling can activate ER (in what is called ligand-independent activation), e.g., via MAPK, PI3K/Akt, or p38 signaling.

Obesity is linked to BC risk via various mechanisms [14]. First, the insulin-cancer hypothesis attributes an important role to insulin resistance, which causes high insulin and glucose levels (see chapter “[Diabetes mellitus](#)”). Increased activation of the insulin receptor on breast epithelial cells stimulates

cell division [15], a prerequisite for tumor formation, and high glucose concentrations may favor tumor cell proliferation and selection of malignant cells over nonmalignant ones [16]. Insulin also increases the level of sex hormone-binding globulin and thus bioavailability of estrogens. Second, synthesis and bioavailability of sex steroids, most importantly estradiol, are increased, due to the expression of aromatase by adipose tissue (see chapter “[Overview](#)” under the part “[Reproductive system](#)” and below) [17]. Finally, obesity is characterized by a state of chronic low-grade inflammation due to increased levels of pro-inflammatory

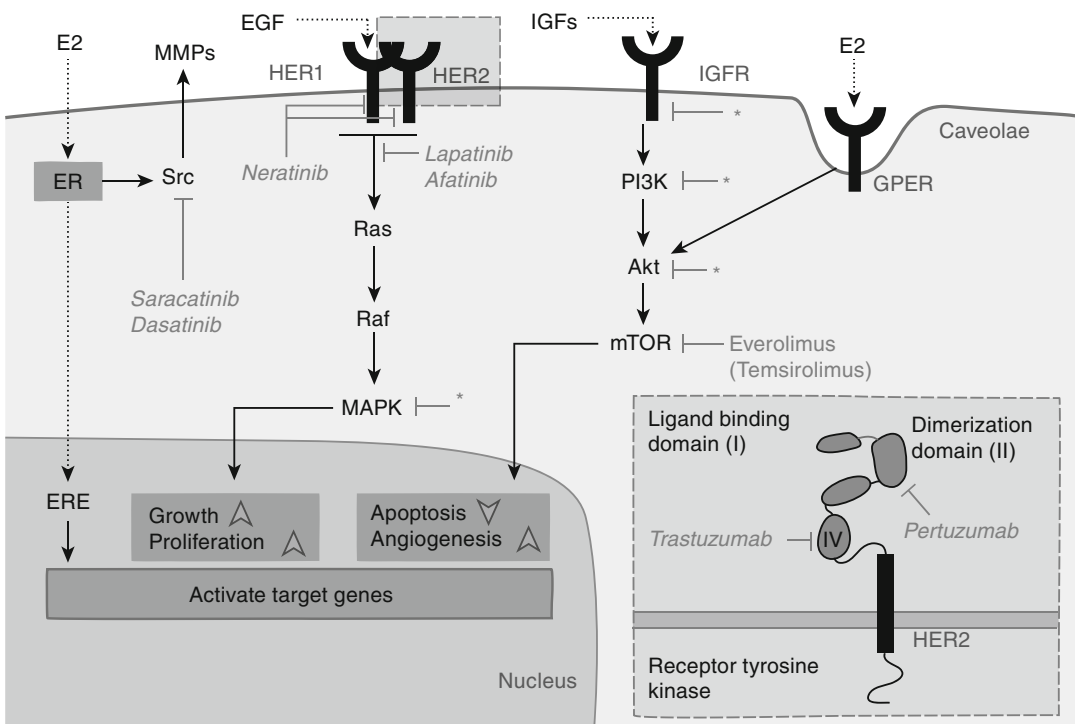

**Fig. 1** Important signaling pathways and treatment strategies in breast cancer. Important signaling pathways in breast cancer include estrogen receptor (ER), HER receptor and insulin-like growth factor receptor (IGFR or IGF-1R) signaling. Estrogen (E2) can activate intracellular ER and G-protein-coupled ER (GPER) in caveolae leading to genomic and non-genomic alterations. The former involves binding of the ER to estrogen response elements (ERE) to activate target genes involved in growth, proliferation, and transformation. The latter involves activation of Src kinase and release of matrix metalloproteinases (MMPs). ER signaling also feeds into intracellular

signaling pathways utilized by HER and IGFR, namely, signaling via Ras, Raf, and mitogen-activated protein kinase (MAPK), as well as phosphatidylinositol-3-kinase (PI3K) and Akt signaling activating mammalian target of rapamycin (mTOR). Ultimately these signals also promote cancer progression by increasing growth, proliferation, and angiogenesis and by inhibiting apoptosis. Major breast cancer treatments target these signaling pathways by blocking Src or mTOR or by interacting with multiple sites on the HER receptors. A great variety of drugs against novel targets is currently under development, as indicated by asterisks. EGF epidermal growth factor

adipokines, such as tumor necrosis factor- $\alpha$  (TNF $\alpha$ ), and the interleukins IL-1, IL-6, IL-8, and IL-10, which link to cancer [18].

## Treatment of Breast Cancer

Standard treatment of BC includes operative, systemic, and radiation treatment. Surgical treatment is still a mainstay; it is followed by local or systemic adjuvant therapy, meaning a supportive therapy to save and intensify the success of surgical BC treatment. Neoadjuvant therapy, a more recent treatment, uses the same substances and regimens like adjuvant treatment but is given before surgery. Advantages of this concept include shrinkage of the tumor and a reduced number of breast amputations.

Since circulating tumor cells are detectable in many patients at the time of breast surgery, systemic recurrence often occurs under local therapy, thus arguing for systemic adjuvant treatment. Three different systemic adjuvant therapies exist: (1) targeted therapy such as endocrine therapy or treatment blocking the HER2 pathway, (2) systemic chemotherapy, and (3) immunotherapy after primary surgery.

Targeted therapy depends on the BC subtype. Endocrine therapy, an antihormonal treatment, was the first and still is the most common adjuvant and neoadjuvant treatment. It aims to either reduce estrogen levels or to block ER signaling. Traditionally, this was achieved via ovarian ablation. However, today, drugs that target ER directly or indirectly are used. Three classes of antihormonal endocrine agents are used: selective estrogen receptor modulators (e.g., tamoxifen) that block the activity of ER, estrogen synthesis inhibitors (e.g., aromatase inhibitors such as anastrozole, letrozole, and exemestane), and selective estrogen receptor downregulators (e.g., fulvestrant) that induce destabilization and degradation of ER.

Selective ER modulators (SERMs), e.g., tamoxifen and raloxifene, competitively inhibit binding of estrogen to ER $\alpha$ , blocking both its genomic and non-genomic activity. Tamoxifen hampers interactions with activators and blocks transcription of ER target genes.

Estrogen synthesis inhibitors are often aromatase inhibitors and decrease estrogen levels, because estrogens are produced from androstenedione and testosterone via aromatase (see chapter “[Overview](#)” under the part “Reproductive system”). This effect is most relevant in postmenopausal women, in whom estrogen production occurs primarily by aromatization in peripheral tissues such as adipose tissue. Steroidal aromatase inhibitors (e.g., exemestane) bind irreversibly, and nonsteroidal aromatase inhibitors (e.g., anastrozole) bind reversibly to inhibit aromatase activity.

Finally, selective ER downregulators (SERDs) induce receptor polyubiquitination and subsequent degradation via the proteasome. The SERD fulvestrant is a pure antagonist with no agonistic effect, in contrast to tamoxifen.

Side effects of antihormonal therapy include hot flashes, sleeping disturbances, huffiness, a decrease in bone density (see chapter “[Osteoporosis](#)”), weight gain, and an increase in cholesterol. Unfortunately, up to 50 % of patients on endocrine therapy exhibit a primary (de novo) or acquired resistance [19]. Potential escape mechanisms include loss or modification of ER expression, cross talk between pathways, an alteration in the expression of specific micro-RNA, and alterations in drug metabolism [20, 21].

Treatments against HER2 include monoclonal antibodies and tyrosine kinase inhibitors. The first approved agent was trastuzumab, a monoclonal antibody (thus the ending –mab). It substantially improves outcomes in early-stage and metastatic BC and likely induces internalization and degradation of HER2, disrupting signaling and by this resulting in apoptosis (Fig. 1). Side effects are rare as trastuzumab is specific for HER2. However, de novo and acquired resistance occur. Escape mechanisms may include signaling through alternative receptors (e.g., IGF-1R), upregulation of downstream signaling pathways, and failure to elicit an appropriate immune response against the trastuzumab-bound BC cells [22, 23]. Thus, new treatment concepts also target escape mechanisms [24]. For example,



everolimus (Fig. 1), an mTOR inhibitor, demonstrated favorable results in ER+ metastatic BC patients with acquired resistance to anti-HER2 treatment.

Tyrosine kinase inhibitors prevent phosphorylation of the cytoplasmic tyrosine kinase domain of all HER kinases and subsequent intracellular signaling [25]. Lapatinib (Fig. 1), one of the few tyrosine kinase inhibitors on the market, targets HER1 and HER2. Side effects include diarrhea and rash due to unspecific binding. Future inhibitors will show improved targeting and administration.

Chemotherapy has a significant impact on prognosis. Common chemotherapeutics include alkylating agents, antimetabolites, antibiotics, topoisomerase inhibitors, and plant alkaloids. Alkylating agents damage DNA to prevent cellular reproduction. Antimetabolites interfere with DNA and RNA synthesis by substituting for regular building blocks. Anthracyclines are antitumor antibiotics that interfere with enzymes involved in DNA replication. Topoisomerase inhibitors prevent separation of DNA strands in the M phase of the cell cycle. Plant alkaloids (e.g., taxanes, vinorelbine) can stop mitosis during M phase by preventing microtubule function. Vinca alkaloids originally derived from the periwinkle plant prevent formation of the microtubules, whereas taxanes (diterpenes, such as Taxol, derived from other plants) prevent microtubule disassembly.

Side effects of chemotherapy are mainly caused by the antiproliferative effect on normal, rapidly growing cell types, such as hair follicle cells, blood cells, and enteric epithelial cells, and thus include alopecia (loss of hair), anemia, infections, and diarrhea. Side effects of anti-Her2 therapy include shivering, fever, and a decrease of the left ventricular ejection fraction of the heart.

Finally, the role of diet and physical activity in cancer prevention is complex. Regular activity is associated with reduced risk of BC by indirect reduction of sex hormones due to reduced adipose tissue and adipokines, by preventing insulin resistance and chronic inflammation and by improving immune function.

## Perspectives

Early diagnosis allows breast-conserving surgery and preserves better prognosis. Moreover, with increasing understanding of BC carcinogenesis, primary prevention strategies come to the fore. Concepts of preventing or treating obesity with diet, physical activity, and agents like metformin are part of ongoing trials. Metformin, a drug used to treat type 2 diabetes (see chapter “[Diabetes mellitus](#)”), is currently being studied as an anti-cancer agent [26–29]. Other agents that are now tested target intracellular signaling pathways directly to complement current targeted therapy. Several new antibodies, some simultaneously acting as cytotoxic chemotherapeutics, are also in development. Current research on food and diet investigates anti-inflammatory effects of herbs and spices such as curcuma, ginger, and flavonoids [30, 31].

New targeted agents might help to improve the poor prognosis of basal-like BC patients, for whom currently chemotherapy is the only therapeutic option. Finally, the ultimate goal of all kinds of diagnosis and treatment of BC will be an individualized, tailored therapy.

---

## References

1. Goldhirsch A, Wood WC, Coates AS, Gelber RD, Thürlimann B, Senn HJ (2011) Strategies for subtypes—dealing with the diversity of breast cancer: highlights of the St. Gallen International Expert Consensus on the primary therapy of early breast cancer 2011. *Ann Oncol* 22:1736–1747
2. Youlden DR, Cramb SM, Dunn NA, Muller JM, Pyke CM, Baade PD (2012) The descriptive epidemiology of female breast cancer: an international comparison of screening, incidence, survival and mortality. *Cancer Epidemiol* 36:237–248
3. Stügl J (2011) Estrogen and progesterone in normal mammary gland development and in cancer. *Horm Cancer* 2:85–90
4. Key TJ, Verkasalo PK, Banks E (2001) Epidemiology of breast cancer. *Lancet Oncol* 2:133–140
5. Russo IH, Russo J (2011) Pregnancy-induced changes in breast cancer risk. *J Mammary Gland Biol Neoplasia* 16:221–233
6. Osborne CK, Schiff R, Fuqua SA, Shou J (2001) Estrogen receptor: current understanding of its activation and modulation. *Clin Cancer Res* 7:4338s–4342s



7. Razandi M, Oh P, Pedram A, Schnitzer J, Levin ER (2002) ERs associate with and regulate the production of caveolin: implications for signaling and cellular actions. *Mol Endocrinol* 16:100–115
8. Migliaccio A, Piccolo D, Castoria G, Di Domenico M, Bilancio A, Lombardi M, Gong W, Beato M, Auricchio F (1998) Activation of the Src/p21ras/Erk pathway by progesterone receptor via cross-talk with estrogen receptor. *EMBO J* 17:2008–2018
9. Schiff R, Massarweh SA, Shou J, Bharwani L, Mohsin SK, Osborne CK (2004) Cross-talk between estrogen receptor and growth factor pathways as a molecular target for overcoming endocrine resistance. *Clin Cancer Res* 10:S331–S336
10. Deroo BJ, Korach KS (2006) Estrogen receptors and human disease. *J Clin Invest* 116:561–570
11. Hadler-Olsen E, Winberg JO, Uhlin-Hansen L (2013) Matrix metalloproteinases in cancer: their value as diagnostic and prognostic markers and therapeutic targets. *Tumour Biol* 34:2041–2051
12. Köhrmann A, Kammerer U, Kapp M, Dietl J, Anacker J (2009) Expression of matrix metalloproteinases (MMPs) in primary human breast cancer and breast cancer cell lines: new findings and review of the literature. *BMC Cancer* 9:188
13. Nahta R, Yuan LX, Zhang B, Kobayashi R, Esteva FJ (2005) Insulin-like growth factor-I receptor/human epidermal growth factor receptor 2 heterodimerization contributes to trastuzumab resistance of breast cancer cells. *Cancer Res* 65:11118–11128
14. Patterson RE, Rock CL, Kerr J, Natarajan L, Marshall SJ, Pakiz B, Cadmus-Bertram LA (2013) Metabolism and breast cancer risk: frontiers in research and practice. *J Acad Nutr Diet* 113(2):288–296
15. Faulds MH, Dahlman-Wright K (2012) Metabolic diseases and cancer risk. *Curr Opin Oncol* 24:58–61
16. Muti P, Quattrin T, Grant BJ, Krogh V, Micheli A, Schünemann HJ, Ram M, Freudenheim JL, Sieri S, Trevisan M, Berrino F (2002) Fasting glucose is a risk factor for breast cancer: a prospective study. *Cancer Epidemiol Biomarkers Prev* 11:1361–1368
17. Renehan AG, Frystyk J, Flyvbjerg A (2006) Obesity and cancer risk: the role of the insulin-IGF axis. *Trends Endocrinol Metab* 17(8):328–336
18. Heikkila K, Ebrahim S, Lawlor DA (2007) A systematic review of the association between circulating concentrations of C reactive protein and cancer. *J Epidemiol Community Health* 61:824–833
19. Davies C, Godwin J, Gray R, Clarke M, Cutter D, Darby S, McGale P, Pan HC, Taylor C, Wang YC, Dowsett M, Ingle J, Peto R (2011) Relevance of breast cancer hormone receptors and other factors to the efficacy of adjuvant tamoxifen: patient-level meta-analysis of randomised trials. *Lancet* 378:771–784
20. Fedele P, Calvani N, Marino A, Orlando L, Schiavone P, Quaranta A, Cinieri S (2012) Targeted agents to reverse resistance to endocrine therapy in metastatic breast cancer: where are we now and where are we going? *Crit Rev Oncol Hematol* 84:243–251
21. Bianco S, Gévry N (2012) Endocrine resistance in breast cancer: from cellular signaling pathways to epigenetic mechanisms. *Transcription* 3:165–170
22. Hubalek M, Brunner C, Matthä K, Marth C (2010) Resistance to HER2-targeted therapy: mechanisms of trastuzumab resistance and possible strategies to overcome unresponsiveness to treatment. *Wien Med Wochenschr* 160:506–512
23. Pohlmann PR, Mayer IA, Mernaugh R (2009) Resistance to trastuzumab in breast cancer. *Clin Cancer Res* 15:7479–7491
24. Tsang RY, Finn RS (2012) Beyond trastuzumab: novel therapeutic strategies in HER2-positive metastatic breast cancer. *Br J Cancer* 106(1):6–13
25. Mendelsohn J, Baselga J (2003) Status of epidermal growth factor receptor antagonists in the biology and treatment of cancer. *J Clin Oncol* 21:2787–2799
26. Gallagher EJ, LeRoith D (2011) Diabetes, cancer, and metformin: connections of metabolism and cell proliferation. *Ann NY Acad Sci* 1243:54–68
27. Bodmer M, Meier C, Krahenbuhl S, Jick SS, Meier CR (2010) Long-term metformin use is associated with decreased risk of breast cancer. *Diabetes Care* 33(6):1304–1308
28. Shaw RJ, Lamia KA, Vasquez D, Koo SH, Bardeesy N, Depinho RA, Montminy M, Cantley LC (2005) The kinase LKB1 mediates glucose homeostasis in liver and therapeutic effects of metformin. *Science* 310(5754):1642–1646
29. Alimova IN, Liu B, Fan Z, Edgerton SM, Dillon T, Lind SE, Thor AD (2009) Metformin inhibits breast cancer cell growth, colony formation and induces cell cycle arrest in vitro. *Cell Cycle* 8(6):909–915
30. Jungbauer A, Medjakovic S (2012) Anti-inflammatory properties of culinary herbs and spices that ameliorate the effects of metabolic syndrome. *Maturitas* 71(3):227–239
31. Baliga MS, Haniadka R, Pereira MM, D'Souza JJ, Pallaty PL, Bhat HP, Popuri S (2011) Update on the chemopreventive effects of ginger and its phytochemicals. *Crit Rev Food Sci Nutr* 51(6):499–523

---

# Prostate Cancer

Rahul Aggarwal and Eric Small

---

## Introduction to Prostate Cancer

Prostate cancer (PC) is the second most common cancer in men worldwide, with over 900,000 new cases per year [1]. The strongest risk factors for PC include age, genetic factors [2], and metabolic parameters. Among men with one, two, or three first-degree relatives with PC, the risk of PC is increased 2-, 5-, and 11-fold, respectively. Obese patients (as defined by body mass index) have an increased risk of PC, including a more aggressive phenotype [3]. The underlying mechanisms are unclear; prior studies examining serum androgen, estrogen, and insulin levels have provided inconclusive evidence of an association of these hormones with elevated risk of PC.

For patients with disease that is confined to the prostate gland at the time of diagnosis, PC can be curable with surgery and/or radiation therapy to the prostate gland. For patients with more advanced, metastatic cancer, or those with disease progression after prior local therapy (termed

biochemical relapse, see below), treatment is often applied systemically to provide control of cancer and palliation of symptoms.

---

## Pathophysiology of Prostate Cancer

PC is unique among cancers in its exquisite dependence upon circulating androgens that drive tumor progression via activation of the androgen receptor (AR). Circulating androgens, synthesized from cholesterol precursors (see chapter “Overview” under the part “Reproductive system”), are derived primarily from the testes and adrenal gland. Activation of AR follows the common path of intracellular steroid receptors (see chapter “Overview” under the part “Reproductive system”) and activates genes involved in cellular metabolism, cell cycle progression, and cellular proliferation [4].

Over the past decade, a number of genetic events have been discovered that lead to the progression from benign PC tissue to precancerous lesions (prostatic intraepithelial neoplasia) and overt PC. These early inciting genetic events include loss of the tumor suppressor gene phosphatase and tensin homologue (PTEN) and fusions of the genes for *TMPRSS2* and a transcription factor of the ETS (E-twenty-six) family, which is observed in over half of PC tumors [5]. Activation of the AR increases transcription of this fusion product, driving PC proliferation.

---

R. Aggarwal (✉) • E. Small  
Division of Hematology/Oncology,  
Department of Medicine,  
University of California San Francisco,  
1600 Divisadero St, Room B745,  
San Francisco, CA 94143, USA  
e-mail: [rahul.aggarwal@ucsf.edu](mailto:rahul.aggarwal@ucsf.edu);  
[smalle@medicine.ucsf.edu](mailto:smalle@medicine.ucsf.edu)

## Androgen Deprivation Therapy and Mitigating Its Adverse Metabolic Impact

Targeting androgen signaling by “upstream” androgen synthesis inhibition or blockade of AR downstream signaling triggers apoptosis of PC cells. The traditional method of lowering circulating androgens with surgical orchiectomy (removal of the testes) causes PCs to shrink, painful bone metastases to recede, and patients to live longer. Lowering circulating androgens to treat PC (termed androgen deprivation therapy, or ADT) remains the mainstay of primary systemic therapy for PC. Contemporarily, ADT is delivered medically rather than surgically with the use of gonadotropin-releasing hormone (GnRH) analogues, which suppress pituitary-mediated stimulation of testosterone production from the testis (see chapter “[Overview](#)” under the part “[Reproductive system](#)”). The effectiveness of ADT relies upon the exquisite dependence on androgens in the vast majority of PCs.

However, by inducing a castrate state with a marked decline in circulating testosterone and therefore estrogen levels, ADT is associated with significant metabolic derangements, including decreased bone mineral density and increased risk of osteoporotic fractures (see chapter “[Osteoporosis](#)”) [6], increased risk of insulin resistance and overt diabetes mellitus (see chapter “[Diabetes mellitus](#)”) [7], dyslipidemia (see chapter “[Hyperlipidemia](#)”), increases in visceral fat (see chapter “[Metabolic syndrome](#)”), and, potentially, an increased risk of cardiovascular mortality (see chapter “[Atherosclerotic heart disease](#)”, Fig. 1). Interestingly, the development of insulin resistance and hyperinsulinemia is linked with increased risk of PC progression, through putative cross-activation of the insulin-like growth factor-1 (IGF-1) receptor by insulin, which is often upregulated in PC [8]. To mitigate the metabolic side effects of ADT, various treatment strategies have been developed (see below).

## Intermittent ADT

Intermittent ADT usually consists of preplanned breaks in therapy after a duration of 6–12 months, to allow for testosterone recovery and partial mitigation of side effects and metabolic impact. Prior studies have shown that during the “off” intervals, significant improvements in bone mineral density can be observed as the circulating testosterone and estrogen levels recover [9]. Intermittent ADT is now established as standard treatment in nonmetastatic PCs and a viable alternative in metastatic PCs, especially in patients with significant metabolic comorbidities (mentioned above) [10, 11].

## Peripheral Androgen Blockade

Alternatively, the use of AR-specific antagonists (e.g., bicalutamide, nilutamide), without concurrent castrating GnRH analogue therapy, represents a viable treatment alternative to ADT. AR antagonist monotherapy inhibits activation of the AR, thereby controlling cancer growth while potentially mitigating those toxicities of ADT related to depletions in circulating estrogen levels. For example, bicalutamide monotherapy leads to elevations in serum testosterone and estrogen levels via loss of negative feedback provided by AR activation and is associated with corresponding improvement in bone mineral density [12]. The availability of more potent AR antagonists of the second generation (e.g., enzalutamide, see below) has further stimulated interest in developing peripheral blockade as a non-castrating primary hormonal treatment strategy.

---

## Castration-Resistant Prostate Cancer and Approaches to Treat It

Despite the initial effectiveness of ADT in the vast majority of patients, the duration of response is highly variable, and disease progression on ADT is nearly universal. Though ADT markedly lowers circulating androgen levels, it does not reduce the

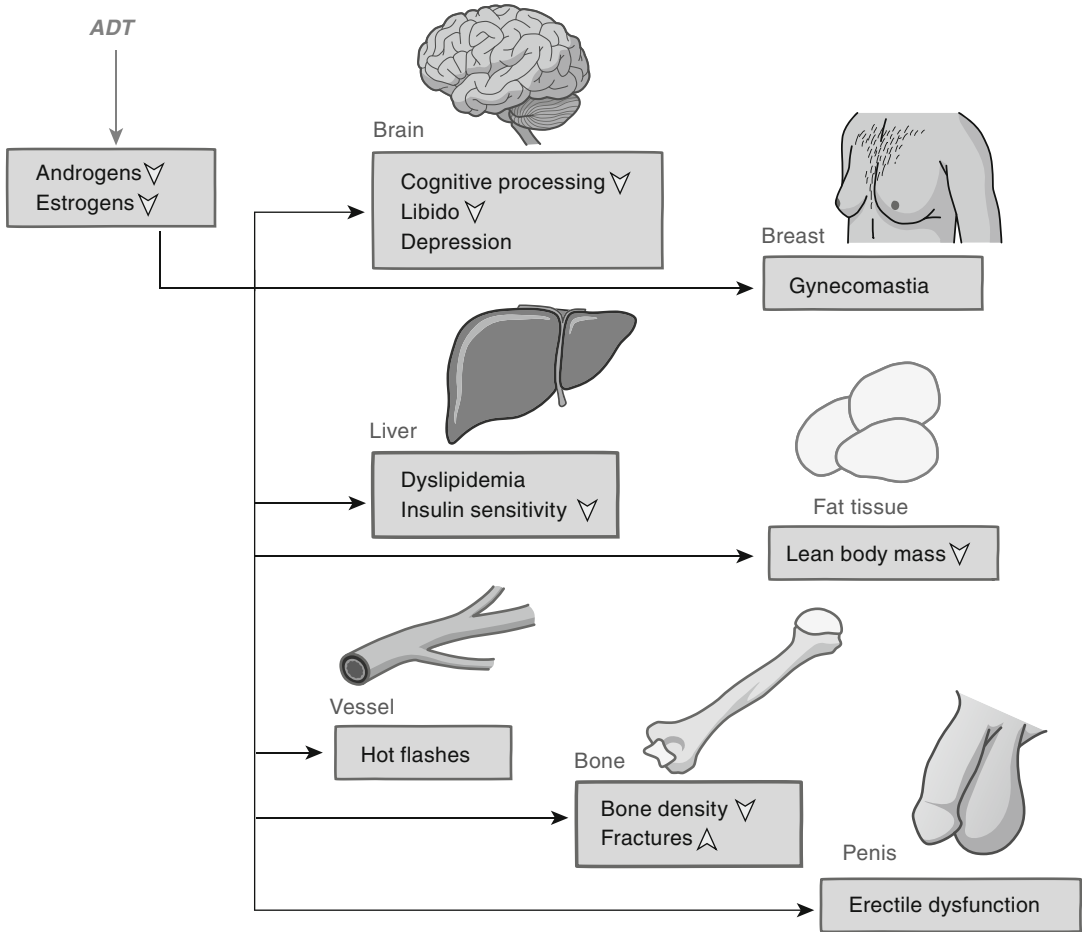
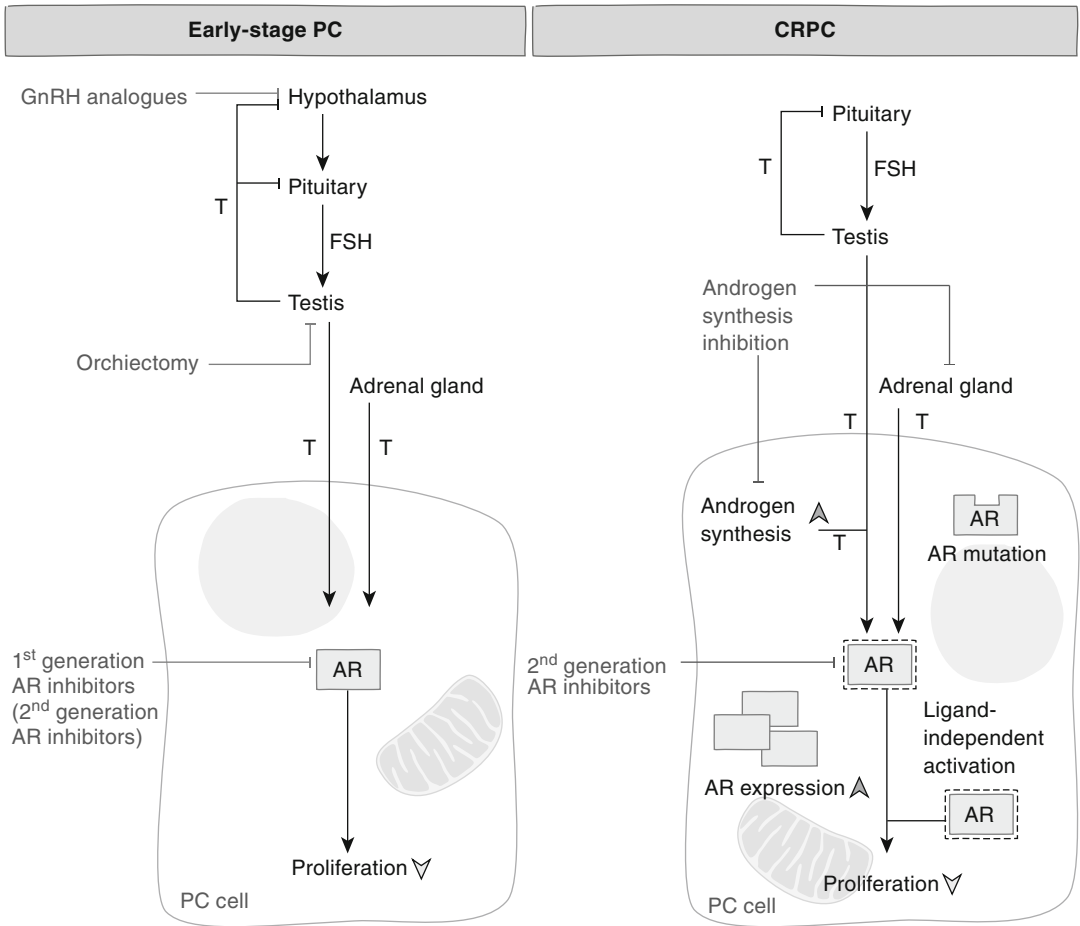

**Fig. 1** Metabolic toxicities associated with androgen deprivation therapy. Gynecomastia is a significant breast enlargement in men. *ADT* androgen deprivation therapy

levels to zero, and the androgens that remain can stimulate PC growth in this setting. PC that has progressed on primary ADT (as described above) was formerly thought to be “hormone refractory” or “castrate resistant” (CRPC) and independent of signaling through the androgen receptor. In addition, it was observed that discontinuing first-generation AR antagonist treatment at the time of disease progression can lead to declines in serum prostate-specific antigen, a clinical marker of PC progression, and regression of tumors (termed antiandrogen withdrawal response) in a subset of patients [13]. As first-generation AR antagonists show small residual agonistic activity, thus activating AR signaling even under ADT treatment,

this has led to two key insights: (i) tumors often remain dependent on AR signaling in CRPC, and (ii) further manipulations to inhibit the androgen signaling axis have significant therapeutic potential in this setting.

Key adaptations which allow disease progression on first-generation ADT include (1) increased expression of AR [14]; (2) AR mutations, which increase promiscuity of ligand-mediated activation, e.g., allowing estradiol or progesterone to bind [15]; (3) upregulation of intra-tumoral androgen synthesis [16]; and (4) ligand-independent activation of the AR potentially via constitutively active AR splice variants (Fig. 2) [17]. Secondary hormonal therapies



**Fig.2** Molecular mechanism and treatment approaches in early-stage and castrate-resistant prostate cancer. Cellular adaptations that promote continued androgen signaling in castration-resistant prostate cancer (CRPC) are shown in

the prostate cancer (PC) cell on the right. *GnRH* gonadotropin-releasing hormone, *FSH* follicular-stimulating hormone, *T* testosterone, *AR* androgen receptor

targeting these adaptations have been developed, which have significant activity against PCs in this setting.

### Androgen Synthesis Inhibition

Blockade of androgen synthesis from the adrenal gland and the PC cells itself has been developed as an effective treatment strategy. Ketoconazole is a nonspecific inhibitor of multiple enzymatic steps within the adrenal androgen hormone synthesis pathway (see chapter “Overview” under the part “Reproductive system”), with demonstrated clinical activity in PC. Novel androgen synthesis

inhibitors such as abiraterone acetate have been developed to more selectively and potently target the cytochrome P450 17 enzyme, which shunts pregnenolone and progesterone precursors down the androgenic pathway [18]. One of the metabolic side effects of selective cytochrome P450 17 inhibition is elevation of mineralocorticoids (see chapter “Overview” under the part “Reproductive system”), including corticosterone and 11-deoxycortisol, which can cause hypertension, hypokalemia, and peripheral edema. These effects can be partially abrogated with the concomitant administration of low-dose corticosteroids, which block adrenal mineralocorticoid synthesis via feedback inhibition of the pituitary gland.

## Second-Generation AR Antagonists

Novel, second-generation AR antagonists (enzalutamide, ARN-509) were developed using prostate cancer models with AR overexpression, simulating the molecular characteristics commonly observed with CRPC tumors [19]. Second-generation AR antagonists are ten times more potent than first-generation drugs and lack any agonistic activity. Use of these agents in CRPC has significant clinical benefit [20]. The long-term metabolic consequences of potent AR blockade remain to be elucidated in follow-up studies.

## Perspectives

As potent androgen axis inhibitors have demonstrated clinical benefit in advanced CRPC, the role of these agents in improving the efficacy and mitigating the toxicity of standard ADT in earlier disease settings is being explored. The availability of potent AR antagonists offers the possibility to deliver non-castrating yet highly potent therapy to control PC and minimize the development of metabolic derangements by avoiding estrogen depletion. Clinical trials are underway to test this hypothesis. Ultimately, rather than uniformly applying ADT to all patients with PC, future therapy might be delivered on a risk-adapted basis, with non-castrating peripheral AR blockade as monotherapy for patients with standard-risk disease, and combination therapy with GnRH analogues in those predicted to have a short duration of response to primary ADT. Such an approach may offer a more favorable risk-benefit ratio of therapy and partially mitigate the long-term metabolic toxicities of ADT given the chronic nature of advanced PC treatment.

## References

1. Siegel R, Naishadham D, Jemal A (2013) Cancer statistics, 2013. *CA Cancer J Clin* 63:11–30
2. Steinberg GD, Carter BS, Beaty TH, Childs B, Walsh PC (1990) Family history and the risk of prostate cancer. *Prostate* 17(4):337–347

3. MacInnis RJ, English DR (2006) Body size and composition and prostate cancer risk: systematic review and meta-regression analysis. *Cancer Causes Control* 17(8):989–1003
4. Sharma NL, Massie CE, Ramos-Montoya A, Zecchini V, Scott HE, Lamb AD, MacArthur S, Stark R, Warren AY, Mills IG, Neal DE (2013) The androgen receptor induces a distinct transcriptional program in castration-resistant prostate cancer in man. *Cancer Cell* 23(1):35–47
5. Yu J, Yu J, Mani RS, Cao Q, Brenner CJ, Cao X, Wang X, Wu L, Li J, Hu M, Gong Y, Cheng H, Laxman B, Vellaichamy A, Shankar S, Li Y, Dhanasekaran SM, Morey R, Barrette T, Lonigro RJ, Tomlins SA, Varambally S, Qin ZS, Chinnaiyan AM (2010) An integrated network of androgen receptor, polycomb, and TMPRSS2-ERG gene fusions in prostate cancer progression. *Cancer Cell* 17(5):443–454
6. Shahinian VB, Kuo YF, Freeman JL, Goodwin JS (2005) Risk of fracture after androgen deprivation for prostate cancer. *N Engl J Med* 352:154–164
7. Keating NL, O'Malley J, Smith MR (2006) Diabetes and cardiovascular disease during androgen deprivation therapy for prostate cancer. *J Clin Oncol* 24:4448–4456
8. Aggarwal R, Ryan CJ, Chan J (2013) Insulin-like growth factor pathway: a link between androgen deprivation therapy (ADT), insulin resistance, and disease progression in patients with prostate cancer? *Urol Oncol* 31:522–530
9. Yu EY, Kuo KF, Gulati R, Chen S, Gambol TE, Hall SP, Jiang PY, Pitzel P, Higano CS (2012) Long-term dynamics of bone mineral density during intermittent androgen deprivation for men with nonmetastatic, hormone-sensitive prostate cancer. *J Clin Oncol* 30(15):1864–1870
10. Crook JM, O'Callaghan CJ, Duncan G, Dearnaley DP, Higano CS, Horwitz EM, Frymire E, Malone S, Chin J, Nabad A, Warde P, Corbett T, Angyalfi S, Goldenberg SL, Gospodarowicz MK, Saad F, Logue JP, Hall E, Schellhammer PF, Ding K, Klotz L (2012) Intermittent androgen suppression for rising PSA level after radiotherapy. *N Engl J Med* 367:895–903
11. Hussain M, Tangen CM, Berry DL, Higano CS, Crawford ED, Liu G, Wilding G, Prescott S, Kanaga Sundaram S, Small EJ, Dawson NA, Donnelly BJ, Venner PM, Vaishampayan UN, Schellhammer PF, Quinn DI, Raghavan D, Ely B, Moinpour CM, Vogelzang NJ, Thompson IM Jr (2013) Intermittent versus continuous androgen deprivation in prostate cancer. *N Engl J Med* 368(14):1314–1325
12. Smith MR, Goode M, Zietman AL, McGovern FJ, Lee H, Finkelstein JS (2004) Bicalutamide monotherapy versus leuprolide monotherapy for prostate cancer: effects on bone mineral density and body composition. *J Clin Oncol* 22:2546–2553
13. Small EJ, Halabi S, Dawson NA, Stadler WM, Rini BI, Picus J, Gable P, Torti FM, Kaplan E,

- Vogelzang NJ (2004) Antiandrogen withdrawal alone or in combination with ketoconazole in androgen-independent prostate cancer patients: a phase III trial (CALGB 9583). *J Clin Oncol* 22:1025–1033
14. Taylor BS, Schultz N, Hieronymus H, Gopalan A, Xiao Y, Carver BS, Arora VK, Kaushik P, Cerami E, Reva B, Antipin Y, Mitsiades N, Landers T, Dolgalev I, Major JE, Wilson M, Socci ND, Lash AE, Heguy A, Eastham JA, Scher HI, Reuter VE, Scardino PT, Sander C, Sawyers CL (2010) Integrative genomic profiling of human prostate cancer. *Cancer Cell* 18:11–22
  15. Taplin ME, Rajeshkumar B, Halabi S, Werner CP, Woda BA, Picus J, Stadler W, Hayes DF, Kantoff PW, Vogelzang NJ, Small EJ (2003) Androgen receptor mutations in androgen-independent prostate cancer: Cancer and Leukemia Group B Study 9663. *J Clin Oncol* 21:2673–2678
  16. Montgomery RB, Mostaghel EA, Vessella R, Hess DL, Kalhorn TF, Higano CS, True LD, Nelson PS (2008) Maintenance of intratumoral androgens in metastatic prostate cancer: a mechanism for castration-resistant tumor growth. *Cancer Res* 68:4447–4454
  17. Guo Z, Yang X, Sun F, Jiang R, Linn DE, Chen H, Chen H, Kong X, Melamed J, Tepper CG, Kung HJ, Brodie AM, Edwards J, Qiu Y (2009) A novel androgen receptor splice variant is up-regulated during prostate cancer progression and promotes androgen depletion-resistant growth. *Cancer Res* 69:2305–2313
  18. Ryan CJ, Smith MR, Fong L, Rosenberg JE, Kantoff P, Raynaud F, Martins V, Lee G, Kheoh T, Kim J, Molina A, Small EJ (2010) Phase I clinical trial of the CYP17 inhibitor abiraterone acetate demonstrating clinical activity in patients with castration-resistant prostate cancer who received prior ketoconazole therapy. *J Clin Oncol* 28:1481–1488
  19. Tran C, Ouk S, Clegg NJ, Chen Y, Watson PA, Arora V, Wongvipat J, Smith-Jones PM, Yoo D, Kwon A, Wasielewska T, Welsbie D, Chen CD, Higano CS, Beer TM, Hung DT, Scher HI, Jung ME, Sawyers CL (2009) Development of a second-generation antiandrogen for treatment of advanced prostate cancer. *Science* 324:787–790
  20. Scher HI, Fizazi K, Saad F, Taplin ME, Sternberg CN, Miller K, de Wit R, Mulders P, Chi KN, Shore ND, Armstrong AJ, Flaig TW, Fléchon A, Mainwaring P, Fleming M, Hainsworth JD, Hirmand M, Selby B, Seely L, de Bono JS (2012) Increased survival with enzalutamide in prostate cancer after chemotherapy. *N Engl J Med* 367:1187–1197

---

**Part XVI**

**Cancer**



---

# Overview

Zachary E. Stine and Chi V. Dang

---

## Introduction to Cancer

Cancer is one of the leading causes of death. Cancer cells grow and multiply rapidly, causing them to have metabolic needs differing from those of more slowly dividing noncancerous cells [1]. While many quiescent cells need only to meet the energy demands required for homeostasis, cancer cells need to produce not only energy but also the cellular building blocks required for rapid growth. Cancer cells reprogram their metabolism to provide the components for macromolecular biosynthesis, i.e., nucleotides to produce new deoxyribonucleic acid, lipids to create new cell membranes, and ribosomes and amino acids required for increased protein production [1]. Cancer is challenging to treat due to its similarity to noncancerous cells and the high amount of inter-tumor and intra-tumor heterogeneity.

---

## Cancer Metabolism and Possible Outcomes

In order to transform into a cancer cell, somatic cells need to collect a series of mutations, allowing for unlimited growth and replication. Traditionally,

---

Z.E. Stine • C.V. Dang (✉)  
Abramson Cancer Center, University of Pennsylvania,  
421 Curie Blvd, BRB 449, Philadelphia,  
PA 19104, USA  
e-mail: [zstine@gmail.com](mailto:zstine@gmail.com);  
[dangvchi@exchange.upenn.edu](mailto:dangvchi@exchange.upenn.edu)

mutations in at least two major classes of determinants are required: oncogenes, whose constitutive activation drives a cell toward cancer (such as growth factor receptors), and tumor suppressors, whose inactivation removes important stop signs or protective pathways.

Constant cell division requires continuous production of cellular building blocks, making reprogrammed metabolism central to cancer progression. Consequently, many cancer-promoting mutations directly (or indirectly) affect cellular metabolism. Subsequently, major changes in metabolism are discussed, followed by important examples of common cancer mutations which reprogram cancer metabolism.

## Changes in Metabolism

Quiescent, healthy cells primarily convert glucose to pyruvate, to enter the citric acid cycle, also called tricarboxylic acid (TCA) cycle in the mitochondria to efficiently produce ATP with oxygen as the final electron acceptor. However, cancer cells often show increased glucose uptake and increased glycolysis even in the presence of oxygen [2], converting pyruvate to lactate to regenerate nicotinamide adenine dinucleotide (NAD<sup>+</sup>) required for increased glycolysis (Fig. 1). Noncancerous cells generally convert glucose to lactate only in hypoxia. This phenomenon of glucose being converted to lactate in the presence of oxygen is termed Warburg effect, also known as aerobic glycolysis, as it was first

reported by Otto Warburg back in the 1920s. Many, but not all, cancers exhibit aerobic glycolysis [2]. While aerobic glycolysis produces much fewer ATP per molecule of glucose than oxidative glucose catabolism, it allows glucose to contribute to alternative biosynthetic pathways that begin with glycolytic intermediates, while the cells utilize other sources of energy for ATP production. Thus, aerobic glycolysis shunts glucose carbons for biosynthesis and catabolizes glucose to lactate for rapid ATP production [3]. The avid uptake of glucose by cancer cells is even used to identify tumors. Using a labeled glucose derivative,  $^{18}\text{F}$ -deoxyglucose, positron-emission tomography (PET) allows localization and imaging of tumors in patients.

Glycolysis shares common intermediates with other anabolic pathways. For example, the pentose phosphate pathway (PPP, see also chapter “Sickle cell disease”) shares glucose 6-phosphate as a starting molecule with glycolysis (Fig. 1) [4]. In the PPP, glucose 6-phosphate is converted to ribose by a multiple-step pathway, the 5-carbon sugar required for nucleotide synthesis. Additionally, the PPP is a major source of NADPH (nicotinamide adenine dinucleotide phosphate), a reducing agent required for nucleic acid synthesis, fatty acid synthesis, and detoxification of reactive oxygen species. Therefore, the PPP provides much of the reducing power and ribose that cancer cells require for nucleotide biosynthesis.

In proliferating cells, glucose is critically required as a donor of methyl groups. To this end, glucose, or rather the glycolytic intermediate, 3-phosphoglycerate, is first converted to serine [5], which is then converted to glycine (or used for protein synthesis) (Fig. 1). Glycine is an important carbon donor [6] and source of CHO-groups or  $\text{CH}_2$ -tetrahydrofolate, which are both used for nucleotide and methionine synthesis. Indeed, many rapidly proliferating cancer cells are dependent on increased serine and glycine uptake and synthesis [5, 6]. Diversion of glucose into the serine/glycine synthesis pathways allows cancer cells to create building blocks for growth.

Warburg mistakenly believed that glucose is robustly converted to lactate due to a lack of functioning mitochondria in all cancer cells. In

fact, mitochondria are functional in many cancers [7]. The TCA cycle provides precursors for cellular building blocks (Fig. 1). It provides citrate for fatty acid synthesis, malate, which can be used for the production of NADPH through conversion to pyruvate, or oxaloacetate for synthesis of aspartate, which in turn is used to synthesize nucleotides or other amino acids (Fig. 1). However, since little glucose enters the TCA cycle due to the Warburg effect, many cancer cells fuel the TCA cycle with glutamine (Gln) [8], and in culture, many cancer cells fail to grow when deprived of Gln. To enter the TCA cycle, Gln is first converted to glutamate by glutaminase and then to the TCA cycle intermediate  $\alpha$ -ketoglutarate by glutamate dehydrogenase (GLUD) or aminotransferases. Importantly, using this mechanism, Gln can fuel the TCA cycle even in hypoxic conditions, allowing cells to obtain the required building block and survive in the poorly vascularized hypoxic tumor environment [9]. Additionally, Gln plays a central role in the formation of the antioxidant tripeptide glutathione through its role in glutamate production and cysteine import, which is critical for controlling reactive oxygen species [10].

Proliferating cells need to generate sufficient lipids (in form of triglycerides and phospholipids) to make cell membrane for growth and cell division and for storage of energy [11]. While some lipids may be obtained exogenously, many cancers synthesize lipids de novo. Fatty acid synthesis occurs in the cytoplasm. Its educt acetyl-CoA is generated from citrate, as the latter can be exported from the mitochondrion, whereas acetyl-CoA itself cannot (Fig. 1). Citrate can be derived from either glutamine through transformation to  $\alpha$ -ketoglutarate and reductive carboxylation or glucose through its mitochondrial production of acetyl-CoA through pyruvate dehydrogenase (Fig. 1). This initially removes a molecule of oxaloacetate from the TCA cycle, which is regenerated from citrate in the cytoplasm and the oxaloacetate is returned to the mitochondrion in the form of malate (Fig. 1). Additionally, glucose also contributes to triglyceride production through the production of glycerol-3-phosphate from the glycolytic intermediate dihydroxyacetone phosphate. However, some cancer cells do not produce lipids, but  $\beta$ -oxidize fatty



lipogenesis, and protein synthesis [12]. Enhanced glycolysis is also partly due to non-hypoxic increase in hypoxia-inducible factor 1 $\alpha$  (HIF-1 $\alpha$ ) downstream of mTORC1.

Constitutively active PI3K signaling can also occur through loss-of-function mutations in phosphatase and tensin homolog (PTEN), a PI3K inhibitor and major tumor suppressor, or direct activating mutations in PI3K. Mutations in PI3K pathway signaling components seem to be present in ~70 % of breast cancers (see chapter “[Breast cancer](#)”) and 50 % of colorectal cancers (see chapter “[Colorectal cancer](#)”), which is likely to lead to mTORC1-driven cell growth [13, 14]. mTORC1 can also be constitutively activated through activating mutations of Kirsten rat sarcoma viral oncogene homolog (KRAS) or rapidly accelerated fibrosarcoma (B-RAF) mutations or loss of the mTORC1 inhibitors liver kinase B1 (LKB1) or tuberous sclerosis complex (TSC) 1/2 (Fig. 2).

Transcription factors that play a central role in cancer can also control metabolism. c-Myc, one of the most commonly overexpressed genes in cancer, has been shown to enhance the Warburg effect and increase glutamine dependence of cells [15]. In addition to promoting mitochondrial biogenesis, c-Myc promotes the expression of glutaminase, the first gene in glutamine metabolism, and glutamine transporters to promote the uptake of glutamine [8, 15]. c-Myc promotes expression of many of the genes involved in glycolysis, as well as many of the transporters and enzymes involved in glucose uptake [15]. p53 is one of the most frequently mutated genes in cancer, acting as a tumor suppressor through its role in cell cycle arrest or apoptosis in response to DNA damage or other stress. p53 mutations have also been shown to alter metabolism controlling glycolysis, the PPP, oxidative respiration, and serine metabolism [16–19]. Due to rapid growth and poor tumor vascularization, many cancer cells have limited oxygen availability and thus activate the transcription factor HIF-1 $\alpha$  [20]. HIF-1 $\alpha$  controls transcription of key metabolic genes including glucose transporters and glycolytic enzymes to enhance the Warburg effect, optimizing tumor metabolism for the tumor microenvironment.

Mutations in some metabolic enzymes can cause the buildup of metabolites, termed oncometabolites, which are proposed to play a role in tumor progression. Mutated isocitrate dehydrogenase, a TCA cycle enzyme, creates an oncometabolite (2-hydroxyglutarate), which interferes with differentiation by causing epigenetic changes through the inhibition of  $\alpha$ -ketoglutarate-dependent regulation of chromatin modifications and DNA methylation [21]. Frequent mutations in the TCA cycle enzyme fumarate hydratase (also called fumarase) cause the accumulation of fumarate, proposed to disrupt metabolism and stabilize HIF-1 $\alpha$  [22]. However, much more remains to be understood about how the accumulation of oncometabolites in a cell can contribute to cancer development.

---

## Treatment of Cancer

Cancer treatment often focuses on the use of DNA-damaging radiation or cytotoxic chemotherapy agents (see chapter “[Breast cancer](#)”) that damage rapidly dividing cells by inhibiting DNA synthesis, transcription, and cell division. As metabolism plays a key role in DNA synthesis, antimetabolic therapies may sensitize cancer cells to cytotoxic chemotherapies. In turn, cytotoxic agents likely cause disruption of cancer metabolism.

The ideal cancer therapies target and kill cancer cells while sparing the noncancerous tissues around them. Classical therapies aim to target the deregulated signaling pathways leading to malignant growth and proliferation. For example, the ATP analogue sunitinib blocks several important receptor tyrosine kinases, which favor proliferation. Similarly, vemurafenib, a Raf inhibitor, targets the mitogen-activated protein kinase pathway to induce cancer cell death. As cancer cells exhibit altered metabolism compared to quiescent cells, cancer metabolism has generated interest as a potential therapeutic target [23], e.g., inhibiting aerobic glycolysis or glutamine metabolism may slow cancer growth [8]. A glucose analogue, 2-deoxyglucose, is used to inhibit glycolysis and thus hampers cell growth. Cancer metabolism-based therapy seeks to disrupt one or more of the numerous metabolic changes that occur in cancer to slow cancer cell

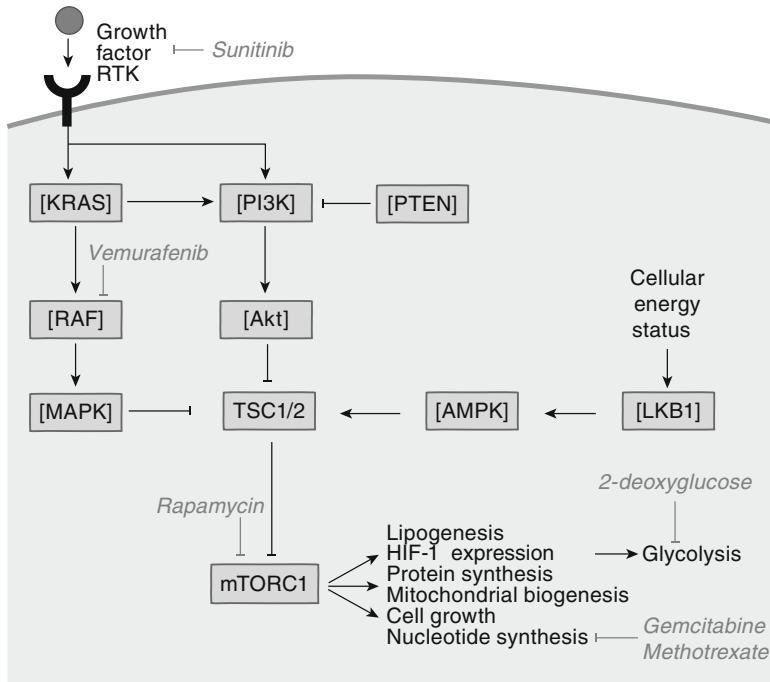

**Fig. 2** Cancer therapies target cancer metabolism and the pathways that control them. Commonly found activating mutations of many oncogenes such as receptor tyrosine kinases (*RTK*) and their downstream signaling factors phosphatidylinositol-3-kinase (*PI3K*), Kirsten rat sarcoma viral oncogene homolog (*KRAS*), protein kinase B (*Akt*), rapidly accelerated fibrosarcoma (*RAF*), mitogen-activated protein kinase (*MAPK*), or inactivating mutations of tumor suppressors such as phosphatase and tensin homolog (*PTEN*), tuberous sclerosis complex (*TSC*) 1/2, or liver

kinase B1 (*LKB1*) in cancer lead to mammalian target of rapamycin complex 1 (*mTORC1*) activation and downstream metabolic changes. Consequently, these represent targets of anticancer drugs. Activation of *mTORC1* is targeted at the level of *RTK* inhibition (e.g., sunitinib), *RAF* inhibition (vemurafenib), or direct inhibition of *mTORC1* (rapamycin). Additionally, drugs target *mTORC1*-regulated pathways such as glycolysis (2-deoxyglucose) and nucleotide synthesis (gemcitabine). *AMPK* AMP-activated protein kinase, *HIF-1*  $\alpha$  hypoxia-inducible factor 1 $\alpha$

growth, induce cancer cell death, or enhance sensitivity to other treatments. However, metabolic cancer therapies are complicated by the metabolic flexibility of cancer cells, the feedback loops, and the metabolic similarities between cancer cells and some proliferating cells. The first drugs to target cancer metabolism were antifolate drugs in the 1940s [24], giving rise to the commonly used antifolate drug methotrexate. Folate is an important donor of methyl groups during nucleotide synthesis. Other treatments, like the nucleoside analogue gemcitabine, also inhibit nucleotide synthesis. As glycolytic intermediate-derived glycine is a critical source of folate, anti-glycolytic therapy may sensitize cancer cells to antifolate drugs.

Other therapies propose to target master regulators of metabolism or mitochondrial function,

e.g., the anti-diabetes drug metformin (see chapter “[Diabetes mellitus](#)”), which inhibits mitochondrial function and indirectly activates the cellular energetic sensing AMP-dependent protein kinase, has anticancer effects. The first *mTORC* inhibitors (e.g., rapamycin itself) are now approved by the FDA [12] as anticancer drugs, with others moving toward the clinic.

### Influence of Treatment on Metabolism

Cytotoxic chemotherapeutic agents can have a wide array of side effects due to their effects on noncancerous cells, including organ damage, immune problems, gastrointestinal defects, hair

loss, fatigue, and cognitive alterations. Anticancer therapies have global metabolic effects in patients that are poorly understood. Many patients undergoing chemotherapy experience changes in weight and fat accumulation. While nausea and other side effects can cause weight loss in many cancers, women receiving adjuvant therapy (see chapter “[Breast cancer](#)”) often experience weight gain.

## Perspectives

Cancer cells undergo profound metabolic changes, allowing for rapid proliferation and cell maintenance in a hostile tumor microenvironment. While aerobic glycolysis can fuel biosynthetic pathways, glutamine can fuel the TCA cycle to provide energy and other cellular building blocks. Hence, enhanced understanding of changes in cancer metabolism and the mutations that cause them should provide a potential therapeutic avenue for treating cancer, and multiple antimetabolic drugs are in clinical trials. Novel approaches include inhibitors against oncogenic isocitrate dehydrogenase mutations [25, 26], glycolysis, and glutaminase. By linking recurrent genetic changes with alterations in metabolism, antimetabolic cancer drugs may even be tailored for personalized therapy.

## References

1. Ward PS, Thompson CB (2012) Metabolic reprogramming: a cancer hallmark even warburg did not anticipate. *Cancer Cell* 21(3):297–308, Epub 2012/03/24
2. Koppenol WH, Bounds PL, Dang CV (2011) Otto Warburg’s contributions to current concepts of cancer metabolism. *Nat Rev Cancer* 11(5):325–337, Epub 2011/04/22
3. Kelloff GJ, Hoffman JM, Johnson B, Scher HI, Siegel BA, Cheng EY et al (2005) Progress and promise of FDG-PET imaging for cancer patient management and oncologic drug development. *Clin Cancer Res* 11(8):2785–2808, Epub 2005/04/20
4. Riganti C, Gazzano E, Polimeni M, Aldieri E, Ghigo D (2012) The pentose phosphate pathway: an antioxidant defense and a crossroad in tumor cell fate. *Free Radic Biol Med* 53(3):421–436, Epub 2012/05/15
5. Possemato R, Marks KM, Shaul YD, Pacold ME, Kim D, Birsoy K et al (2011) Functional genomics reveal that the serine synthesis pathway is essential in breast cancer. *Nature* 476(7360):346–350, Epub 2011/07/16
6. Jain M, Nilsson R, Sharma S, Madhusudhan N, Kitami T, Souza AL et al (2012) Metabolite profiling identifies a key role for glycine in rapid cancer cell proliferation. *Science* 336(6084):1040–1044, Epub 2012/05/26
7. Wallace DC (2012) Mitochondria and cancer. *Nat Rev Cancer* 12(10):685–698, Epub 2012/09/25
8. Wise DR, Thompson CB (2010) Glutamine addiction: a new therapeutic target in cancer. *Trends Biochem Sci* 35(8):427–433, Epub 2010/06/24
9. Le A, Lane AN, Hamaker M, Bose S, Gouw A, Barbi J et al (2012) Glucose-independent glutamine metabolism via TCA cycling for proliferation and survival in B cells. *Cell Metab* 15(1):110–121, Epub 2012/01/10
10. Son J, Lyssiotis CA, Ying H, Wang X, Hua S, Ligorio M et al (2013) Glutamine supports pancreatic cancer growth through a KRAS-regulated metabolic pathway. *Nature* 496(7443):101–105, Epub 2013/03/29
11. Santos CR, Schulze A (2012) Lipid metabolism in cancer. *FEBS J* 279(15):2610–2623, Epub 2012/05/25
12. Laplante M, Sabatini DM (2012) mTOR signaling in growth control and disease. *Cell* 149(2):274–293, Epub 2012/04/17
13. Cancer Genome Atlas Network (2012) Comprehensive molecular characterization of human colon and rectal cancer. *Nature* 487(7407):330–337, Epub 2012/07/20
14. Cancer Genome Atlas Network (2012) Comprehensive molecular portraits of human breast tumours. *Nature* 490(7418):61–70, Epub 2012/09/25
15. Dang CV (2012) MYC on the path to cancer. *Cell* 149(1):22–35, Epub 2012/04/03
16. Bensaad K, Tsuruta A, Selak MA, Vidal MN, Nakano K, Bartrons R et al (2006) TIGAR, a p53-inducible regulator of glycolysis and apoptosis. *Cell* 126(1):107–120, Epub 2006/07/15
17. Hu W, Zhang C, Wu R, Sun Y, Levine A, Feng Z (2010) Glutaminase 2, a novel p53 target gene regulating energy metabolism and antioxidant function. *Proc Natl Acad Sci U S A* 107(16):7455–7460, Epub 2010/04/10
18. Jiang P, Du W, Wang X, Mancuso A, Gao X, Wu M et al (2011) p53 regulates biosynthesis through direct inactivation of glucose-6-phosphate dehydrogenase. *Nat Cell Biol* 13(3):310–316, Epub 2011/02/22
19. Maddocks OD, Berkers CR, Mason SM, Zheng L, Blyth K, Gottlieb E et al (2013) Serine starvation induces stress and p53-dependent metabolic remodeling in cancer cells. *Nature* 493(7433):542–546, Epub 2012/12/18
20. Semenza GL (2010) HIF-1: upstream and downstream of cancer metabolism. *Curr Opin Genet Dev* 20(1):51–56, Epub 2009/11/28
21. Lu C, Ward PS, Kapoor GS, Rohle D, Turcan S, Abdel-Wahab O et al (2012) IDH mutation impairs histone demethylation and results in a block to cell differentiation. *Nature* 483(7390):474–478, Epub 2012/02/22

22. Isaacs JS, Jung YJ, Mole DR, Lee S, Torres-Cabala C, Chung YL et al (2005) HIF overexpression correlates with biallelic loss of fumarate hydratase in renal cancer: novel role of fumarate in regulation of HIF stability. *Cancer Cell* 8(2):143–153, Epub 2005/08/16
23. Tennant DA, Duran RV, Gottlieb E (2010) Targeting metabolic transformation for cancer therapy. *Nat Rev Cancer* 10(4):267–277, Epub 2010/03/20
24. Farber S, Diamond LK (1948) Temporary remissions in acute leukemia in children produced by folic acid antagonist, 4-aminopteroyl-glutamic acid. *N Engl J Med* 238(23):787–793, Epub 1948/06/03
25. Rohle D, Popovici-Muller J, Palaskas N, Turcan S, Grommes C, Campos C et al (2013) An inhibitor of mutant IDH1 delays growth and promotes differentiation of glioma cells. *Science* 340:626–630
26. Wang F, Travins J, Delabarre B, Penard-Lacronique V, Schalm S, Hansen E et al (2013) Targeted inhibition of mutant IDH2 in leukemia cells induces cellular differentiation. *Science* 340:622–626

# Index

## A

- Abdominal obesity, 199, 339, 342  
A $\beta$  plaques, 36, 38  
Absorption, 61, 84, 94–97, 123–128, 133, 138–141,  
144–146, 149, 157, 160–162, 167, 168, 178,  
186, 195, 286, 298, 300, 347, 349, 359, 364  
ACE inhibitor, 252, 253, 255, 340, 342  
Acetylcholine, 7, 38, 132, 140, 224, 237  
Acetylcholinesterase inhibitors, 38, 55  
Acid-base homeostasis, 175, 333–337  
Acidosis, 138, 168, 211, 212, 244, 268, 269, 283,  
346, 347, 349, 363, 364  
Activation symbol, 2  
Acute infectious gastroenteritis, 137, 138, 141  
Acute respiratory distress syndrome  
(ARDS), 227, 229  
Adaptive immune system, 127, 305  
Adenosine, 7, 24–27, 32, 240, 335  
Adipocyte, 9, 14, 95, 164, 165, 191–196, 200–202,  
240, 285, 321, 339  
Adipocyte-derived cytokines or factors (adipokines),  
164, 165, 193, 194, 200, 201, 261, 262,  
265, 285, 321, 382, 383  
Adipogenesis, 193, 195  
Adipokine, 164, 165, 193, 194, 200, 201, 261, 262,  
265, 285, 321, 382, 383  
Adiponectin, 165, 193–195, 200–202, 342  
Adipose tissue, 76, 164, 165, 191–196, 200, 261,  
262, 265, 297, 314, 316, 321, 339, 369, 375,  
381–383  
Adjuvant therapy, 153, 382, 398  
Adrenergic  $\beta$ -1 receptor, 340, 342  
Adrenocorticotrophic hormone  
(ACTH), 12, 13, 116, 320  
 $\beta$ 1-Adrenoreceptor, 253–255  
Adult-onset diabetes. *See* Type 2 diabetes mellitus  
(T2DM)  
Advanced glycation end products (AGEs),  
68, 166, 263, 268  
Adventitia, 207, 208, 261, 262, 274  
Aeroallergens, 216, 326  
Aerobic glycolysis, 309, 393–398  
Aerosolization, 228  
Aerosolized vasodilators, 229  
Age-related macular degeneration  
(AMD), 67–72  
anti-VEGF therapy, treatment of exudative  
AMD, 70  
influence of treatment on metabolism, 70  
introduction to AMD, 67  
nutritional supplementation to prevent development  
of late-stage AMD, 70  
pathophysiology of AMD and metabolic  
alterations, 67–68  
perspectives, 70–71  
treatment, 68–70  
Aging process, 67, 68  
Albumin synthesis, 182  
Alcohol, 286, 299, 339, 352  
Aldosterone, 116, 166, 182–185, 251–255, 263,  
332–337, 339–341, 345, 346, 374  
Aldosterone blocker, 255, 340  
Allergen, 145, 215–217, 323–327  
Allergen-specific immunotherapy, 326, 327  
Allergies, 323–328  
influence of treatment, metabolism and  
consequences for patients, 326–327  
introduction to allergies, 323  
pathophysiology of allergies and metabolic  
alterations, 323–325  
perspectives, 327–328  
treatment, 326  
Allopurinol, 353, 354, 362, 364  
Alternative complement pathway, 68  
Alveolar sack, 208  
Alveolar wall, 208–210, 212, 223  
Alzheimer's disease (AD), 35–39  
implications for treatment and influence  
of treatment on metabolism, 38–39  
introduction to Alzheimer's disease, 35–36  
pathophysiology of Alzheimer's disease and  
metabolic alterations, 36–38  
perspectives, 39  
Amantadine, 31  
Ammonia toxicity, 178  
Amylase, 160  
Amyloid pathology, 36, 38  
Amyloid precursor protein (APP), 36, 37, 53  
Anaerobic glycolysis, 48, 50, 212, 238, 284  
Anakinra, 111, 354  
Analgesic, 44, 108, 110, 147, 291, 359  
Anaphylaxis, 323, 325–327, 353



- Anapyrexia, 315
- Androgen, 116, 117, 137, 194, 369–376, 385–389  
 receptor, 375, 385, 387, 388  
 synthesis inhibition, 386, 388
- Androgen deprivation therapy (ADT), 386, 387
- Androgen receptor (AR) antagonist, 386, 387, 389
- Andropause, 375
- Anemia, 127, 131, 222, 282–286, 289–293, 335, 345–350, 383
- Angiogenesis, 69, 166, 181, 193, 380, 381
- Angiotensin-converting enzyme (ACE), 212, 263, 335, 339, 341, 349
- Angiotensin-converting enzyme (ACE) inhibitor, 246, 247, 253, 340, 341, 349
- Angiotensin II (ATII), 182, 194, 212, 252–255, 263, 333, 335, 336, 339, 346, 374
- Angiotensin receptor blockers, 254, 340, 341, 349
- Animal fat, 149, 150, 152
- Antacids, 132, 133, 147
- Anterior pituitary, 8, 9, 13, 19, 370, 371
- Anti-amyloid therapy, 38–39
- Anti-androgen withdrawal response, 387
- Antibiotic treatment, 140, 229, 365
- Antibody, 305–307
- Anticaries therapy, 91
- Anticholinergic drugs, 31
- Anticonvulsant, 25–27
- Anti-cytokine therapy, 109, 111
- Antidepressant, 12, 14, 44, 147
- Antidiabetic drugs, 15, 166–168
- Antidiuretic hormone (ADH, vasopressin), 8, 182, 183, 334, 336, 371
- Antiemetic, 138, 140
- Antiepileptic drugs (AED), 24, 25, 44
- Antihistamines, 146, 147, 326, 327
- Antihypertensive medications, 269, 270, 340, 341, 349
- Antimicrobial, 124, 131, 151, 182, 210, 228, 230, 305, 309, 310, 321, 359
- Anti-osteoporotic drugs, 96
- Antioxidant, 8, 14, 32, 38, 51, 55, 222, 225, 241, 270, 276, 290, 394
- Antipsychotic, 18–20
- Antipyretic drugs, 314, 316, 317
- Antithrombotic, 230, 240, 264
- Anti-VEGF therapy, 69–71
- Apolipoprotein, 36–38, 295–298
- Apolipoprotein E4 (ApoE4), 36
- Apoptosis, 54, 83, 95, 97, 111, 152, 164, 165, 176, 241, 244, 247, 252, 253, 267, 274, 297, 306, 309, 310, 324, 325, 380–382, 386, 396
- APP metabolism, 37–38
- Aquaporin, 333, 334, 337
- Aqueous humor, 60, 61, 73, 75
- Aromatase, 116, 117, 370–372, 375, 381, 382
- Arrow, 2
- Arrowhead, 2
- Arterial hypoxemia, 228
- Arterial vasodilator, 342
- Arteriolar resistance, 335
- Artery, 173, 174, 208, 211, 235, 236, 243, 244, 246–248, 255, 261, 268, 283, 298, 331–333
- Articular cartilage, 101, 102, 107, 108, 116
- Ascites, 182–185
- Ascorbic acid, 348, 362, 363, 365
- Aspirin, 130–132, 153, 314, 316, 317, 352
- Asthma, 215–219  
 introduction to asthma, 215  
 pathophysiology of asthma and metabolic alterations, 216  
 perspectives, 218  
 treatment of asthma and airway inflammation, 216–218
- Astrocyte, 6, 7, 23, 24, 37, 49, 50, 52, 54, 184, 262, 269
- Astrocyte dysfunction, 49
- Astrocytic gluconeogenesis, 50
- Astrogliosis, 24
- Asymptomatic bacteriuria (ASB), 357
- Atenolol, 44
- Atheromatous plaque, 202, 243–244, 247, 248
- Atherosclerosis, 166, 194, 201, 202, 243, 265, 297
- Atherosclerotic heart disease, 243–249  
 antianginal treatment and influence of treatment on cardiac metabolism, 245–246  
 atherosclerotic plaque formation and myocardial metabolic changes, 243–244  
 coronary heart disease, 243  
 introduction to atherosclerotic heart disease, 243  
 myocardial ischemia and heart metabolism, 244–245  
 perspectives, 248  
 pharmacological treatment of angina pectoris, 246–248
- ATP-sensitive K<sup>+</sup> channels, 158, 159
- Atrial natriuretic factor (ANF), 336
- Atrial natriuretic peptide (ANP), 336
- Atrioventricular node (AV node), 236
- Atrium, 235
- Autoimmune disease, 47, 55, 115, 117, 164, 182, 310, 374
- Autonomic nervous system, 11–13, 74, 320
- B**
- Bacteremia, 319
- Bacteria, 82, 87, 90, 91, 123–125, 127, 133, 137–141, 144–148, 150–152, 181–186, 210, 222, 228, 229, 286, 305, 308, 314–316, 348, 357–360, 362, 365
- Bacterial flora, 137, 140, 141
- Bacterial peritonitis, 184, 185
- Bacterial translocation, 183–184, 228
- Baroreceptor activation, 342
- Basal ganglia, 5, 18, 29, 30
- Basophil, 216, 217, 283, 324–327
- B-cell, 158, 165, 217, 223, 307, 324, 327
- β-blocker, 44, 75, 76, 147, 184, 185, 246, 247, 252–255, 340–342, 349
- β-cell, 14, 15, 20, 127, 157–159, 161, 162, 164–168
- β-cell dysfunction, 164, 165
- β-galactosidase, 147

- $\beta$ -hydroxybutyrate, 25, 50  
 $\beta$ -interferons, 51  
 Bile acid, 124, 125, 128, 132, 150, 151, 173–178, 182, 296, 301  
 Bile acid sequestering agent, 301  
 Biodegradable stents, 248  
 Biofilm, 87, 88, 90  
 Bisoprolol, 44  
 Bladder infection, 357  
 Bladder remodeling, 358  
 Bleeding, 64, 70, 127, 129–133, 153, 184, 185, 264, 267, 269, 270, 273, 275, 316  
 Blindness, 64, 67, 73, 74, 158  
 Blood, 281–287  
   the anaerobic glycolytic (Embden-Meyerhof) pathway, 284  
   anatomy and physiology of blood, 281  
   blood-specific metabolic/molecular pathways and processes, 281  
   buffering and homeostasis, 283  
   carbon dioxide transport, 282  
   cell, 30, 74, 84, 267, 281, 282, 284, 285, 290, 321, 335, 383  
   coagulation pathway and anticoagulant properties, 283  
   final remarks, 286  
   flow, 13, 48, 50, 71, 74, 75, 130, 132, 166, 186, 209, 228, 229, 235, 243–246, 261–262, 267–270, 290, 331, 335, 342  
   glucose level, 64, 76, 158, 160, 161, 163, 166–168, 270  
   hormonal transport for regulation of whole body metabolism, 283  
   iron transport, 283  
   leukocytes, 283  
   lipoprotein metabolism, 284  
   metabolites  
     of the blood affecting other tissues, 284–286  
     of the blood affecting the blood itself, 284  
     of other tissues affecting the blood, 286  
   oxygen transport, 281–282  
   the pentose phosphate shunt, 284  
   plasma, 30, 60, 84, 182, 263, 282  
   pressure, 64, 74–76, 110, 178, 181, 182, 184, 199, 211–213, 235, 240, 246, 255, 261–263, 269, 270, 273, 299, 326, 335–337, 339, 346, 354, 374  
   stasis, 273–275  
   transfusion, 291  
 Blood-brain barrier (BBB), 6, 30, 51, 63, 183, 184, 262, 267  
 Blood-retinal barrier, 60, 62, 63  
 Blood vessels, 261–266  
   anatomy and physiology of blood vessels, 261–263  
   factors from other tissues affecting conduit and resistance vessels, 265  
   final remarks, 265  
   paracrine signals acting within the vessel, 263  
   vascular factors affecting other tissues, 263–265  
 Body mass index (BMI), 14, 15, 107, 108, 199, 339, 340, 385  
 Bone, 81–85  
   anatomy and physiology of teeth and bone, 81  
   bone and tooth, roles in calcium–phosphate homeostasis, 84–85  
   bone growth, 81–82  
   bone remodeling, 83–84  
   calcium and phosphate metabolism and physiological reactions in bone and tooth, 83  
   final remarks, 85  
 Bone formation, 82–84, 93–97, 102  
 Bone mineral density (BMD), 93, 95, 96, 183, 386  
 Bone resorption, 82–85, 93–97, 102, 111, 335  
 Bradykinesia, 29  
 Brain, 5–10  
   anatomy and physiology of the brain, 5–6  
   brain-specific metabolic/molecular pathways and processes, 6–7  
   final remarks, 9  
   metabolites  
     affecting other tissues, 8–9  
     of the brain affecting itself, 8  
     of other tissues affecting the brain, 9  
 Branched chain fatty acid (BCFA), 150, 151  
 Breast, 145, 184, 195, 297, 369, 371, 372, 374–376, 379, 381, 387  
 Breast cancer, 379–384  
   anatomy and development of the mammary gland, 379  
   introduction to breast cancer (BC), 379  
   pathophysiology of BC, 380–382  
   perspectives, 383  
   treatment, 382–383  
 Breathing, 44, 207, 209–213, 215, 374  
 Bronchiole, 207–209, 222  
 Bronchiolitis, 221  
 Bronchitis, 221, 223  
 Bronchoalveolar lavage, 227  
 Bronchodilation, 210, 212, 224  
 Brown adipose tissue (BAT), 193, 314, 316  
 Bruch's membrane, 63, 67, 68  
 Buffering, 24, 129, 283, 316  
 Butyrate, 123, 125, 151, 152  
 Bypass surgery, 246  
**C**  
 Cachexia, 241, 315–316  
 Calcidiol, 84, 94, 95, 117, 182, 335, 336  
 Calcimimetic agents, 349  
 Calcitonin, 43, 54, 55, 111, 181, 183, 228  
 Calcitonin gene-related peptide (CGRP), 43–45, 181, 183  
 Calcitriol, 84, 85, 94, 102, 117, 335–336, 346, 347  
 Calcium channel blocker, 44, 246, 340, 341  
 Calcium dobesilate, 276  
 Calcium metabolism, 84, 336  
 Calcium oxalate, 361, 363, 364  
 Calcium phosphate, 81, 84, 88, 91, 263, 361–363  
 Calcium–phosphate homeostasis, 84

- Calcium stones, 361, 364
- Cancer, 393–399
  - cancer metabolism and possible outcomes, 393
  - changes in metabolism, 393–395
  - common mutations affecting metabolism, 395–396
  - influence of treatment on metabolism, 397–398
  - introduction to cancer, 393
  - metabolism, 393, 395–398
  - perspectives, 398
  - screening, 152
  - treatment, 396–397
- Capillary, 63, 74, 157, 208, 209, 235, 236, 262, 264, 275, 276, 295–297, 331, 332
- Capillary endothelial cell, 235
- Carbon dioxide (CO<sub>2</sub>), 125, 151, 207, 209–213, 230, 238, 281–283, 285, 333, 334, 365, 374
- Cardiac ATP generation, 237–238
- Cardiac cycle, 235
- Cardiac muscle contraction, 236
- Cardiac myocyte (CM), 235, 247, 252, 253
- Cardiac remodeling, 246, 252, 254
- Cardiac substrate metabolism, 238
- Cardiovascular disease (CVD), 11, 32, 96, 166, 185, 191, 196, 199, 200–202, 298, 339, 345–348, 373–375
- Caries, 81, 84, 85, 87–91
- Cartilage, 81, 82, 85, 101–103, 105, 107–109, 111, 116, 208, 209
  - catabolism and anabolism, 111
  - edema, 108
  - metabolism, 85
- Castration resistant prostate cancer, 386, 388
- Ca<sup>2+</sup> supplement, 95, 349, 364
- Cation transport, 290
- Ca<sup>2+</sup> transient, 237, 254
- Cellular immune response, 305
- Ceramide, 147, 178, 216, 241
- Cerebral cortex, 5, 6, 63
- Cerebral edema, 267, 278
- Cerebral hyperglycolytic lactate production, 268
- Cerebrospinal fluid, 35, 36, 38, 47–49
- Cerebrovascular, 141, 267
- Chemokine, 193–195, 216, 222, 223, 244, 269, 306–308
- Chemoprevention, 152–153
- Chemotherapy, 153, 380, 382, 383, 396, 398
- Cholangiocyte, 173, 176, 177
- Cholecystokinin (CCK), 125, 160
- Cholestatic liver disease, 182
- Cholesterol, 30, 117, 151, 160, 173, 175–177, 182, 199–202, 243–248, 262, 267, 269, 270, 285, 295–301, 369, 370, 382, 385
- Chondrocyte, 81, 101, 102, 105, 107–109, 111
- Chondroitin sulfate, 110
- Choroid, 50, 59, 60, 62–64, 67, 68, 71
- Chromosomal translocation, 53, 54
- Chronic hyperglycemia, 163, 166
- Chronic inflammation, 14, 105, 119, 128, 151, 165, 194, 215, 217, 222, 223, 383
- Chronic kidney disease (CKD)
  - acid-base and electrolyte disturbances, 346–347
  - acid-base and electrolytes, 349–350
  - anemia, 347–349
  - bone and mineral metabolism, 349
  - cardiovascular disease, 345–346
  - introduction to CKD, 345–350
  - introduction to treatment and influence on metabolism, 348
  - mineral and bone disorders, 346
  - perspectives, 350
  - risk of CVD, 349
  - uremia, 348, 350
- Chronic obstructive pulmonary disease (COPD), 221–226
  - corticosteroids, 225
  - introduction to COPD, 221
  - introduction to treatment and influence on metabolism, 224
  - long-acting bronchodilators, 224–225
  - other therapies, 225
  - pathophysiology of COPD and metabolic alterations, 222–224
  - perspectives, 225
  - phosphodiesterase-4 inhibitors, 225
  - smoking cessation, 224
- Chronic stable angina pectoris (CSA), 243, 245, 246, 248
- Chronic venous insufficiency, 273
- Chylomicron, 295–300
- Cilia, 60, 74, 207, 208, 210, 228
- Circadian rhythm, 64, 115, 117–119
- Circadian undulation, 115
- Circannual supplementation therapy, 119
- Circulating androgen, 371, 372, 375, 385, 386
- Cirrhosis, 181–187
  - ascites and spontaneous bacterial peritonitis, 184–185
  - conclusions and perspectives, 186
  - hepatic encephalopathy, 186
  - hepatic syndrome, 186
  - hepatorenal syndrome, 186
  - introduction to cirrhosis, 181
  - pathophysiology of cirrhosis and metabolic alterations, 181
  - portal hypertension, 181–182, 184
  - reduced parenchymal metabolic function, 182–184
  - treatment of cirrhosis and related complications, 184
- Cis-retinal, 61–63
- Citrate, 30, 48, 133, 238, 239, 362, 364, 365, 394–398
- Clinically isolated syndrome (CIS), 47
- Cluster headache (CH), 41–45
  - introduction to migraine and cluster headache, 41
  - pathophysiology of head pain and the trigeminovascular system, 42–43
  - perspectives, 45
  - prophylactic treatment of CH, 44–45
  - treatment, 43–44
- Coagulation, 166, 230, 264, 282, 283, 286, 325
- Coenzyme Q10 supplementation, 55
- Cognitive behavioral therapy, 146, 147
- Cognitive impairment, 17, 20, 27, 29, 36, 38, 39
- Colchicine, 353, 354
- Collagen, 59, 81, 83, 101–104, 107, 111, 181, 244, 252, 255, 261, 262, 269, 274, 275, 297
- Collecting duct, 331–334, 337

- Colon, 123–128, 137, 143–145, 149–153, 160, 349  
 Colon cancer, 149, 150  
 Colonic microbiota, 150, 151  
 Colorectal cancer (CRC), 149–154  
   cancer screening and chemoprevention, 152–153  
   dietary modifications for minimizing risk of  
     colorectal cancer, 152  
   introduction to CRC, 149  
   pathophysiologic role of the colonic  
     microbiota, 150–152  
   pathophysiology of CRC, 149–150  
   perspectives, 153  
   prevention, 152  
   treatment and influence on metabolism, 152  
   treatment of CRC, 153  
 Community-acquired pneumonia (CAP), 227–231  
   influence of treatment on metabolism and  
     consequences for patients, 229–230  
   introduction to CAP, 227–228  
   pathophysiology of CAP, 228  
   perspectives, 230–231  
   treatment, 229  
 Complement system, 67, 68, 71, 305  
 Compression hosiery, 275  
 Compulsive eating, 31  
 Computer tomography (CT), 35, 363  
 Conduit and resistance vessels, 265  
 Contractile phenotype, 274  
 Core body temperature (CBT), 313  
 Coronary artery disease (CAD), 243, 246–248  
 Corticosteroids, 13, 14, 45, 51, 93, 108, 110, 116,  
   119, 147, 217, 218, 221, 224, 225, 230,  
   254, 354, 388  
 Corticotropin-releasing hormone (CRH), 12, 13, 116  
 Cortisol, 9, 13, 15, 115–118, 268, 269, 320, 321, 388  
 Cromolyn sodium, 326, 327  
 Crypt, 126, 152  
 Cyclic nucleotide-gated ion channel, 61  
 Cyclooxygenase (COX) inhibitor, 316  
 Cysteinyl leukotrienes, 325, 326  
 Cystine stone, 365  
 Cystinuria, 361, 363, 365  
 Cystitis, 357–358  
 Cytokine, 11–15, 17, 51, 83, 94, 95, 104, 105, 108, 109,  
   111, 115–118, 130, 134, 151, 164, 175, 176,  
   178, 182, 183, 193–195, 200, 202, 216, 217,  
   222, 223, 225, 229, 241, 244, 252, 253, 264,  
   265, 267, 269, 274, 275, 286, 290, 306, 308,  
   309, 314, 315, 320, 321, 324, 325, 327  
 Cytotoxic T cell, 222, 223, 305, 306, 308, 310
- D**
- Danger-associated molecular pattern (DAMP),  
   308–310  
 Dantrolene, 314, 316  
 Darbepoetin- $\alpha$ , 349  
 Dashed arrow, 2  
 Deep brain stimulation, 31, 32, 45  
 Degranulation, 325, 327  
 Dehydration, 138–141, 185, 186, 289, 291, 292  
 De Ley-Doudoroff pathway, 143  
 Dementia, 31, 35, 39, 54  
 Demineralisation, 90  
 Demyelination, 47–50  
 Dendritic cell, 208, 216, 217, 222, 244, 306–309  
 Dendritic spine pathology, 55  
 Dense capillary network, 208, 209  
 Dental caries, 87–92  
   influence of treatment on metabolism, 90–91  
   introduction to dental caries, 87  
   pathophysiology of dental caries and metabolic  
     alterations, 87–90  
   perspectives, 91  
   treatment and implications for patients, 90  
 Dentin, 81–84, 87, 89  
 2-Deoxyglucose, 36, 394, 397  
 Depolarization, 6, 7, 61, 158, 159, 213, 236, 237, 255  
 Depression, 11–16  
 Detoxification, 176, 281, 333, 337, 394  
 Dexamethasone, 45  
 Diabetes mellitus, 163–169  
   complications, 166  
   diabetes treatment and its influence  
     on metabolism, 166–168  
   introduction to diabetes mellitus, 163  
   pathophysiology of diabetes mellitus and  
     metabolic alterations, 164  
   perspectives, 168  
   type 1 diabetes, 164  
   type 2 diabetes, 164–166  
 Dialysis, 348–350, 359  
 Diarrhea, 41, 111, 125, 128, 133, 137–141, 143–145,  
   185, 224, 225, 362, 383  
 Diastole, 235, 254, 261  
 Diet, 9, 15, 25, 26, 68, 84, 90, 91, 94, 95, 117, 123–125,  
   146–152, 160, 167, 184–186, 196, 215, 284,  
   298–300, 339, 340, 348, 349, 351–353,  
   361–365, 383  
 Dietary fiber, 150, 152  
 Dietary heme, 152  
 Dietary modification, 152  
 Dietary restriction, 146, 340, 363  
 Digestion, 123–126, 130, 139, 141, 146, 157, 160,  
   161, 167, 173, 178  
 Digestive enzyme, 124, 157, 158, 160, 161  
 Digitalis, 252–254  
 Dihydropyridine, 340  
 Dihydrotestosterone, 369–372, 374, 375  
 Dihydroxy acid leukotriene, 325  
 Dimethyl fumarate, 51  
 Dipeptidyl peptidase-4 (DPP-4), 167  
 Disease-modifying osteoarthritis (OA) drugs  
   (DMOADs), 107, 109, 111  
 Disrupted in schizophrenia (DISC), 17  
 Distal renal tubular acidosis, 363, 364  
 Diuretic-induced diabetes, 342  
 Dopamine (DA), 7, 8, 11, 12, 17–20, 29–32, 146,  
   246, 247, 371  
   agonist, 31, 32  
   D2 receptor, 19, 20  
   oxidation, 30

- Dopaminergic function, 18  
Dopaminergic neuron, 9, 30  
Dotted arrow, 2  
Down syndrome (DS), 53–56  
    altered oxidative stress and energy metabolism  
    in DS, 53–55  
    introduction to DS, 53  
    pathophysiology of DS and metabolic  
    alterations, 53  
    perspectives, 55  
    treatment and its influence on metabolism, 55  
DPP-4 inhibitor, 167  
Drusen, 67, 68  
Duodenal bulb, 129, 130  
Duodenitis, 130  
Duodenoscopy, 129, 131  
Duodenum, 123–125, 129, 133, 138, 157, 158, 160, 182  
Dyslipidemia, 11, 14, 15, 194, 199–202, 245,  
269, 339, 386, 387
- E**  
Ebb phase, 319  
Edema, 42, 107, 108, 168, 178, 211, 251, 263,  
267, 269, 270, 275, 276, 283, 388  
Effector cell, 216, 305, 306  
Effector phase, 323–326  
Electrolyte  
    disturbances, 346–347  
    metabolism, 333, 337  
    solution, 140  
Emphysema, 221–223  
Enamel, 81–84, 87–91  
Endocardium, 236  
Endocrine pancreas, 157–162  
Endocrine therapy, 382  
Endothelial cell, 6, 49, 64, 68, 69, 173–176, 193, 201,  
235, 236, 261, 269, 274, 289, 290, 314, 315,  
325, 331, 333, 335, 348  
Endothelial dysfunction, 200, 202, 252  
Endothelial function, 246, 265  
Endothelium-derived hyperpolarization factor  
(EDHF), 263, 264  
Energy consumption, 24, 62  
Energy production disorder, 8  
Enterochromaffin cell, 132, 133  
Enterocyte, 123, 126, 139, 143, 144, 160, 295, 296, 298  
Enterotoxin, 128, 138, 139, 145  
Environmental etiology, 361  
Enzyme brackets, 2  
Eosinophil, 215–218, 222, 223, 225, 283, 324–327  
Epilepsy, 23–27  
    influence of treatment on metabolism, 25–26  
    introduction, 23  
    pathophysiology of epilepsy and metabolic  
    alterations, 23–25  
    perspectives, 26–27  
    treatment, 25  
Epinephrine, 7, 192, 246, 247, 265, 283, 326, 327  
Episodic and chronic cluster headache (CH), 42, 44  
Epoetin, 349  
Ergot, 31, 44  
Erythrocyte (red blood cell, RBC), 210, 212, 281, 282,  
285, 289, 290, 321, 335  
Erythropoietin (EPO), 212, 285, 286, 335, 336, 347, 349  
Estradiol, 9, 116, 369, 370, 373, 381, 387  
Estrogen, 94–97, 116, 117, 137, 194, 195, 265,  
369–376, 379–383, 385–389  
Estrogen receptor, 94, 96, 97, 117, 194, 265,  
374, 379, 381–383  
Estrogen response element (ERE), 380, 381  
Euler-Liljestrand mechanism, 212, 213  
Excitotoxicity, 38, 269  
Excretion, 84, 85, 94, 123, 168, 175–177, 179, 184, 212,  
235, 240, 281, 285, 286, 333, 334, 336, 337,  
340, 342, 346–349, 352–355, 363–365  
Exercise-induced asthma, 218  
Exocrine pancreas, 157–162  
Extracellular matrix (ECM), 81, 101, 102, 104, 107,  
109, 181, 228, 236, 244, 269, 274  
Extracorporeal shockwave lithotripsy, 363  
Eye, 59–65  
    anatomy and physiology of the eye, 59–60  
    final remarks, 64  
    metabolic and molecular pathways and  
    processes in the eye, 60  
    production of aqueous humor, 60–61  
    retinal metabolism, 61–63  
    retinal pigment epithelium role, 63  
    signals and metabolites affecting the function  
    of the eye, 64  
    signals from the eye affecting other organs and  
    tissues, 63–64
- F**  
Familial Alzheimer's disease (AD), 36  
Farnesoid X receptor (FXR), 176–178  
Fat tissue, 191–197  
    anatomy and physiology of fat tissue, 191  
    fat tissue-specific metabolic/molecular pathways  
    and processes, 191–193  
    final remarks, 196  
    metabolites  
    of the fat tissue affecting itself, 193–194  
    of fat tissue affecting other tissues, 194  
    of other tissues affecting fat tissue, 194–196  
Fatty acid, 13, 14, 25, 26, 30, 68, 90, 123–126, 150, 151,  
161, 164, 165, 174, 175, 192–195, 200, 209,  
215, 238–241, 244, 245, 247, 265, 268, 269,  
291, 295, 296, 301, 309, 310, 321, 364, 394  
Fatty acid translocase (FAT, CD36), 238, 239  
Fatty acyl-coenzyme A (FA-CoA), 192, 193  
Fatty streak, 244, 297  
Febuxostat, 353, 354  
Fenestra, 173, 262, 331, 333  
Fetal hemoglobin (HbF), 282, 289, 290  
Fever, 313–317  
    anapyrexia, the opposite of fever, 315  
    introduction to fever, 313  
    introduction to treatment and influence on  
    metabolism, 316

- mechanisms of fever, 314–315
  - metabolic changes during fever, 315–316
  - perspectives, 317
  - pyrogens, 315
  - Fibrinolysis, 195, 264, 283
  - Fibroblast, 103, 104, 175, 177, 178, 193, 208, 215–217, 225, 235, 236, 261, 274, 346, 347, 349
  - Fibroblast growth factor 23 (FGF23), 346, 347, 349
  - Fibrosis, 215, 217, 221–223, 241, 252, 255
  - Fick's law, 210
  - Fingolimod, 51
  - First-generation antipsychotic (FGA), 18–20
  - Flavonoid, 275–276, 383
  - Flow phase, 319
  - Fluid intake, 163, 363, 365
  - Flunarizine, 44
  - Foam cell, 201, 244, 297
  - Follicle stimulating hormone (FSH), 19, 117, 370, 371
  - Follicular dendritic cell, 306, 307
  - Fracture, 83, 93–97, 168, 386, 387
  - Fungemia, 319
  - Furosemide, 349
- G**
- $\gamma$ -aminobutyric acid (GABA), 7, 23–26, 30, 44
  - Gas exchange, 207, 209, 210, 212, 213, 223, 229, 261
  - Gastric acid, 123, 127, 129, 130, 132, 133, 160, 316, 326
  - Gastric inhibitory polypeptide (GIP), 160
  - Gastrin, 125, 130, 132, 133, 194, 285
  - Gastroenteritis, 137–142
    - bacteria, 137–139
    - influence of treatment on metabolism, 140–141
    - introduction to gastroenteritis, 137
    - parasites, 139
    - pathophysiology of gastroenteritis, 137
    - perspectives, 141
    - treatment, 139–140
    - viruses, 139
  - Gastrointestinal tract (GIT), 123–128
    - anatomy and physiology of the GIT, 123
    - colon, 127, 128
    - final remarks, 128
    - GIT-specific metabolic/molecular pathways and processes, 123
    - the large intestine: cecum, colon, and rectum, 125
    - metabolites
      - of the GIT affecting itself, 125–126
      - of the GIT affecting other tissues, 127
      - of other tissues and external factors affecting the GIT, 127
    - small intestine: duodenum, jejunum, and ileum, 124–125, 127–128
    - stomach, 123–124, 127–128
  - Generalized seizure, 23
  - Gene therapy, 27, 255, 292
  - Geographic atrophy, 67
  - Ghrelin, 9, 12, 14, 157, 195, 268
  - Giardia, 139, 140, 145, 148
  - Glatiramer acetate, 51
  - Glaucoma
    - closed-angle glaucoma, 73, 74
    - influence of treatment on metabolism, 75–76
    - introduction to glaucoma, 73–74
    - normal-tension glaucoma, 73
    - open-angle glaucoma, 74
    - pathophysiology of glaucoma and metabolic alterations, 74
    - perspectives, 76–77
  - Glia, 5, 6, 24, 37, 48, 50, 52, 269, 315
  - Gliosis, 18, 48, 73
  - Glomerular filtration rate (GFR), 178, 331, 336, 345–347
  - Glomerulus, 331–333, 335
  - Glucagon, 157–162, 175, 181, 194, 195, 321
  - Glucagon-like-peptide-1 (GLP-1), 160, 167, 177, 178
  - Glucocorticoids, 12, 13, 93, 116–119, 194, 195, 224, 225, 283, 326, 327, 370, 374
  - Glucocorticoid treatment, 118
  - Glucokinase, 158, 159
  - Gluconeogenesis, 12, 13, 50, 151, 161, 165, 174, 175, 183, 195, 201, 269, 285, 320, 321, 334
  - Glucosamine sulfate, 110
  - Glucose-dependent insulinotropic polypeptide (GIP), 160
  - Glucose-lowering treatment, 166
  - Glucose-stimulated insulin secretion (GSIS), 158–160
  - Glucose transport protein 1 (GLUT1), 158, 159
  - Glucose uptake, 12, 13, 158, 165, 192, 194, 201, 238, 269, 320, 393, 396
  - Glucotoxicity, 165, 166
  - Glutamate, 7, 17, 18, 24, 26, 30–32, 48, 175, 268, 269, 289, 290, 394, 395
  - Glutaminase, 175, 347, 394–396, 398
  - Glutathione (GSH), 51, 176, 178, 241, 284, 394
  - Glycogen, 12, 13, 49, 161, 174, 175, 178, 183, 238, 269, 285, 321
  - Glycogenesis, 161
  - Glycolysis, 48, 50, 62, 158, 159, 161, 174, 212, 237–239, 244, 245, 247, 268, 282, 284, 309, 393–398
  - Glycosylated hemoglobin (HbA1c), 166, 167
  - Goblet cell, 126, 127, 207–209
  - Gonad, 8, 19, 117, 369–371, 376
  - Gonadotropin releasing hormone (GnRH), 19, 117, 370, 371, 386, 388
  - Gout, 351–356
    - allopurinol, 354
    - febuxostat, 354
    - influence of treatment on metabolism and consequences for patients, 354
    - introduction to gout, 351
    - pathophysiology of gout and metabolic alterations, 351–353
    - perspectives, 355
    - treatment, 353–354
    - uricase, 355
    - uricosuric drugs, 354–355
  - Gouty inflammation, 352–355
  - G protein-coupled receptor (GPCR), 61, 151, 253, 336, 337
  - Granulosa cell, 369, 371, 372
  - Gut mucosa, 137, 139, 140, 151, 306

**H**

- HbA1c, 166, 167
- Heart, 235–242
  - anatomy and physiology of the heart, 235
  - cardiac muscle contraction, 236–237
  - cardiac substrate metabolism, 238
  - cellular composition, 235–236
  - final remarks, 241
  - heart-specific metabolic/molecular pathways and processes, 237–238
  - metabolites of
    - the heart affecting other tissues, 240–241
    - the heart affecting itself, 238–240
    - other tissues affecting the heart, 241
- Heart failure (HF), 251–257
  - influence of treatment on metabolism, 255
  - introduction to HF, 251
  - pathology of HF, 251–252
  - pathophysiology of HF and metabolic alterations, 252–254
  - perspectives, 255–256
  - treatment, 254–255
- Helicobacter pylori, 127, 129, 131
- Hematopoietic stem cell (HSC), 84, 291
- Hemodialysis, 350
- Hemodynamic disturbance, 273
- Hemoglobin, 163, 166, 167, 210, 212, 237, 240, 267, 281–286, 289–292, 335, 347, 349, 350
- Hemolysis, 284, 286, 289–292
- Hemorrhagic gastritis, 130
- Hemorrhagic stroke, 267–270, 291
- Hepatic encephalopathy (HE), 9, 178, 183–186
- Hepatic stellate cell, 173, 174
- Hepatocyte, 173, 174, 182, 183, 298
- Hepatocyte dysfunction, 183
- Hepatorenal reflex, 178
- Hepatorenal syndrome, 184–186
- Hering-Breuer inflation reflex, 212, 213
- High-density lipoprotein (HDL), 76, 199–202, 296–301, 348, 375
- Histamine, 11, 19, 20, 43, 132, 146, 324–327, 334
- Histamine H2 receptor antagonist (H2RA), 132, 133
- Hormone, 8, 9, 12–15, 19, 20, 53–55, 64, 83, 84, 94–96, 102, 111, 115–119, 123, 125, 127, 137, 146, 153, 157–162, 164, 173, 174, 178, 181–183, 193–195, 201, 262, 265, 268, 282, 283, 285, 286, 320, 321, 326, 333–337, 346, 347, 363, 369–376, 383, 385–388
- Hormone replacement therapy (HRT), 96, 153
- Hp<sup>+</sup> ulcer, 131, 134
- Hp<sup>-</sup> ulcer, 130, 131, 133, 134
- Human epidermal growth factor receptor 2 (HER2), 379
- Human leukocyte antigen (HLA), 164, 306
- Humoral immune responses, 305
- Hydrochloric acid (HCl), 123, 125
- Hydroxyapatite, 81, 83, 84, 87, 88, 91, 363
- Hydroxyurea (HU), 290, 291
- Hyperammonemia, 175, 178, 184, 185
- Hypercalciuria, 94, 362, 364
- Hypercapnia, 211
- Hyperdynamic circulation, 181, 182
- Hyperexcitability, 23, 24
- Hyperglycemia, 20, 119, 158, 160, 163–168, 200–202, 241, 267–270, 320, 321, 359
- Hyperinsulinemic phase, 164
- Hyperkalemia, 184, 185, 346, 347, 349
- Hyperlipidemia, 295–302
  - apolipoproteins, 297–298
  - bile acid sequestering agents, 301
  - chylomicrons, 295–297
  - dietary treatment, 300
  - drug treatment, 300
  - ezetimibe, 300–301
  - familial hypercholesterolemia, 299
  - high-density lipoprotein and reverse cholesterol transport, 297
  - introduction to hyperlipidemia, 295
  - low-density lipoprotein, 297
  - molecular mechanism and influence
    - on metabolism of the most common lipid-lowering drugs, 300
  - other lipid-lowering drugs, 301
  - perspectives, 301
  - physiological lipoprotein metabolism, 295–296
  - polygenic hyperlipidemias, 298–299
  - remnant removal disease, 299
  - secondary hyperlipidemia, 299–300
  - severe hypertriglyceridemia (HTG), 299
  - statins, 300
  - treatment, 300
  - various hyperlipidemias, molecular origin, and changes in metabolism, 298
  - very-low-density lipoprotein, 297
- Hyperoxaluria, 361–365
- Hyperphosphatemia, 347
- Hypertension, 339–344
  - influence of treatment on metabolism and consequences for patients, 342
  - introduction to hypertension, 339
  - pathophysiology of hypertension and metabolic alterations, 339
  - perspectives, 342–343
  - treatment, 340–342
- Hyperthermia, 267–268, 313–317, 319
- Hyperthyroidism, 94
- Hypertriglyceridemia (HTG), 202, 298, 299
- Hypertrophic bone changes, 107
- Hyperuricemia, 351–355, 363, 364
- Hypocitraturia, 362, 364
- Hypoinsulinemic phase, 164
- Hypolactasia, 144–148
- Hypometabolism, 319
- Hypothalamic-pituitary-adrenal (HPA) axis, 11–15, 90, 115–119, 269
- Hypothalamic-pituitary-gonadal (HPG) axis, 115–117, 370
- Hypothalamus, 5, 6, 8, 9, 12–14, 19, 20, 32, 43, 45, 64, 125, 194, 212, 268, 313, 314, 319, 320, 370–374, 388
- Hypothermia, 315, 319

Hypothyroidism, 53–55, 286, 299, 300  
 Hypotonia, 53, 55  
 Hypoxemia, 211, 212, 228, 347  
 Hypoxia, 17, 50, 200, 212, 213, 222, 228, 265, 273,  
 274, 276, 291, 335, 347, 393, 396, 397  
 Hypoxia inducible factor (HIF), 200, 212, 274,  
 347, 396, 397

## I

IL-1 $\beta$  receptor antagonist, 108, 111  
 Ileum, 123–125, 127, 128, 177, 178, 301  
 Immune system, 305–311  
   anatomy and physiology of the immune  
   system, 305–306  
   communication  
     between immune cells, 308–310  
     of immune cells with stromal cells, 310  
     of stromal cells with immune cells, 308  
   final remarks, 310  
   miscommunication in the immune system  
     as the basis of disease, 310  
   primary lymphoid tissues, 306  
   secondary lymphoid tissues, 306–307  
   specific pathways and metabolic processes  
     of the immune system, 306  
   tertiary lymphoid tissues, 308  
 Immunoglobulin (Ig), 47, 69, 74, 116, 174, 210, 217,  
 222, 228, 305, 324, 325, 327, 375  
 Immunoglobulin E (IgE), 217, 324, 325, 327  
 Immunological synapse, 308  
 Immunotherapy, 326–327, 382  
 Incretin, 127, 160, 167, 285  
 Incretin homologue, 168  
 Infarction, 230, 243, 248, 251, 252, 256,  
 267, 268, 312, 342  
 Inflammation, 11–15, 42, 43, 47, 49–51, 71, 75, 105,  
 107–111, 115–119, 125, 127, 128, 137, 139,  
 146, 147, 149–151, 164–166, 173, 181–184,  
 193, 194, 211, 215–217, 221–225, 228, 230,  
 231, 245, 252, 263, 265, 269, 273, 274, 290,  
 291, 300, 308, 313, 315, 319, 320, 324–327,  
 348, 352–355, 357, 358, 381, 383  
 Inflammatory attack, 51  
 Inflammatory bowel disease (IBD), 143–147  
 Inhaled corticosteroids, 217–218, 224  
 Inhaled toxic agent, 223  
 Innate immune system, 68, 127, 164, 216, 305, 323  
 Insulin, 157–161  
   resistance, 12–14, 18, 45, 74, 164–167, 194,  
   199–201, 241, 298, 319–321, 341, 348,  
   381, 383, 386  
   secretory granule, 158  
   therapy, 166, 167, 270  
 Insulin-like growth factor-1 (IGF-1), 94, 109, 149,  
 253, 320, 372, 381, 386  
 Integrin, 51, 139, 178, 290  
 Intensive care, 319  
 Intensive care unit (ICU), 227, 229, 230, 321  
 Intercritical phase, 351

Interferon, 13, 51, 54, 115, 116, 244, 308, 309, 324, 325  
 Interleukin, 13, 95, 108, 109, 115, 116, 118, 130, 164,  
 165, 175, 182, 193, 194, 216, 217, 222, 223,  
 229, 253, 265, 308, 309, 314, 315, 320, 324,  
 327, 352, 353, 382  
 Interleukin-6 (IL-6), 111, 115–119, 165, 195, 216, 223,  
 229, 230, 314, 315, 320, 324, 325, 382  
 Interleukin-1 $\beta$ , 109, 315, 352  
 Interleukin (IL)-1 inhibitor, 354, 355  
 International classification of diseases 10 (ICD-10), 1  
 Interstitial fibroblast, 235  
 Intima, 244, 261, 262, 274  
 Intoxication disorder, 8  
 Intraocular pressure (IOP), 60–64, 73–77  
 Intrapleural pressure, 209  
 Introduction, 1–2  
 Invasive bacterial strain, 137  
 Ionotropic receptor, 7  
 Ion pump, 9, 237, 247, 284  
 Iris, 59–61, 73  
 Iron, 30, 123, 124, 127, 150, 267, 282–286, 291, 349  
 Irritable bowel syndrome (IBS), 143–147  
 Ischemia, 50, 139, 185, 240, 243–247, 254–256, 357  
 Ischemic stroke, 267–270  
 Isotype switching, 325  
 Ivabradine, 246, 247, 255

## J

Jejunum, 123–125, 160  
 Joint formation, 101  
 Joints, 101–106  
   bone, 102  
   cartilage, 102–103  
   final remarks, 105  
   joint formation, 101–102  
   joints classification, 101  
   ligaments and tendons, 103–104  
   metabolites affecting the joints, 105  
   synovium, 104–105  
 Juvenile diabetes. *See* Type 1 diabetes

## K

KATP channel, 159, 240  
 Ketoacidosis, 166, 212  
 Ketogenesis, 175  
 Ketogenic diet, 9, 25–26  
 Ketone body, 26, 50, 175, 212  
 Ketosis, 26  
 Kidney, 331–337  
   anatomy and physiology of the kidneys, 331–333  
   final remarks, 337  
   kidney-specific metabolic and molecular pathways  
   and processes, 333–335  
   metabolites of  
     the kidney affecting other tissues, 335–336  
     the kidney affecting the kidney itself, 335  
     other tissues affecting the kidney, 336–337  
   transplantation, 348



- Kidney stones, 361–365  
 epidemiology and evaluation of  
 nephrolithiasis, 361–363  
 introduction to kidney stones, 361  
 perspectives, 365  
 treatment  
 of calcium-containing stones due to  
 hypocitraturia, 364  
 of calcium stones due to hypercalciuria, 364  
 of cystine stones, 365  
 of distal renal tubular acidosis, 364  
 general points, 363–364  
 of oxalate stones, 364  
 of struvite stones, 365  
 of uric-acid-containing stones, 364
- Kupffer cell, 173–176
- L**
- Lacrimal puncta, 59, 76  
 Lactase, 124, 125, 143–145, 147, 148  
 Lactate, 48–50, 161, 175, 238, 239, 241, 268,  
 275, 285, 309, 321, 334, 393–395  
 Lactation, 372, 379  
 Lactic acidosis, 168, 268, 269  
 Lactose intolerance, 143–148  
 influence of treatment on metabolism and  
 consequences for patients, 147  
 introduction to lactose intolerance, 143–145  
 pathophysiology of lactose intolerance  
 and metabolic alterations, 145–146  
 perspectives, 148  
 treatment, 146–147  
 Lactose sensitivity. *See* Lactose intolerance  
 Large intestine, 125, 137, 138, 144, 145, 147  
 L-dopa (L-3,4-hydroxyphenylalanine), 30–31  
 L-dopa-induced dyskinesia (LID), 31  
 Lean body mass, 319, 322, 387  
 Left ventricular dysfunction, 243, 244  
 Leg pain, 276  
 Lens, 60, 64  
 Leptin, 9, 12, 14, 20, 95, 164, 165,  
 193–195, 265, 268, 321  
 Leukocyte, 105, 164, 227, 240, 244, 261, 262, 265, 267,  
 275, 281–283, 289, 290, 306, 348, 358, 359  
 Leukocyte activation, 267, 275  
 Leukotrienes, 222, 223, 225, 324–327  
 Levetiracetam, 24, 25  
 Leydig cell, 369, 371, 372, 375  
 Lidocaine, 44  
 Lifestyle habits, 14, 93  
 Ligament, 101, 103, 104, 107  
 Limbic system, 5, 12  
 Lipid accumulation, 275  
 Lipid deposition, 243  
 Lipid droplet, 191–193  
 Lipid metabolite, 275  
 Lipid peroxidation, 53–55, 68, 69, 244, 269  
 Lipofuscin, 63, 67–69  
 Lipogenesis, 161, 164, 165, 174, 192, 193, 321, 396, 397  
 Lipolysis, 12, 13, 161, 192–194, 240, 269, 320, 321, 326  
 Lipopolysaccharide (LPS), 182, 183, 314, 315  
 Lipoprotein lipase (LPL), 12–14, 76, 192, 295, 296  
 Lipotoxicity, 164–166, 194, 195, 241  
 Lithium, 44  
 Liver, 173–179  
 anatomy and physiology of the liver, 173–174  
 bile formation and bile acid secretion, 175–176  
 detoxification, 176–178  
 final remarks, 179  
 liver and kidney dysfunction, 359  
 metabolites of other tissues affecting the liver, 178  
 metabolites of the liver affecting other tissues, 178  
 nutrient metabolism, 175  
 plasma protein synthesis, 174–175  
 urea synthesis and acid-base homeostasis, 175  
 Long-acting bronchodilators, 224  
 Loop of Henle, 331–335, 342, 349  
 Low-density lipoprotein (LDL), 76, 201, 243,  
 296–298, 348, 374  
 Lower airways, 207  
 Low molecular weight heparin (LMWH), 230  
 Low sodium diet, 185, 340  
 Lung, 207–213  
 anatomy and physiology of the lung, 207–209  
 breathing and pathologies, 211  
 breathing and treatment, 211  
 coordination with other organs, 212–213  
 final remarks, 213  
 function under extreme conditions, 211–212  
 gas exchange, 210  
 lung perfusion and usage of alveoli, 213  
 mechanism of breathing, 209  
 mucus production, 209–210  
 reflexes and internal regulation, 213  
 regulation of breathing, 210–211  
 surfactant production and function, 210  
 Luteinizing hormone (LH), 19, 117, 370, 371  
 Lymph node, 153, 305–307, 324  
 Lymphocyte, 13, 30, 48, 51, 116, 117, 164, 173, 244,  
 282, 283, 306, 310, 323–325  
 Lymphoid organ, 305–308, 310
- M**
- Macroautophagy, 309  
 Macrophage, 14, 48, 51, 102, 104, 105, 116, 117, 164,  
 173–175, 193, 194, 200, 201, 208, 209, 216,  
 217, 222, 223, 225, 243, 244, 274, 283, 284,  
 286, 290, 297, 305, 308, 314, 315, 324, 353  
 Macula densa, 331, 335  
 Macula lutea, 59, 60  
 Macular degeneration, 63, 64, 67, 69  
 Magnetic resonance imaging (MRI), 35, 36, 47, 48, 379,  
 Major depressive disorder, 11–16  
 association between depressive disorders  
 and MetS, 14  
 autonomic nervous system, 13  
 HPA axis, 13  
 inflammation, 13–14

- influence of treatment on metabolism, 15
  - introduction to major depressive disorders, 11
  - monoamine systems, 12–13
  - oxidative stress, 14
  - pathophysiology of depressive disorders and metabolic alterations, 11–12
  - peripheral hormones leptin and ghrelin, 14
  - perspectives, 15
  - treatment of depressive disorders, 14–15
  - Major histocompatibility complex (MHC), 48, 306, 307, 323, 348
  - Malabsorption, 94, 133, 138, 139, 141, 160, 162, 364
  - Maldigestion, 138, 139, 141, 145
  - Mammalian target of rapamycin (mTOR), 380, 381, 395, 397
  - Mammary gland, 144, 379, 380
  - Mast cell, 215–217, 261, 324–327
  - Matrix metalloproteinase (MMP), 108, 109, 222, 252, 267, 269, 274, 275, 380, 381
  - McDonald diagnostic criteria, 47
  - Media, 261–263, 274
  - Meglitinide, 167, 168
  - Melancholic depression, 11, 13
  - Memantine, 38, 39, 55
  - Memory cell, 306, 307
  - Menopause, 41, 94, 145, 299, 372–374, 379
  - Menstrual cycle, 117, 372
  - Mental disorder, 17
  - Metabolic acidosis, 138, 212, 346, 347, 349, 364
  - Metabolic switch, 244
  - Metabolic syndrome (MetS), 199–203
    - atherosclerosis, 202
    - dyslipidemia, 201
    - hypertension, 202
    - insulin resistance, 201
    - introduction to MetS, 199–200
    - pathophysiology of the MetS, 200
    - perspectives, 202
    - treatment of MetS and impact on metabolism, 202
    - visceral obesity, 200–201
  - Metabolic zonation, 174
  - Metabotropic receptor, 7
  - Metformin, 15, 166, 167, 383, 397
  - Methylglyoxal, 144–146
  - Methysergide, 44
  - Microbiome, 125, 127, 128, 151
  - MicroRNA, 255, 270
  - Migraine, 41–45
    - introduction to migraine and cluster headache, 41–42
    - pathophysiology of head pain and the trigeminovascular system, 42–43
    - perspectives, 45
    - prophylactic treatment of migraine, 44
    - treatment, 43–44
    - treatment of acute migraine, 44
  - Milk, 95, 125, 138, 140, 143, 145–147, 164, 215, 371, 375, 376, 379
  - Mineral and bone disorder, 346
  - Mitochondrial dysfunction, 8, 29, 30, 50, 53–55
  - Mitogen-activated protein kinase (MAPK), 109, 111, 119, 222, 380, 381, 396, 397
  - Mitoxantrone, 51
  - M3 muscarinic acetylcholine receptor, 15, 20
  - Monoamine oxidase-B (MAO-B) inhibitors, 31
  - Monoamine system, 12
  - Monocyte, 48, 50, 102, 164, 244, 274, 283, 297, 352
  - Monocyte chemotactic protein 1 (MCP-1), 193, 200, 222, 223, 265
  - Montelukast, 326, 327
  - Motor deficit, 31
  - Mucosal defense mechanism, 130, 132
  - Mucus, 123, 126, 127, 129, 130, 132, 134, 137, 207–210, 212, 215, 217, 221–225, 228, 325
    - hyperproduction, 215
    - plugging, 221
    - production, 134, 209, 212, 217, 325
  - Multidrug resistance, 176, 177, 229, 354
  - Multiple sclerosis (MS), 47–52
    - influence of treatment on metabolism, 51
    - introduction to MS, 47
    - introduction to treatment, 50–51
    - pathophysiology of MS and metabolic alterations, 48–50
    - perspectives, 52
  - Myc, 396
  - Myelin basic protein (MBP), 51
  - Myocardial hibernation, 244
  - Myocardial infarction, 230, 243, 248, 251, 252, 256, 316, 342
  - Myocardial ischemia, 243–247, 254
  - Myocardial reperfusion injury, 244, 247
  - Myocardium, 236, 237, 240, 241, 243, 244, 246, 248, 251, 252, 254
  - Myoinositol, 48, 275
  - Myosin light chain (MLC), 240, 263
  - Myostatin, 241
- N**
- N-acetylaspartate (NAA), 48
  - Natalizumab, 51
  - Natriuretic peptide, 240
  - Nausea, 38, 41, 44, 110, 137, 138, 224, 225, 374, 398
  - Nedocromil sodium, 326
  - Negative chronotropic agent, 246, 255
  - Neovascularization, 67, 68, 70
  - Nephrolithiasis, 361, 363
  - Nephrolithotomy, 363
  - Nephron, 331, 333, 334, 336, 346, 349
  - Neurodegeneration, 14, 19, 30, 47, 50, 51, 76
  - Neuroendocrine-immune (NEI) system, 115, 119
  - Neurofibrillary tangles, 35, 37, 38
  - Neurogenic inflammation, 43
  - Neuronal cell death, 37, 50, 269
  - Neuronal hyperexcitability, 23
  - Neuronal innervation, 160
  - Neurostimulation, 45
  - Neurotransmitter, 5–9, 11, 12, 15, 17, 18, 24–26, 29–31, 38, 43, 110, 146, 160, 224, 262, 372

- Nighttime modified-release glucocorticoid treatment, 118
- Nitrate, 246, 247
- Nitric oxide (NO), 7, 11, 12, 43, 48, 50, 109, 130, 182, 183, 218, 229, 240, 243, 247, 263, 264, 286, 290, 291, 335
- Nitrogen homeostasis, 184
- Nitroprusside test, 363
- N-methyl-D-aspartate (NMDA), 7, 24, 31, 38, 55
- Noninfectious gastroenteritis, 137
- Noninvasive bacteria, 138
- Noninvasive ventilation, 230
- Nonsteroidal anti-inflammatory drug (NSAID), 44, 108, 110, 129–131, 134, 146, 153, 182, 314, 316, 353, 354
- Non-T<sub>H</sub>2-type asthma, 216, 218
- Norepinephrine (NE), 7, 11, 12, 17, 237, 263–265, 335, 340
- Norovirus, 139
- Nutrient, 6, 50, 59, 70, 74, 83, 87, 104, 105, 123, 124, 127, 130, 139, 141, 157, 158, 160–162, 173, 175, 178, 195, 235, 261, 262, 265, 268, 281, 282, 285, 286, 359
- Nutrient metabolism, 175
- Nutritional supplementation, 70, 225
- O**
- Obesity, 11, 12, 14, 20, 36, 74, 75, 125, 149–153, 164–166, 191, 193, 196, 199–202, 216, 218, 245, 251, 256, 265, 273, 298, 299, 316, 339–342, 357–359, 375, 379, 381, 383
- Obesity-associated diseases, 196
- Octreotide, 44, 185
- Oligodendrocyte loss, 48
- Omalizumab, 327
- Orbit, 59
- Orthostatic hypotension, 342
- Osmotic diarrhea, 138
- Osteoarthritis (OA), 107–113
  - disease-modifying OA drugs, 111
  - introduction to OA, 107
  - non-pharmacological treatment, 110
  - OA management, 109
  - pathophysiology of OA, 107–109
  - perspectives, 111
  - pharmacological treatment, rapid-acting
    - symptomatic agents, 110
  - pharmacological treatment, slow-acting
    - symptomatic agents, 110–111
  - targeting cartilage catabolism and anabolism, 111
  - targeting subchondral bone remodeling, 111
  - targeting synovial inflammation by anti-cytokine therapy, 111
- Osteoblast, 81–85, 93–97, 102, 103
- Osteoclast, 82, 83, 85, 93–97, 102, 103, 111, 374, 375
- Osteocyte, 81–83, 96
- Osteopenia, 119, 183, 375
- Osteophyte formation, 107, 108
- Osteoporosis, 93–98
  - anti-osteoporosis drugs, 96
  - endocrine factors, 94–95
  - genetic and lifestyle habit risk factors and comorbidities, 93–94
  - immune factors, 95
  - introduction to osteoporosis, 93
  - nutritional factors, 95
  - nutrition and physical activity, 95–96
  - osteoporosis treatment and influence on bone metabolism, 95
  - pathogenesis of bone loss, 93
  - perspectives, 96
- Osteoprotegerin (OPG), 82, 83, 94, 102
- Ovary, 94, 369–373
- Oxalate, 348, 361–364
- Oxalate stone, 361, 364
- Oxidative and nitrosidative stress (O&NS), 12
- Oxidative phosphorylation, 49, 50, 62, 237, 244, 245, 309
- Oxidative stress, 8, 14, 18, 53, 54, 68, 70, 71, 73–75, 166, 182, 200, 222, 223, 245, 268, 348, 359
- Oxygen, 44, 50, 53, 59, 60, 62, 63, 74, 83, 174, 207–209, 212, 213, 222–225, 228, 229, 235, 237, 238, 240, 243–247, 251, 254, 255, 261–263, 267, 268, 270, 274, 281, 282, 284, 286, 289, 290, 393, 396
  - deprivation, 244, 267, 268
  - dissociation curve, 282, 286
  - transport, 212, 281, 282
- P**
- p53, 396
- Pain, 5, 41–45, 107–111, 129, 131–133, 137, 143–147, 191, 224, 225, 227, 243, 273, 275, 276, 291, 301, 308, 352–354, 357, 359, 386
- Pain-sensitive information, 42
- Pancreas, 157–162
  - anatomy and physiology of the pancreas, 157
  - final remarks, 161–162
  - metabolites of other tissues affecting the pancreas, 160
  - metabolites of the pancreas affecting itself, 159
  - metabolites of the pancreas affecting other tissues, 160–161
  - pancreas-specific metabolic pathways and processes, 157–159
- Pancreatic  $\beta$ -cell, 14, 20, 127, 164, 178
- Pancreatic islet (or islet of Langerhans), 157–159, 162, 164
- Paneth cell, 126, 127
- Pangastritis, 130
- Parasympathetic neuron, 13, 42, 43, 160, 194, 195, 210, 212, 237
- Parathyroid hormone (PTH), 84, 94, 102, 333, 335, 336, 346, 347, 363, 374
- Parathyroid hormone (PTH) analogue, 349
- Parenchymal cell (PC) hydration, 178
- Parkinson's disease (PD), 29–33
  - influence of treatment on metabolism and consequences for patients, 31–32
  - introduction to PD, 29

- introduction to treatment, 30–31
  - pathophysiology of PD and metabolic alterations, 29–30
  - perspectives, 32
  - Partial seizure, 23
  - Pathogen, 68, 127, 128, 137–141, 173, 212, 227–230, 305, 306, 308, 310, 319, 357
  - Pathogen-associated molecular pattern (PAMP), 186, 308, 309
  - Pentose phosphate pathway (PPP/PP shunt), 241, 282, 284, 394, 395
  - Pepsin, 123, 129, 130, 132
  - Peptic ulcer disease (PUD), 129–135
    - introduction to PUD, 129
    - pathophysiology of PUD and metabolic alterations, 130–131
    - perspectives, 134
    - therapy of  $Hp^+$  PUD, 133
    - therapy of  $Hp^-$  PUD, 133–134
    - treatment, 131–133
  - Percutaneous coronary intervention (PCI), 246
  - Perilipin, 192, 193
  - Periostin, 218
  - Peripheral androgen blockade, 386
  - Perivascular adipose tissue (PVAT), 261, 262, 265
  - Phosphatidylinositol-3-kinase (PI3K), 380, 381
  - Phosphodiesterase-4 (PDE4) inhibitors, 224, 225
  - Photopigment rhodopsin, 61
  - Photoreceptor cell, 59–64
  - Photosensitizer, 68
  - Pictet-Spengler reaction, 146
  - Pioglitazone, 167–168
  - Pit cell, 173
  - Pituitary, 5, 6, 8, 9, 11–13, 19, 94, 117, 320, 337, 370–376, 386, 388
  - Pizotifen, 44
  - Plaque biofilm metabolism, 87
  - Plasmapheresis, 51
  - Plasma protein synthesis, 174
  - Platelet (thrombocyte), 30, 110, 166, 240, 262–264, 270, 276, 281–283, 286, 290
  - Pleura, 207–209
  - Pneumonia. *See* Community-acquired pneumonia (CAP)
  - Podocyte, 331–333
  - Polydipsia, 163
  - Polyuria, 163, 359
  - Portal hypertension (PH), 181–185
  - Positron emission tomography (PET), 35, 36
  - Postcapillary venule, 262
  - Posterior (eye) chamber, 60, 61
  - Potassium citrate, 364, 365
  - Pregnancy, 41, 115, 163, 273, 300, 357–359, 369, 372–374, 376, 379
  - Preoptic area, 313, 314
  - Presenilin 1, 38
  - Primary hypertension, 339
  - Primary lymphoid tissue, 306
  - Primary progressive MS, 47
  - Pro-adrenomedullin, 231
  - Procalcitonin (PCT), 228, 229, 231
  - Proenzyme, 160
  - Progesterone, 9, 195, 359, 369, 370, 373, 380, 387, 388
  - Prolactin, 8, 18, 19, 371, 372, 376
  - Prostaglandin, 75, 111, 130, 133, 134, 140, 225, 263, 314–316, 324, 325, 335
  - Prostaglandin E<sub>2</sub> (PGE<sub>2</sub>), 130, 133, 225, 263, 314–316
  - Prostate cancer, 385–390
    - androgen deprivation therapy (ADT) and mitigating its adverse metabolic impact, 386
    - androgen synthesis inhibition, 388
    - castration-resistant prostate cancer and approaches to treat it, 386–388
    - intermittent ADT, 386
    - introduction to prostate cancer (PC), 385
    - pathophysiology of PC, 385
    - peripheral androgen blockade, 386
    - perspectives, 389
    - second generation androgen receptor (AR) antagonists, 389
  - Prostate gland, 375, 385
  - Protease, 109, 110, 165, 167, 221–223, 225, 269, 274, 282, 283, 310, 335, 353
  - Proteinopathy, 8, 35
  - Proteinuria, 300, 345
  - Proteoglycan, 101–103
  - Proteolytic fermentation, 150–152
  - Proton pump inhibitor (PPI), 131–133
  - Proximal tubule, 331–334, 336
  - Psychosis, 18, 20
  - Pulmonary hypertension, 291
  - Pulmonary rehabilitation, 225
  - Purine, 351–354
  - Pyelonephritis, 357–359
  - Pyrexia, 313
  - Pyridoxine, 128, 362, 364
  - Pyrogen, 314–316
- R**
- Randle cycle, 238
  - Ranolazine, 246, 247
  - Reabsorption, 84, 94, 95, 125, 140, 168, 182, 202, 301, 333, 334, 336, 337, 346, 349, 352–354, 364
  - Reactive microglia, 37
  - Reactive oxygen species (ROS), 8, 11, 12, 53, 63, 69, 130, 150, 151, 165, 178, 222, 223, 244, 245, 267, 270, 284, 357, 358, 394
  - Rebamipide, 134
  - Receptor activator of nuclear factor- $\kappa$ B ligand (RANKL), 82–85, 94–97, 102, 103
  - Receptor symbol, 2
  - Recovery phase, 319
  - Red blood cell (RBC, erythrocyte), 30, 74, 267, 281, 282, 284, 285, 290, 335
  - Red meat, 150–152
  - Rehydration, 138–141
  - Relapsing remitting multiple sclerosis (RRMS), 47
  - Remineralization, 82, 84, 85
  - Renal damage and scarring, 357

- Renal denervation, 342, 343  
 Renal osteodystrophy, 346  
 Renal stone formation, 351  
 Renal transplantation, 350  
 Renin, 255, 335, 339, 340, 346, 374  
 Renin-angiotensin-aldosterone system (RAAS),  
 182, 183, 251–253, 263, 335, 336, 339,  
 340–342, 345, 346  
 Repair process, 105, 149  
 Reproductive system, 369–377  
 anatomy and physiology  
 of the human breast, 375  
 of the reproductive system, 369  
 final remarks, 376  
 hypothalamus/pituitary/reproductive  
 organ axis, 371  
 menopause, 374–375  
 pregnancy, 372–374  
 reproductive organ-specific metabolic  
 pathways, 369–371  
 signaling in the breast, 375–376  
 signaling of the breast, 376  
 signals  
 from the hypothalamus, 371  
 from the pituitary gland, 372  
 in the reproductive organs, 371  
 from reproductive organs affecting  
 other organs, 372  
 tissue-specific metabolic pathways of the breast, 375  
 Resistance vessel, 14, 262, 265  
 Respiratory acidosis, 211–212  
 Respiratory epithelium, 208–210, 212  
 Respiratory tract, 207, 208, 213, 228  
 Retina, 59–64, 67–71, 73–75  
 Retinal ganglion cell (RGC), 59–61, 64, 73–75  
 Retinal pigment epithelium (RPE), 59, 60, 62–64, 67–70  
 Retinohypothalamic tract, 63  
 Revascularization, 244, 248  
 Rheumatoid arthritis (RA), 115–120  
 circadian rhythms and the immune system, 117–118  
 hypothalamic-pituitary-adrenal axis, 116–117  
 hypothalamic-pituitary-gonadal axis, 117  
 introduction to RA, 115  
 pathophysiology of RA and metabolic alterations,  
 115–116  
 perspectives, 119  
 tailoring RA management: nighttime modified-  
 release glucocorticoid treatment, 118–119  
 vitamin D endocrine system, 117  
 Rotavirus, 139, 145, 148
- S**  
 Saccharolytic fermentation, 150, 151  
 Saphenofemoral ligation, 275  
 Schizophrenia, 17–22  
 influence of treatment on metabolism, 19–20  
 introduction to schizophrenia, 17  
 pathophysiology of schizophrenia and metabolic  
 alterations, 17–18  
 perspectives, 20–21  
 treatment of schizophrenia, 18–19  
 Sclerotherapy, 275  
 Secondary bile acid, 150, 151  
 Secondary hyperparathyroidism, 94, 95, 346  
 Secondary lymphoid tissues, 306–308, 310  
 Secondary progressive multiple sclerosis (SPMS), 47  
 Second-generation antipsychotic (SGA), 18–20  
 Secretase, 37, 38  
 Selective ER downregulator (SERD), 382  
 Selective ER modulator (SERM), 382  
 Selective serotonin reuptake inhibitor (SSRI),  
 14, 15, 44, 147  
 Sensitization phase, 323–324  
 Sepsis, 319–322  
 changes in body composition, 321  
 influence of treatment on metabolism and  
 consequences for patients, 321  
 insulin resistance and stress  
 hyperglycemia, 320–31  
 introduction to sepsis, 319  
 neuroendocrine component, 319–320  
 pathophysiology of sepsis and metabolic  
 alterations, 319  
 perspectives, 322  
 Serotonin (5-HT), 7, 11–15, 19, 20, 43,  
 44, 95, 140, 146, 263  
 Sertoli cell, 369, 371  
 Serum biomarker, 228, 229  
 Set point, 313  
 Sex hormone, 115–117, 369, 375, 383  
 Sex hormone synthesis, 116  
 Shear stress, 83, 265  
 Shivering thermogenesis, 314  
 Short chain fatty acid (SCFA), 123, 125, 150,  
 151, 291  
 Sickle cell disease, 289–293  
 introduction to sickle cell disease, 289  
 introduction to treatment, influence on metabolism,  
 and consequences for patients, 291  
 pathophysiology of sickle cell disease and metabolic  
 alterations, 289–291  
 perspectives, 291–292  
 Sickle cell hemoglobin (HbS), 282, 290  
 Sinoatrial node (SA node), 236  
 Sinusitis, 218  
 Sinusoidal endothelial cell, 173, 174, 176  
 Skeletal disorder, 93  
 Skeleton, 81, 82, 85, 95–97, 193, 209  
 Small intestine, 84, 85, 124, 125, 127, 138, 140,  
 143–146, 151, 157, 158, 160, 285, 286,  
 295–297  
 Smoking cessation, 224  
 Smooth muscle cell, 44, 166, 182, 193, 201, 208, 210,  
 213, 215–217, 224, 236, 240, 244, 246, 247,  
 261, 262, 264, 274, 335, 337  
 Smooth muscle contraction, 145, 264, 325  
 Sodium bicarbonate, 133, 349, 364  
 Sodium glucose linked transporter,  
 143, 144, 163, 168, 332–334

- Sodium glucose linked transporter-2 (SGLT-2) inhibitor, 168
- Somatic recombination, 306
- Somatostatin, 43, 44, 130, 133, 157–159
- Space of Disse, 173, 174
- Sputum specimen, 227
- Statin, 153, 230, 247, 269, 290, 300, 301
- Steroid hormone, 115, 117, 119, 326, 336, 369, 370, 372, 373, 376
- deficiency, 119
- receptor, 372
- Stomach, 123–125, 127, 129, 130, 132, 133, 137, 138, 147, 186, 195, 285, 286
- Storage disorder, 8
- Streptococcus, 227–229
- Stress
- hyperglycemia, 320
- management, 147
- response, 11, 13, 14, 178, 319, 321, 322
- Stroke, 267–271
- influence of treatment on metabolism, 269
- introduction to stroke, 267
- pathological changes in metabolism following stroke onset, 267–269
- perspectives, 270
- secondary treatment options, 269–270
- treatment, 269
- Stromal cell, 193, 308–310
- Strontium ranelate, 96, 97, 111
- Struvite stone, 363, 365
- Stunned myocardium, 244
- Subchondral bone remodeling, 107–109, 111
- Substance P, 7, 43, 44, 263, 265
- Substantia nigra, 5, 9, 29, 30, 32
- Sucralfate, 133
- Sulfonylurea, 159, 167, 168
- Sumatriptan, 44
- Suprachiasmatic nucleus (SCN), 63–64
- Surfactant, 209, 210, 212
- Surgical stone removal, 365
- Sympathetic nervous system (SNS), 251–253
- Sympathetic neuron, 13, 95, 160, 178, 183, 194, 195, 202, 210, 212, 237, 251–253, 262, 320, 321, 335, 340, 342, 346
- Synapse, 6, 7, 25, 31, 35, 36, 38, 54, 61
- Synaptic cleft, 6, 7, 15
- Synovial fluid, 101, 104, 107, 109, 110, 116
- Synovial inflammation, 107–109, 111, 116
- Synovial joint (diarthrosis), 101, 103, 104
- Synovial membrane, 101, 103–105, 107–109
- Synoviocyte, 104, 105, 108, 109
- Synovium, 104, 105
- Synthetic phenotype, 274
- Systemic inflammation, 12, 164, 183, 222, 228, 252, 315
- Systole, 235, 254
- T
- Tau, 35–38
- Taurocholate, 176, 177
- T-cell, 95, 116, 216, 217, 223, 306–309, 324–326, 374
- Teeth, 81–85
- anatomy and physiology of teeth and bone, 81
- bone and tooth: roles in calcium–phosphate homeostasis, 84–85
- calcium and phosphate metabolism and physiological reactions in bone and teeth, 83–84
- calcium metabolism in teeth, 84
- final remarks, 85
- tooth growth, 82–83
- Temperature, 5, 64, 152, 195, 282, 286, 313–316, 320
- Tendon, 103, 104, 298, 299
- Tertiary lymphoid tissue, 305, 308, 309
- Testis, 369–372, 386, 388
- Testosterone, 9, 116, 195, 369–376, 382, 386, 388
- TGR5 activation, 178
- Thalamus, 5, 6, 42, 43
- Theca cell, 371
- T helper cell (T<sub>H</sub>-cell), 306, 324
- Thiazide diuretics, 269, 341, 342, 352, 364
- Thrombocyte (platelet), 281
- Thrombolytic drug, 269, 270
- Thrombosis, 49, 110, 166, 243, 264, 273, 275, 283, 297
- Thrombospondin-1 (TSP-1), 54
- Thrombus formation, 200, 248, 264, 270
- Th2-type asthma, 216–218
- Thyroid dysfunction, 15, 53–55
- Thyroid hormone, 55, 111, 194, 286, 374
- Timolol, 44, 74, 75
- Tiopronin, 362, 365
- Tiotropium bromide, 224, 225
- Tissue plasminogen activator (tPA), 269, 283
- Tobacco, 215, 221–223
- Topical  $\beta$ -blocker, 76
- Trachea, 102, 207, 208, 374
- Translocation of bacteria, 125, 182–184, 228
- Translocation of proteins, 13, 149, 238, 239, 337, 380
- Translucent zone, 88–90
- Transporter symbol, 2
- Trauma, 36, 73, 104, 107, 108, 315
- Tremor, 29, 31, 224
- Triacylglycerol, 191, 200, 201, 241, 285.
- See also* Triglyceride (TG)
- Tri- and tetracyclic antidepressant (TCA), 14, 15
- Tricarboxylic acid (TCA) cycle, 26, 49, 239, 245, 393–398
- Trigemino-cervical complex, 42, 43
- Trigemino-vascular system, 5, 42, 43
- Triglyceride (TG), 13, 14, 76, 173, 175, 191–193, 199–202, 241, 274, 285, 295–301, 341, 375, 394. *See also* Triacylglycerol
- Trimetazidine, 246–247
- Triptan, 44, 146, 147
- Trisomy 21. *See* Down syndrome (DS)
- Tubuloglomerular feedback, 335
- Tumor necrosis factor  $\alpha$  (TNF $\alpha$ ), 13, 43, 95, 105, 108, 109, 115, 116, 118, 130, 164, 165, 175, 182, 193, 194, 200, 222, 223, 229, 253, 264, 314, 315, 320, 324, 382
- Tunica adventitia, 261

Tunica intima, 261  
 Tunica media, 261  
 Type A synoviocyte, 104, 105  
 Type B synoviocyte, 104, 105  
 Type 1 diabetes mellitus (T1DM), 117, 163, 164, 166, 299  
 Type 2 diabetes mellitus (T2DM), 148, 163–165, 167, 199, 202, 265, 299, 342, 359, 383  
 Type 1 pili, 359

## U

Upper airways, 207, 325  
 Urate crystal, 352  
 Urea cycle, 175, 183, 184  
 Urea synthesis, 174, 175  
 Urea transport, 334  
 Uremia, 345, 348, 350, 357, 358  
 Ureterorenoscopy, 363  
 Uric acid, 361–364  
 Uric acid stone, 363, 364  
 Uricase, 351, 353–355  
 Uricosuric, 353–355  
 Urinary tract infection (UTI), 357–360  
   influence of treatment on metabolism, 359  
   introduction to UTI, 357  
   pathophysiology of UTI and metabolic alterations, 357–359  
   perspectives, 359–360  
   treatment, 359  
 Urine, 94, 127, 163, 175, 176, 192, 285, 286, 331–335, 347, 348, 350, 355, 357, 359, 361–365  
 Urine pH, 363, 364  
 Uropathogen, 357–360  
 Uropathogenic *Escherichia coli*, 357

## V

Valproic acid, 24, 25, 44  
 Valve, 235, 236, 263, 273  
 Varicose veins, 273–277  
   histological changes, 274  
   introduction to varicose veins, 273  
   metabolic changes, 275  
   molecular changes, 274–275  
   pathophysiology of varicose veins and metabolic alterations, 273  
   perspectives, 276  
   pharmacological treatments and their influence on metabolism, 275–276  
   treatment, 275  
 Vascular endothelial growth factor (VEGF), 51, 68–71, 130, 153, 193, 274

Vasoactive intestinal peptide (VIP), 43, 181, 183  
 Vasoconstriction, 44, 166, 186, 212, 213, 228, 251, 252, 255, 264, 286, 290, 291, 314, 335, 340  
 Vasodilation, 42–44, 130, 166, 182, 183, 185, 202, 240, 246, 247, 264, 265, 342  
 Vasodilator, 42, 183, 228, 229, 240, 246, 263, 264, 276, 341, 342  
 Vasoocclusion, 289–291  
 Vasopressin (antidiuretic hormone, ADH), 8, 182, 183, 186, 252, 332–334, 336, 337, 371  
 Vasoregulation, 262, 263, 265  
 VEGF inhibition, 68, 69  
 Vein, 42, 45, 61, 74, 173, 177, 181, 184, 200, 208, 235, 236, 261, 263–265, 273–276, 331–333  
 Vein wall hypoxia, 274  
 Venoactive drug, 275  
 Venous valve failure, 273  
 Ventilation, 209–213, 228, 230, 374  
 Ventilation-perfusion ( $V_A/Q$ ) mismatching, 228  
 Ventricle, 18, 50, 235, 236, 240, 251, 261  
 Verapamil, 44, 340  
 Very-low-density lipoprotein (VLDL), 201, 202, 295–299  
 Vigabatrin, 24, 25  
 Villus, 126, 139  
 Virus, 139–141, 145, 148, 164, 184, 215, 227, 229, 308–310, 315  
 Visceral fat, 13, 199–202, 341, 386  
 Visceral obesity, 11, 12, 200, 201  
 Vision, 59, 67, 70, 73, 74  
 Vitamin A, 61, 64, 173  
 Vitamin D endocrine system, 115, 117  
 Vitreous body, 60  
 Vomiting, 38, 41, 44, 110, 127, 129, 131, 137, 138, 140, 143, 146, 147, 323, 374

## W

Warburg effect, 393, 394, 396  
 Weight gain, 15, 20, 31, 32, 44, 168, 339, 341, 342, 382, 398  
 White adipose tissue (WAT), 164, 191–193, 265  
 White blood cell (leukocyte), 281, 321

## X

Xanthine oxidase, 351–353

## Z

Zolmitriptan, 44